

1394MP13
New In Stock!
Allen Bradley

<http://www.pdfsupply.com/automation/allen-bradley/automation/1394MP13>

automation
1-919-535-3180

PANEL

www.pdfsupply.com

Email: sales@pdfsupply.com

- Initial development goals for PLCs include:
 - Elimination of the high cost associated with changes in wiring in electromechanical relay control systems generally experienced during installations.
 - Reduction of downtime caused by mechanical failures and system changes.
- Additional benefits included:
 - Improvements in system efficiency
 - Enhancement of product quality
 - The ability to provide access to process information
 - Easy installation
 - Use of less space and energy
 - Being reusable for other applications.
- Some of the most important characteristics of programmable controllers include:
 - Solid state components
 - Flexible architecture, or configuration, of input and output interfaces
 - Built to sustain harsh industrial environments.
- The basic operation of the PLC is to:
 - Read the input status of field input devices
 - Execute the control program stored in the PLC
 - Update or control the field output devices according to the control logic
- The operation of reading the inputs, executing the program and updating the outputs is known as the SCAN.
- Programmable controllers come in many sizes to accommodate different applications according to the number of field devices to be connected and by the functions to be performed to provide control.
- When PLCs were first developed, one of the primary intentions was to have its programming language (ladder diagrams) similar to the one used in relay systems which PLCs were to replace. This allowed for easier use of PLCs in relay replacement applications to personnel already familiar with ladder diagrams.
- The PLC's ladder diagram language references or *addresses* input and output (I/O) field devices connected to the controller via I/O interfaces.

1-4 VIDEO GUIDE

Notes

Definition And Background



PLC Application Concept

Principles of Operation



PLC Basic Concepts

Relay Logic and The PLC

Notes



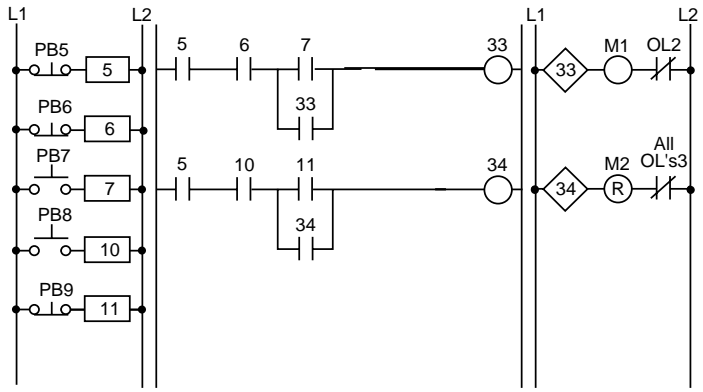

Ladder Diagram and The PLC (Addressing)

Notes





1-5 REVIEW QUESTIONS

- 1-1 True/False. A programmable controller can be considered as a special member of the computer family.
- 1-2 Sketch the conceptual operation of a PLC that includes its measuring and control of a process or machine.
- 1-3 Which of the following was not one of the primary goals associated with the development of PLCs.
- a-To eliminate hardwired relay systems
 - b-To reduce machine downtime
 - c-To ease troubleshooting
 - d-To replace mainframe computers
 - e-To ease system changes (e.g., programming)
- 1-4 True/False. PLCs use more energy than electromechanical systems.
- 1-5 Programmable controllers work hand-in-hand with _____ and _____ in industrial automation facilities.
- a-Diagnostic indicators
 - b-Robots
 - c-Management Information Systems
 - d-Hardware timers
- 1-6 True/False. Programmable controllers can be used in virtually all sorts of industrial applications.
- 1-7 The CPU is composed of _____, _____ and _____.
- a-I/O Modules
 - b-Processor
 - c-Programming Device
 - d-Memory
 - e-Power Supply
- 1-8 Name three typical output field devices that are controlled by a PLC via output interfaces.

- 1-9 True/False. The operation of a PLC in basic terms is reading the inputs, executing the control program and updating the outputs.
- 1-10 The purpose of the I/O interfaces is to _____ the various signals received from or sent to external field devices.
- a–Sense and control
b–Provide isolation to
c–Condition
d–All of the above
- 1-11 Match the following:
- | | | |
|-----|--|----------------------|
| ___ | Handheld unit | a–CRT |
| ___ | Self-contained video display | b–Mini-Programmer |
| ___ | Used to program PLCs but are not dedicated units | c–Personal Computers |
- 1-12 True/False In the early days, PLCs were encountered in two major types: Small PLCs and large PLCs.
- 1-13 True/False. Very large PLCs are powerful controllers capable of utilizing up to 8192 I/O field devices.
- 1-14 True/False. There is a lot of similarity in the way electrical controlled sequences are represented in PLCs.
- 1-15 True/False. In Figure1, the pilot light will be on if PB1 and LS1 are on, or if LS2 and LS1 are both on.



Figure1

1

1-16 In Figure 2, the PL output coil in the ladder diagram will turn ON if PB1 and LS1 are ON or if _____.

- a–PB1 is disconnected
- b–LS2 and LS1 are ON
- c–LS1 closes
- d–All of the above



Figure 2

1-17 When it is said that field devices are addressed by their respective input and output interface module, it refers to:

- a–Remote I/O locations and wiring
- b–The PLC’s ability to read inputs, execute the instructions and update the outputs
- c–Each programmed element (contact and coil) is represented by the connection location of each field device in a PLC module
- d–The actual wiring of the field devices in the control panel

1-18 True/False. In Figure 2, the actual pilot light will be turned ON right after the processor updates the outputs.

1-19 True/False. In Figure 2, if PB1 was ON and then released and LS1 is closed, the light will be on.

1-20 True/False. In Figure 2, we can say that the programmed instructions are wired so to speak, inside the PLC.

1-6 HOW DID YOU DO?

1-1 True.

1-2 Conceptual design sketch.



1-3 d.- To replace mainframe computers.

1-4 False. PLCs use less energy and space than electromechanical relay systems.

1-5 b.-Robots
c.-Management Information Systems (MIS)

1-6 True.

1-7 b.-Processor
d.-Memory
e.-Power Supply.

1-8 Solenoids, motor starters, pilot lights, etc.

1-9 True.

1-10 d.- All of the above.

1-11	<u>b</u>	Handheld unit	a-CRT
	<u>a</u>	Self-contained video display	b-Mini-Programmer
	<u>c</u>	Used to program PLCs but	c-Personal Computers
	___	are not dedicated units	a-CRT
	___	Self-contained video display	b-Mini-Programmer
	___	Used to program PLCs but	c-Personal Computers
		are not dedicated units	

- 1-12 True.
- 1-13 True.
- 1-14 True.
- 1-15 True.
- 1-16 b.- LS2 and LS1 are ON
- 1-17 c.-Each programmed element (contact and coil) is represented by the connection location of each field device in a PLC module.
- 1-18 True.
- 1-19 False. There must be power continuity for the light to be on. PB1 breaks the power continuity.
- 1-20 True.