

AlspaIC670MDL233
New In Stock!
Cegelec Alstom Alspa

<http://www.pdfsupply.com/automation/cegelec-alstom-alspa/alspa-ce80-20/AlspaIC670MDL233>

Alspa CE80-20
1-919-535-3180

Alstom Alspa In Stock! 120VAC Input, 8 Point, Isolated IC670M
IC670MD IC670MDL Cegelec

www.pdfsupply.com

Email: sales@pdfsupply.com

**Alspa CE80–20
FIP Bus Interface
Unit User's Manual**

ALS 52311 b-en

First issue: 08–96
This edition: 02–98

Meaning of terms that may be used in this document / Notice to readers

WARNING

Warning notices are used to emphasize that hazardous voltages, currents, temperatures, or other conditions that could cause personal injury exist or may be associated with use of a particular equipment.

In situations where inattention could cause either personal injury or damage to equipment, a Warning notice is used.

Warning notices are used to emphasize that hazardous voltages, currents, temperatures, or other conditions that could cause personal injury exist or may be associated with use of a particular equipment.

In situations where inattention could cause either personal injury or damage to equipment, a Warning notice is used.

Caution

Caution notices are used where there is a risk of damage to equipment for example.

Note

Notes merely call attention to information that is especially significant to understanding and operating the equipment.

This document is based on information available at the time of its publication. While efforts have been made to be accurate, the information contained herein does not purport to cover all details or variations in hardware or software, nor to provide for every possible contingency in connection with installation, operation, or maintenance. Features may be described herein which are not present in all systems. Cegelec assumes no obligation of notice to holders of this document with respect to changes subsequently made.

Cegelec makes no representation or warranty, expressed, implied, or statutory with respect to, and assumes no responsibility for the accuracy, completeness, sufficiency, or usefulness of the information contained herein. Cegelec gives no warranties of merchantability or fitness for purpose shall apply.

In this publication, no mention is made of rights with respect to trademarks or tradenames that may attach to certain words or signs. The absence of such mention, however, in no way implies there is no protection.

Partial reproduction of this document is authorized, but limited to internal use, for information only and for no commercial purpose.

However, such authorization is granted only on the express condition that any partial copy of the document bears a mention of its property, including the copyright statement.

All rights reserved
© Copyright 1997, Cegelec, Levallois-Perret (France)

Revisions

Index letter	Date	Nature of revision
b	02-98	Availability of V2 of FIP BIU (changes to functional specifications, operation and I/O modules available).

Revisions

1. CONTENT OF THIS MANUAL

This manual describes the Alspa CE80–20 FIP Bus Interface Unit. It explains operation of the Bus Interface Unit as a FIP bus device (CE670FBI001/FBI002).

Chapter 1. Introduction: Chapter 1 introduces Alspa CE80–20 systems, the FIP Bus Interface Unit, the Bus Interface Unit Power Supply, and the Bus Interface Unit Terminal Block, and lists their specifications.

Chapter 2. Installation: Chapter 2 describes Bus Interface Unit installation and gives system installation guidelines.

Chapter 3. Operation: Chapter 3 explains how a Bus Interface Unit interacts with the modules in its station, how it stores data, and how it exchanges data with a PLC or other type of system host.

Chapter 4. Hand-held Programmer Functions: Chapter 4 explains how to use a Hand-held Programmer with a FIP Bus Interface Unit.

2. RELATED PUBLICATIONS

For more information, refer to these publications:

ALS 52308 Alspa CE80–20 I/O Modules User's Manual. This book describes Alspa CE80–20 I/O Modules and I/O Terminal Blocks and explains how to install them.

ALS 52310 FIP Bus Controller (FBC) for Alspa C80–75 PLC User's Manual. Reference manual for the Bus Controller, which interfaces a FIP bus to an Alspa C80–75 PLC. This book describes the installation and operation of the Bus Controller. It also contains the programming information needed to interface FIP devices to an Alspa C80–75 PLC.

Preface

3. MANUAL NUMBERS

In some cases, Alspa 8000 manuals may be issued with numbers that differ from the one given under "Related Publications" in the Preface of other manuals, or in Important Product Information or data sheets.

The contents are similar.

The table below shows the correspondence between "ALS" and equivalent numbers for the manuals concerned:

<i>ALS Number</i>	<i>Other Number</i>	<i>ALS Number</i>	<i>Other Number</i>
<i>ALS 52113</i>	<i>GFK-0600</i>	<i>ALS 52507</i>	<i>GFK-0074</i>
<i>ALS 52302</i>	<i>GEK-90486-2</i>	<i>ALS 52508</i>	<i>GFK-0868</i>
<i>ALS 52303</i>	<i>GFZ-0043</i>	<i>ALS 52514</i>	<i>GFK-0870</i>
<i>ALS 52404</i>	<i>GFK-0415</i>	<i>ALS 52515</i>	<i>GFK-1026</i>
<i>ALS 52405</i>	<i>GFK-0819</i>	<i>ALS 52523</i>	<i>GFK-1063</i>
<i>ALS 52503</i>	<i>GFK-0585</i>	<i>ALS 52603</i>	<i>GFK-0450</i>

4. WE WELCOME YOUR COMMENTS AND SUGGESTIONS

Cegelec strives to produce quality technical documentation. Please take the time to fill in and return the "Reader's Comments" page if you have any remarks or suggestions

ALS 52311 b-en Alspa CE80-20 FIP Bus Interface Unit User's Manual

Your main job is:

- | | |
|--|--|
| <input type="checkbox"/> System designer | <input type="checkbox"/> Programmer |
| <input type="checkbox"/> Distributor | <input type="checkbox"/> Maintenance |
| <input type="checkbox"/> System integrator | <input type="checkbox"/> Operator |
| <input type="checkbox"/> Installer | <input type="checkbox"/> Other (specify below) |

If you would like a personal reply, please fill in your name and address below:

COMPANY: NAME:
ADDRESS:
..... COUNTRY:

Send this form directly to your CEGELEC sales representative or to this address:

**Cegelec
Technical Documentation Department (TDD)
5 avenue Newton BP 215
92142 Clamart Cedex
France
Fax: +33 (0)1 46 29 12 44**

All comments will be considered by qualified personnel.

REMARKS

Continue on back if necessary.

Reader's comments

CHAPTER 1 – INTRODUCTION	1-1
1. OVERVIEW	1-1
2. ALSPA CE80-20 MODULES	1-3
2.1. FIP Bus Interface Unit	1-4
2.2. Bus Interface Unit Terminal Block	1-4
2.3. I/O Modules	1-4
2.4. I/O Terminal Blocks and Auxiliary I/O Terminal Blocks	1-4
2.5. Further information	1-4
3. LOCATIONS FOR ALSPA CE80-20	1-5
4. ALSPA CE80-20 ENVIRONMENTAL SPECIFICATIONS	1-6
4.1. Installing Alspa CE80-20 modules	1-6
5. FIP BUS INTERFACE UNIT	1-7
5.1. Bus Interface Unit Power Supply	1-7
5.2. Timing	1-8
5.3. Calculating Input Power Requirements for a Bus Interface Unit	1-8
6. BUS INTERFACE UNIT TERMINAL BLOCK	1-10
7. BUS INTERFACE UNIT FUNCTIONAL SPECIFICATIONS	1-11
8. HAND-HELD PROGRAMMER	1-12
9. ALSPA C80-75 PLC: REQUIREMENTS	1-13
10. CONFIGURATION	1-14
10.1. Hand-Held Programmer Configuration	1-14
10.2. Network Configuration	1-14
CHAPTER 2 – INSTALLATION	2-1
1. PRE-INSTALLATION CHECK	2-2
2. STATIC PROTECTION	2-2
3. REMOVING THE BUS INTERFACE UNIT FROM THE TERMINAL BLOCK	2-3
4. INSTALLING THE DIN RAIL	2-4
5. INSTALLING THE BUS INTERFACE UNIT TERMINAL BLOCK ON THE DIN RAIL	2-5

Contents

6.	INSTALLING THE CABLES BETWEEN TERMINAL BLOCKS	2-6
7.	SETTING THE BIU DIP SWITCHES	2-7
8.	INSTALLING THE BUS INTERFACE UNIT ON THE TERMINAL BLOCK	2-8
9.	SYSTEM WIRING GUIDELINES	2-9
10.	SYSTEM GROUNDING	2-10
11.	POWER WIRING TO THE BUS INTERFACE UNIT	2-11
12.	CONNECTING THE COMMUNICATIONS BUS	2-12
13.	OBSERVING THE LEDS	2-13
14.	REMOVING/REPLACING THE BUS INTERFACE UNIT FUSE	2-14
15.	REMOVING THE BUS INTERFACE UNIT TERMINAL BLOCK FROM THE DIN RAIL .. 2-15	
CHAPTER 3 – OPERATION		3-1
1.	OPERATION	3-1
2.	OPERATING MODES OF THE BUS INTERFACE UNIT	3-2
3.	IDLE MODE	3-3
4.	READY MODE	3-4
5.	RUN MODE	3-5
6.	I/O DATA	3-6
6.1.	Discrete Inputs	3-7
6.2.	Discrete Outputs	3-9
6.3.	Analog Inputs	3-11
6.4.	Analog Outputs	3-13
7.	DIAGNOSTICS	3-15
7.1.	Status Data Transmitted by the Bus Interface Unit	3-15
7.2.	I/O module validators	3-15
7.2.1.	Discrete and analog modules	3-16
7.2.2.	Smart modules	3-16
7.2.3.	Bus Interface Unit Status Data Format	3-17

CHAPTER 4 – HAND-HELD PROGRAMMER FUNCTIONS	4-1
1. USING THE HAND-HELD PROGRAMMER	4-2
1.1. HHP Displays	4-2
1.2. Menu Overview	4-3
2. DISPLAYING AND EDITING CONFIGURATION DATA	4-4
3. DISPLAYING THE BUS INTERFACE UNIT CONFIGURATION	4-5
4. CONFIGURING I/O MODULES	4-6
4.1. Reading a Module Configuration	4-7
4.2. Configuring an Empty Slot	4-7
4.3. Configuring a Discrete Input Module	4-8
4.3.1. Report Faults	4-8
4.3.2. Default Inputs or Hold Last State	4-10
4.4. Configuring a Discrete Output Module	4-10
4.4.1. Default Outputs or Hold Last State	4-10
4.4.2. Report Faults	4-11
4.5. Configuring an Analog Input Module	4-11
4.5.1. Default Inputs or Hold Last Values	4-11
4.5.2. Fault Reporting	4-12
4.5.3. Channel Active	4-12
4.5.4. Input Current/Voltage Ranges	4-12
4.5.5. Input Scaling	4-13
4.5.6. Alarm Thresholds	4-14
4.6. Configuring an Analog Output Module	4-15
4.6.1. Default Outputs or Hold Last Values	4-15
4.6.2. Fault Reporting	4-15
4.6.3. Channel Active	4-16
4.6.4. Output Current/Voltage Ranges	4-16
4.7. Output Scaling	4-17
5. MONITORING AND FORCING I/O DATA	4-18
5.1. Looking at I/O Data	4-18
5.2. Changing the Data Display Format: Binary, Hex, Decimal	4-18
5.3. Forcing and Unforcing Data	4-19
6. DISPLAYING AND CLEARING FAULTS	4-20
6.1. Displaying Faults	4-20
6.2. Clearing Faults	4-20
7. ERASING FLASH MEMORY	4-21

Chapter *Introduction*

1

This chapter introduces Alspa CE80–20 modules, the FIP Bus Interface Unit, and other equipment that may be used with the Bus Interface Unit. It will help you locate more information in other Alspa CE80–20 and FIP documents.

1. OVERVIEW



**Alspa
CE80–20
Station**

Alspa CE80–20 is a family of highly-modular distributed I/O and control products. They are suitable for use in a wide range of host architectures.

The heart of the Alspa CE80–20 system is the Bus Interface Unit. The Bus Interface Unit provides intelligent processing, I/O scanning, and feature configuration for a group of up to eight I/O modules. Together, the Bus Interface Unit and its modules make up an Alspa CE80–20 station (see the illustration, left).

The Bus Interface Unit and I/O modules are enclosed in sturdy, compact aluminum housings. The Bus Interface Unit and I/O modules bolt securely to separate Terminal Blocks, which provide all field wiring terminals. The I/O Terminal blocks are generic and allow different I/O module types to be mounted on the same base. I/O Terminal Blocks are available with either box-type or barrier-type terminals. All Terminal Blocks must be mounted on a DIN rail. The DIN rail, which serves as an integral part of the grounding system, can also be mounted on a panel.

Alspa CE80–20 Features

Features and benefits of Alspa CE80–20 include:

- wiring savings,
- better up time,
- easy installation and maintenance,
- spare parts savings,
- low cost,
- feature flexibility,
- open architecture / adaptable to a variety of networks,
- distributed I/O,
- small, compact I/O modules with generic terminal wiring bases,
- DIN rail mounted.

List of modules available with FIP bus

Number	FIP BIU V1	FIP BIU V2
Discrete Input		
IC670MDL233	no	no
IC670MDL240	yes	yes
IC670MDL241	yes	yes
IC670MDL640	yes	yes
IC670MDL641	yes	yes
IC670MDL642	yes	yes
IC670MDL643	yes	yes
IC670MDL644	yes	yes
Discrete Output		
IC670MDL330	yes	yes
IC670MDL331	yes	yes
IC670MDL730	yes	yes
IC670MDL740	yes	yes
IC670MDL742	yes	yes
IC670MDL930	yes	yes
Analog Input		
IC670ALG230	yes	yes
IC670ALG240	no	yes
IC670ALG620	no	yes
IC670ALG630	no	yes
Analog Output		
IC670ALG320	yes	yes
IC670ALG330	no	yes

2. ALSPA CE80–20 MODULES

There are three basic types of Alspa CE80–20 modules:

- **Bus Interface Unit.** The illustration below shows a FIP Bus Interface Unit.
- **I/O modules**
- **Terminal Blocks:**
 - Bus Interface Unit Terminal Block.
 - I/O Terminal Blocks, each of which accommodates two I/O modules.
 - Auxiliary Terminal Blocks. These optional terminal strips can be connected to the side of an I/O Terminal Block if extra common terminals are needed.



2.1. FIP Bus Interface Unit

The FIP Bus Interface Unit interfaces Alspa CE80–20 I/O modules to a FIP bus.

The intelligent processing capabilities of the FIP Bus Interface Unit allow the configuration of features such as fault reporting, selectable input and output defaults, analog scaling and analog range selection for the modules in the station. In addition, the FIP Bus Interface Unit performs diagnostic checks on itself and its I/O modules, and relays diagnostic information to the host (if configured for fault reporting) and to a Hand–Held Programmer.

The Bus Interface Unit mounts on a Bus Interface Unit Terminal Block. The Bus Interface Unit can be removed and replaced if necessary without removing the wiring or reconfiguring the I/O station.

2.2. Bus Interface Unit Terminal Block

The Bus Interface Unit Terminal Block provides connections for power wiring and single or dual communications cables. The Bus Interface Unit Terminal Block stores the configuration parameters selected for the station.

2.3. I/O Modules

Alspa CE80–20 I/O Modules are available in many types to suit a wide range of application needs. Modules can be installed and removed without disturbing field wiring. One or two I/O modules may be mounted on an I/O Terminal Block.

2.4. I/O Terminal Blocks and Auxiliary I/O Terminal Blocks

An I/O Terminal Block provides mounting, electrical, and field wiring connections. Each half of the I/O Terminal Block can be mechanically keyed to accept only an I/O module of a specific type. Auxiliary I/O Terminal Blocks can be easily attached to an I/O Terminal Block. They provide the extra connections needed for analog and high-density discrete modules.

2.5. Further information

For more information, please refer to:

Chapter 2: Installation, which explains wiring to the Bus Interface Unit, and explains how to install the Bus Interface Unit module on the Field Terminal Block.

Chapter 3: Operation, which explains how the FIP Bus Interface Unit services I/O.

The *ALS 52308 Alspa CE80–20 I/O Modules User's Manual*, which describes I/O modules and I/O Terminal Blocks. This manual also explains module installation and field wiring.

3. LOCATIONS FOR ALSPA CE80–20

The FIP Bus Interface Unit and Alspa CE80–20 I/O modules can be located on equipment, in junction boxes, inside panels, behind operator stations, and in other locations where space is limited. The area should be clean, free of airborne contaminants, and provide adequate cooling. Alspa CE80–20 modules can be installed in NEMA enclosures. The enclosure can be as little as 10.16 cm (4 inches) deep. A 35mm x 7.5mm DIN rail is required.

The Bus Interface Unit Terminal Block and up to four I/O Terminal Blocks are grouped together using the connection cables provided. All of the I/O Terminal Blocks in a group must be connected either before or after the Bus Interface Unit. A Bus Interface Unit may not be connected between I/O Terminal Blocks.



Terminal Blocks can be mounted in any orientation without derating the modules' temperature specification.

4. ALSPA CE80–20 ENVIRONMENTAL SPECIFICATIONS

Vibration Modules perform well where vibration is a factor. Modules are installed on a panel-mounted DIN rail using the clamp supplied, and with the panel-mounting feet secured. For information about vibration standards, please see the *ALS 52612 Installation Requirements for Conformance to Standards*.

Noise Modules are resistant to noise levels found in most industrial applications when installed according to accepted practices, including proper separation of wiring by voltage and power level. Modules must be installed on a conductive (unpainted) DIN rail. The DIN rail is an integral part of the grounding system.

Modules are tested to the specifications listed in the *ALS 52612 Installation Requirements for Conformance to Standards*.

Temperature Modules operate reliably in ambient air temperatures from 0°C (32°F) up to 55°C (131°F). Storage temperatures are –40°C (–40°F) to +85°C (185°F).

Humidity 5% to 95%, non-condensing.

4.1. Installing Alspa CE80–20 modules

For information about installing Alspa CE80–20 modules, please see:

Chapter 2 of this manual. It describes installation and wiring for the Bus Interface Unit module and terminal block.

Chapter 2 of the *ALS 52308 Alspa CE80–20 I/O Modules User's Manual*. It summarizes installation instructions for modules and terminal blocks. Detailed installation instructions are also packed with individual Alspa CE80–20 modules.

The individual module datasheets included in the *ALS 52308 Alspa CE80–20 I/O Modules User's Manual*, which provide specific module wiring information.

5. FIP BUS INTERFACE UNIT

The FIP Bus Interface Unit is a small, rugged, intelligent module with a sturdy aluminum housing. The module has four status LEDs and a connector for a Hand-Held Programmer.



The Bus Interface Unit requires an external source of 24 VDC power.

The BIU's internal power supply provides power for the operation of the BIU itself, and logic power for the I/O modules connected to it.

It mounts on a separate terminal block, to which it and all field wiring are attached. The configuration is stored in non-volatile memory located in the terminal block.

The Bus Interface Unit has a replaceable 1A, 5x20 mm 250 VAC slow-blow fuse on the input power lines. The fuse can be changed without disturbing the wiring of any other modules.

5.1. Bus Interface Unit Power Supply

The 24 VDC power supply in the Bus Interface Unit provides power for the Bus Interface Unit itself and logic power for all I/O modules that may potentially be installed at that station.

External power must be supplied for input and output devices.

The BIU power supply is not damaged by either of the following:

- Reversing input voltage on terminals 1 and 2.
- *Temporary* overcurrent conditions on the 6.5 VDC output.

5.2. Timing

The Bus Interface Unit provides power to all I/O modules that are installed at the station. I/O module operation is governed by a System Reset signal to ensure controlled operation during the power up and shut down processes. As shown in the timing diagram below, momentary power losses of less than 10 milliseconds do not affect I/O module operation; however, longer power losses generate a Reset for all system I/O modules.

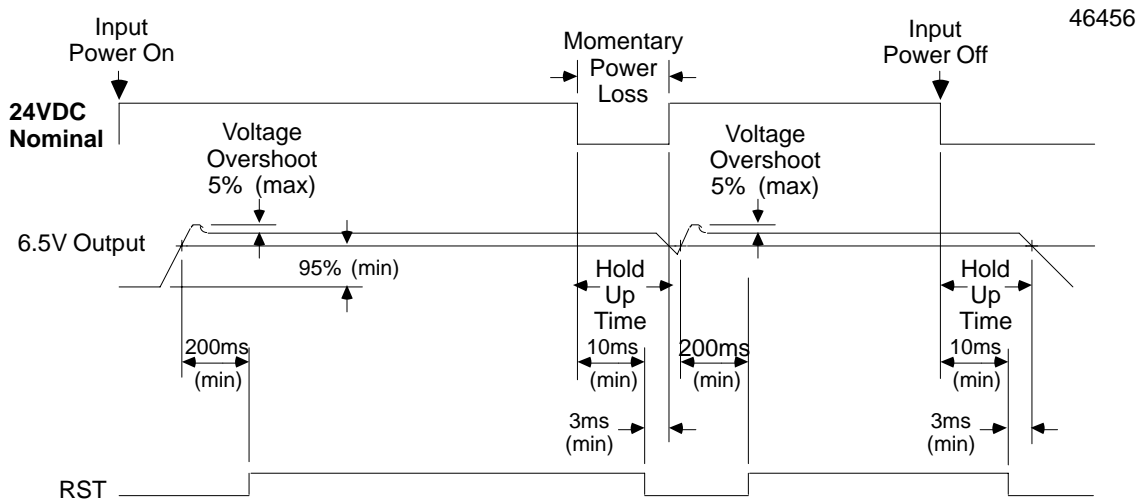

5.3. Calculating Input Power Requirements for a Bus Interface Unit

The chart below shows typical input power requirements for the 24 VDC power supply.

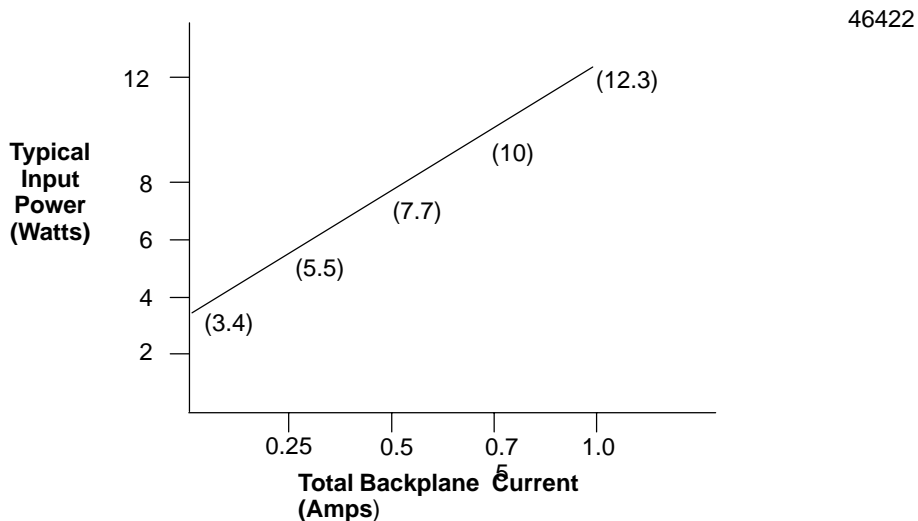

Note

Start-up surge at full load is 15–50 Amps for 3 milliseconds (maximum).

To determine specific system requirements:

- Determine total output load from typical specifications listed for individual modules.
- Use the graph above to determine average input power.
- Divide the input power by the operating source voltage to determine the input current requirements.
- Use the lowest input voltage to determine the maximum input current.
- Allow for startup surge current requirements. Startup surge current levels are a function of source impedance and, therefore, are installation-dependent. Startup surge currents can vary between 25A and 50A for approximately 3 ms.
- Allow margins (10% to 20%) for variations.

6. BUS INTERFACE UNIT TERMINAL BLOCK

The Bus Interface Unit provides terminals for power and ground connections. Maximum wire size is 2.10 mm² AWG No.14.

The Bus Interface Unit Terminal Block also has two connectors for attachment to a single or dual FIP bus.

A connecting cable is provided with each I/O Terminal Block. It is used to connect the Bus Interface Unit Terminal Block to the first I/O Terminal Block. The same type of cable interconnects subsequent I/O Terminal Blocks. The cable has molded connectors that are keyed to assure proper orientation.

The Bus Interface Unit Terminal Block stores the configuration parameters for the station. The Bus Interface Unit can be removed without removing the wiring or reconfiguring the station.

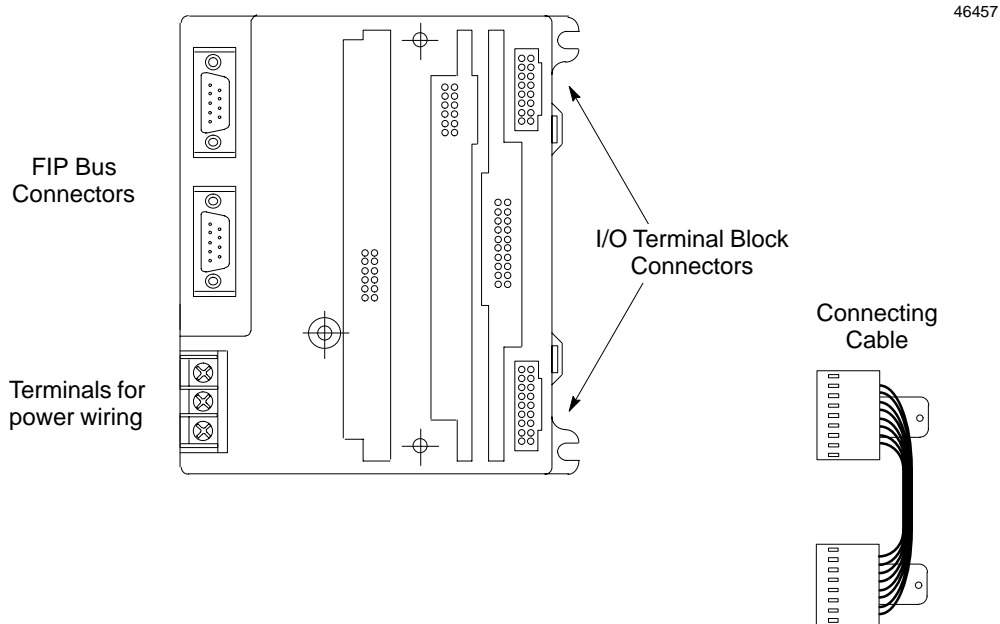

Specifications for the Bus Interface Unit terminal block are listed on §7. Wiring information is in chapter 2, § 9.

7. BUS INTERFACE UNIT FUNCTIONAL SPECIFICATIONS

Bus Interface Unit:	
Reliability :	More than 200000 hours operation MTBF, calculated
Power-supply :	
Power Supply Input	
Nominal Rated Voltage	24 VDC
Voltage Range	18 VDC to 30 VDC
Power	16.8 Watts maximum at full load (nominal voltage)
Inrush Current	15–50 Amps peak, 3 ms maximum (see note)
Power Supply Output	
To CPU and communications:	5.0 VDC +/- 3.5% Current required: 0 to 0.42 Amp (0.40 Amp typical)
To Hand-Held Programmer:	6.5 VDC +/-5% Current required: 0 to 0.193 Amp maximum with Hand-Held Programmer (0.013 Amp typical) 85 mWatt typical, 1.25 Watt maximum
To I/O modules:	6.5 VDC ±5% 1.0 Amp maximum
Holdup Time	10 ms maximum
FIP Network :	
Data rate:	1 or 2.5 Mbit/sec (according to board reference number FBI001 or FBI002)
Protocol:	FIP or World FIP (set by built-in dipswitch)
Bus Address:	0 to 127 decimal (set by built-in dipswitch)
Bus Interface Unit Terminal Block:	
Power Requirements	16 mA maximum
Reliability	More than 600 000 hours operation MTBF, calculated

For information about I/O modules, please see the *ALS 52308 Alspa CE80–20 I/O Modules User's Manual*.

Note

Inrush current is installation dependent. See page 1–8, § 5.3..

For information about installing I/O modules, see the *ALS 52308 Alspa CE80–20 I/O Modules User's Manual*.

8. HAND-HELD PROGRAMMER

The Hand-Held Programmer provides a convenient portable operator interface to the Bus Interface Unit and I/O modules.



The Hand-Held Programmer can be used to monitor, force, and unforce I/O, and to display diagnostics.

For more information, please see:

Chapter 4, Hand-Held Programmer Functions.

The *ALS 52202 Hand-Held Programmer for Alspa C80-35, C80-25 and C80-05 PLCs User's Manual* for basic HHP operating instructions.

9. ALSPA C80–75 PLC: REQUIREMENTS

For a FIP Bus Interface Unit used in an Alspa C80–75 PLC system, the following are required:

- Alspa C80–75 CPU version 6 or later.
- Alspa P8–75 programming and configuration software release 6 or later.
- Alspa C80–75 FIP Bus Controller.

10. CONFIGURATION

The FIP Alspa CE80–20 I/O Station may be configured in two ways.

- temporarily with a Hand–Held Programmer.
- over the FIP network.

10.1. Hand–Held Programmer Configuration

A Hand–Held Programmer can be used to temporarily configure I/O modules so I/O data can be monitored, forced and unforced, before the Bus Interface Unit is operational on the FIP network.

For more information about this type of configuration see **Chapter 4, Hand–Held Programmer Functions**.

10.2. Network Configuration

A Network Configuration must be received before the Bus Interface Unit can exchange I/O data on the network. Until it has a valid configuration, the Bus Interface Unit is only capable of identifying itself on the network, then accepting the configuration supplied.

For more information about this type of configuration see the *ALS 52310 FIP Bus Controller (FBC) for Alspa C80–75 PLC User's Manual*.

Chapter *Installation*

2

This chapter describes installation procedures for the Bus Interface Unit.

- Preinstallation Check
- Static Protection
- Removing the Bus Interface Unit from the Terminal Block
- Installing the DIN Rail
- Installing the Bus Interface Unit Terminal Block on the DIN Rail
- Installing the Cables Between Terminal Blocks
- Setting the BIU DIP Switches
- Installing the Bus Interface Unit on the Terminal Block
- System Wiring Guidelines
- System Grounding
- Power Wiring to the Bus Interface Unit
- Connecting the Communications Bus
- Observing the LEDs
- Removing/Replacing the Bus Interface Unit Fuse
- Removing the Bus Interface Unit Terminal Block from the DIN Rail

1. PRE-INSTALLATION CHECK

Carefully inspect all shipping containers for damage during shipping. If any part of the system is damaged, notify the carrier immediately. The damaged shipping container should be saved as evidence for inspection by the carrier.

As the consignee, it is your responsibility to register a claim with the carrier for damage incurred during shipment. However, Cegelec will fully cooperate with you, should such action be necessary.

After unpacking the Alspa CE80-20 modules and other equipment, record all serial numbers. Serial numbers are required if you should need to contact Product Service during the warranty period of the equipment.

All shipping containers and all packing material should be saved should it be necessary to transport or ship any part of the system.

2. STATIC PROTECTION

The Bus Interface Unit has CMOS components that are susceptible to static damage. *Use proper static handling techniques when handling this module.*

3. REMOVING THE BUS INTERFACE UNIT FROM THE TERMINAL BLOCK

The Bus Interface Unit is shipped pre-installed on the BIU Terminal Block.

Remove it to set the BIU DIP switches and to install the connector cable to the first I/O Terminal Block.

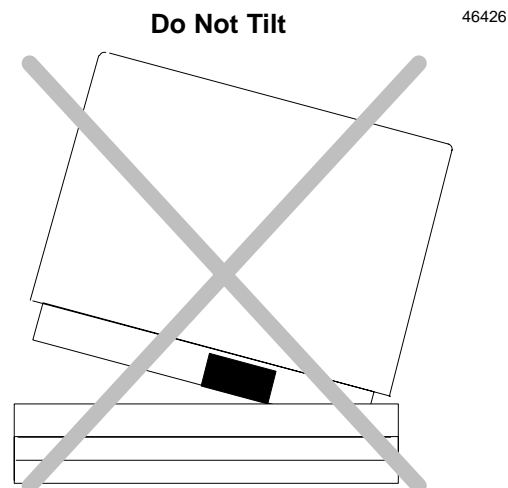

1. Loosen the Bus Interface Unit retaining screws.

Caution

Be sure screws are fully disengaged. Attempting to remove the module with screw(s) partially engaged may damage it.

2. Pull the Bus Interface Unit module straight away from the Terminal Block.

Caution

Do not tilt the Bus Interface Unit to remove it. Attempting to remove the Bus Interface Unit at an angle may damage it.

4. INSTALLING THE DIN RAIL

All Alspa CE80–20 Terminal Blocks must be mounted on a 7.5mm x 35mm DIN rail. The rail must have a conductive (unpainted) finish for proper grounding. For best vibration resistance, the DIN rail should be installed on a panel using screws spaced approximately 15.24 cm (6 inches) apart. When using multiple rail sections, be sure they are properly aligned. Mount the DIN rail at least 10.80 cm (4.25 inches) from any wireway or other obstruction *on the wiring side of the Bus Interface Unit*. Allow more space if the wiring for I/O modules is very stiff.

Drill mounting holes for the BIU Terminal Block as shown below. Allow a small tolerance between the top and bottom of adjacent terminal blocks.



5. INSTALLING THE BUS INTERFACE UNIT TERMINAL BLOCK ON THE DIN RAIL

1. Tilt the Bus Interface Unit Terminal Block and position it over the rail, as shown below left, catching the rail behind the tabs in the terminal block.
2. Pivot the terminal block downward until the spring-loaded DIN rail latches in the terminal block click into place.

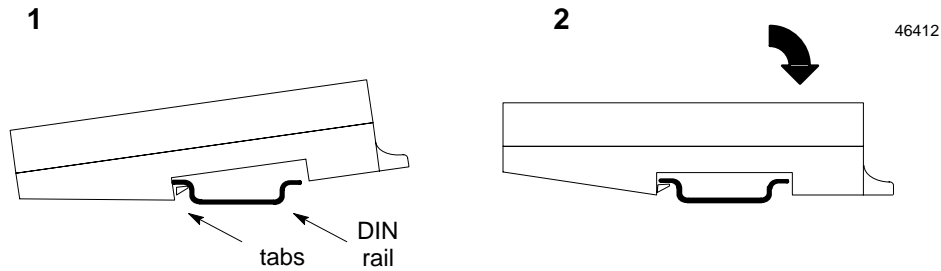

3. Tighten the DIN rail clamp screw (see below). Maximum recommended torque is 0.90 Nm to 1.13 Nm (8 in/lbs to 10 in/lbs).



4. Secure the terminal block to the panel with 9.525 mm (3/8 inch) No.6 screws (not supplied) through the mounting ears.

6. INSTALLING THE CABLES BETWEEN TERMINAL BLOCKS

Before installing modules on their terminal blocks, install the connecting cable(s) between terminal blocks. A short connecting cable, as illustrated below, is supplied with each I/O Terminal Block. A set of three connecting cables is available as renewal part number IC670CBL001. Optional 0.53 meter (21 inch) cable is also available (only one longer cable can be used per I/O station).

The illustration below shows cable connection between a Bus Interface Unit terminal block and an I/O Terminal Block. Make connections between I/O Terminal Blocks in the same manner. The connectors are keyed to assure proper installation.

After installing the cable, be sure it is firmly seated on both connectors.



7. SETTING THE BIU DIP SWITCHES

The DIP switches on the Bus Interface Unit select FIP or World FIP protocol and establish the BIU's Station ID (network address).

There are two DIP switch packs located inside the main portion of the BIU.



Switch Positions

Switch positions are numbered 0 through 7 *on the circuit board*.

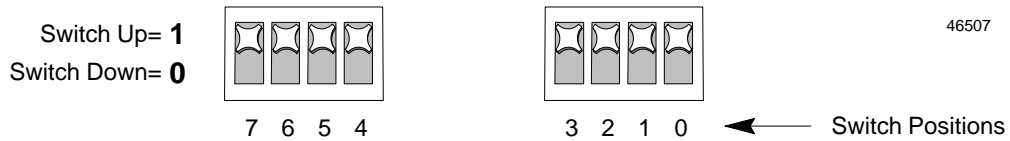

Switch 7 selects FIP or World FIP protocol, as shown in the table below. Switches 0 through 6 represent a Station ID from 0 to 127 (decimal).

Switch 7	Switches 6 to 0							Address Represented
7	6	5	4	3	2	1	0	
↑ FIP = 1 ↓ World FIP = 0	↓	↓	↓	↓	↓	↓	↓	∅
	↓	↓	↓	↓	↓	↓	↑	1
	·	·	·	·	·	·	·	·
	·	·	·	·	·	·	·	·
	·	·	·	·	·	·	·	·
	·	·	·	·	·	·	·	·
	·	·	·	·	·	·	·	·
	↑	↑	↑	↑	↑	↑	↑	127

8. INSTALLING THE BUS INTERFACE UNIT ON THE TERMINAL BLOCK

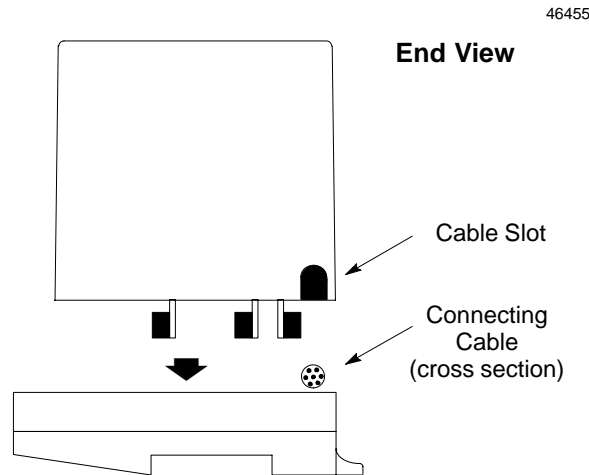

1. Before installing a new Bus Interface Unit, remove the cable slot knockout on the end of the module that will cover the connecting cable. It can be removed with pliers, or by pressing *out* from inside the module housing.
2. To install Bus Interface Unit on the terminal block, position the module so that the cable slot in the module housing is over the connecting cable. Press the module down firmly.

Caution

Do not exert excessive force; it may damage the equipment.

3. If unusual resistance is met, remove the Bus Interface Unit. If power is applied, **DO NOT TOUCH THE CONNECTOR PINS!** Inspect the Terminal Block, and the connectors on the Terminal Block and on the Bus Interface Unit. Remove any obstacles and reinsert the Bus Interface Unit.
4. After placing the Bus Interface Unit onto the terminal block, tighten its screws to secure it. Maximum recommended torque is 1.20 Nm (9 in/lbs).

9. SYSTEM WIRING GUIDELINES

Four types of wiring may be encountered in a typical factory installation:

1. Power wiring – the plant power distribution, and high power loads such as high horsepower motors. These circuits may be rated from tens to thousands of kVA at 220 VAC or higher.
2. Control wiring – usually either low voltage DC or 120 VAC of limited energy rating. Examples are wiring to start/stop switches, contactor coils, and machine limit switches. This is generally the interface level of the CE80–15 discrete I/O.
3. Analog wiring – transducer outputs and analog control voltages. This is the interface level to CE80–15 I/O analog blocks.
4. Communications and signal wiring – the communications network that ties everything together, including computer LANs, MAP, and FIP and N80 busses.

These four types of wiring should be separated as much as possible to reduce the hazards from insulation failure, miswiring, and interaction (noise) between signals. A typical PLC system may require some mixing of the latter three types of wiring, particularly in cramped areas inside motor control centers and on control panels.

In general, it is acceptable to mix the communications bus cable with the I/O wiring from the blocks, as well as associated control level wiring. All noise pickup is cumulative, depending on both the spacing between wires, and the distance span they run together. I/O wires and communications bus cable can be placed randomly in a wiring trough for lengths of up to 15 meters (50 feet). If wiring is cord-tied (harnessed), do not include the bus cable in the harness, since binding wires tightly together increases the coupling and mechanical stress that can damage the relatively soft insulation of some serial cable types.

Wiring which is external to equipment, and in cable trays, should be separated following NEC practices.

Installing Additional Suppression

It is possible some installations might exceed the surge immunity capabilities of the Bus Interface Unit. This is most likely in outdoor installations or where the power source is from another building or ground system. It is prudent to provide local transient protection.

10. SYSTEM GROUNDING

All components of a control system and the devices it controls must be properly grounded. Ground conductors should be connected in a star fashion, with all branches routed to a central earth ground point as shown below. This ensures that no ground conductor carries current from any other branch.



Each Alspa CE80–20 Terminal Block has a chassis ground terminal for safety and noise protection. This terminal should be connected to the conductive mounting panel with a 10 cm (4-inch) maximum length of 2.1 mm² (AWG No.14) wire. Use hardware such as star washers to ensure ground integrity.

The control panel and enclosure should also be bonded to the plant system ground per code. Inadequate grounding may compromise system integrity in the presence of power switching transients and surges.

11. POWER WIRING TO THE BUS INTERFACE UNIT

1. Connect an appropriate source of 24 VDC (nominal) to the Bus Interface Unit Terminal Block as shown below.
Do not apply power yet.



2. Connect the ground terminal to chassis ground using a 2.1 mm² (AWG No.14) stranded wire.

12. CONNECTING THE COMMUNICATIONS BUS

For information about cable type, termination, grounding, and connections between devices, please refer to the *ALS 52310 FIP Bus Controller (FBC) for Alspa C80–75 PLC User’s Manual*.

Attach FIP bus cable(s) to the connectors on the front of the Bus Interface Unit. When installed in a single media or simplex configuration, either connector may be used.

46508

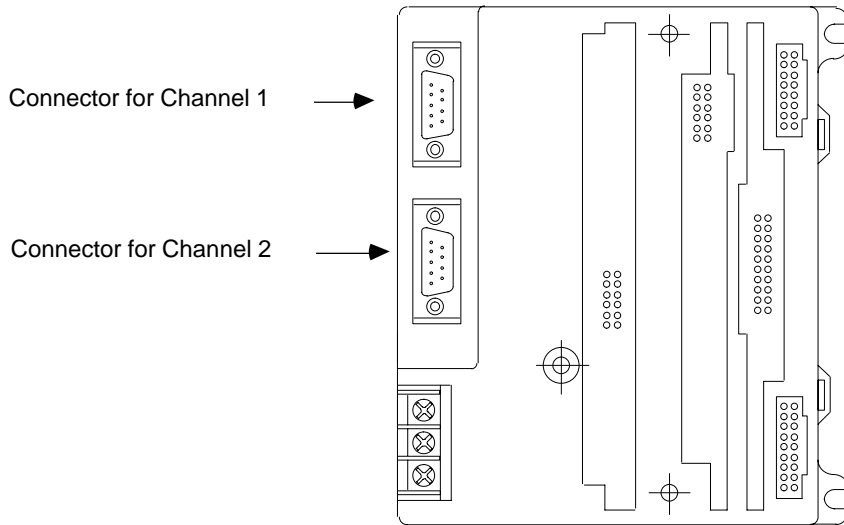

Note: If only one FIP bus is used, it is recommended that you cover the unused FIP bus connector with an anti-static cap.

Pin Assignments for the FIP Bus Connectors

The diagram below shows pin assignments for both FIP bus connectors on the front of the BIU.



13. OBSERVING THE LEDS

When power is applied, the LEDs on the BIU indicate operating and communications status.

46510



The top 2 LEDs indicate module health. The bottom 4 LEDs indicate communications activity on the FIP bus. Two LEDs are dedicated to each of the two FIP channels.

- MODULE OK** – Shows the status of the BIU. This LED blinks during power-up diagnostics and should remain on as long as power is applied to the BIU.
- RUN** – Shows whether the BIU is actively receiving outputs from the network.
- CARRIER DETECT** – A Carrier Detect LED is ON when the BIU is detecting a carrier signal on the FIP bus attached to that channel.
- TRANSMIT ENABLE** – A Transmit Enable LED is ON when the BIU transmits data on the FIP bus attached to that channel.

14. REMOVING/REPLACING THE BUS INTERFACE UNIT FUSE

If all the Bus Interface Unit LEDs go off, it may be necessary to replace its fuse. The fuse can be removed without disturbing any other parts of the station or wiring.

To check the fuse, remove power from the station.

Fully loosen the retaining screws in the Bus Interface Unit and carefully remove it from the Terminal Block. Do not tilt the module during removal.

Caution

Avoid touching the exposed wiring on the Terminal Block when removing the Bus Interface Unit.

Caution

Electrostatic discharge can damage the module when it is not installed on a Terminal Block. Always observe normal ESD protection practices (for example, use a grounding strap) when handling an un-installed module.

The fuse location is shown below. Visually inspect the fuse to see whether it has blown.



To remove the fuse from the holder, carefully pry it upward. Take care not to damage any components in the module. Place the new fuse in position and press it into the holder.

The fuse should be a 1A, 5x20 mm 250 VAC slow-blow type.

Reinstall the Bus Interface Unit on the BIU Terminal Block.

15. REMOVING THE BUS INTERFACE UNIT TERMINAL BLOCK FROM THE DIN RAIL

1. Loosen the clamp screw.
2. Remove the panel-mounting screws.
3. Insert a small flat-blade screwdriver into the upper latch and pry it outward. Then, pull up gently on the top of the terminal block to disengage the upper latch from the rail.



4. Keep gently pulling the top of the terminal block away from the rail. Insert the screwdriver into the lower latch and pry it outward to free the terminal block.

Chapter *Operation*

3

This chapter explains how a Bus Interface Unit interacts with the modules in its I/O Station, how it stores data, and how it exchanges data with the system host.

1. OPERATION

The primary runtime operations of the Bus Interface Unit are to accept data from the FIP bus and pass this to the corresponding output modules and to acquire updated input data for transmission onto the FIP bus.

If a problem occurs (or is corrected) with any module or circuit, it is included in the status information regularly transmitted by the Bus Interface Unit. Such module problems do not affect operation of the Bus Interface Unit or its communications on the network.

2. OPERATING MODES OF THE BUS INTERFACE UNIT



The Bus Interface Unit can operate in the following modes:

- Idle Mode
- Ready Mode
- Run Mode

How Communications Affect Operating Mode

The operating mode of the Bus Interface Unit depends on whether or not it is communicating with the FIP network.

- If it is communicating with the FIP network, the Bus Interface Unit may be commanded by the network controller to operate in Idle, Ready or Run mode.
- If a FIP network is not present, the Bus Interface Unit remains in Idle mode at powerup.
- If a FIP network is present but communications between the Bus Interface Unit and the network controller have been lost, the Bus Interface Unit returns from Run mode back to Ready mode.

3. IDLE MODE

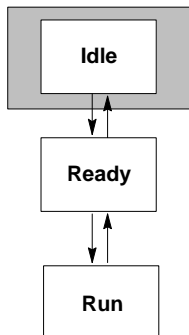

In Idle Mode, the Bus Interface Unit can indicate its presence on the FIP bus, but it cannot exchange I/O data.

The Bus Interface Unit is in Idle Mode after it is powered up but when no configuration or mode change commands have been received from the network. During normal operation, the Bus Interface Unit is only in Idle mode during the first few seconds after powerup. If a FIP network controller is not present, the Bus Interface Unit remains in Idle mode.

In Idle mode:

- the Bus Interface Unit scans I/O modules for identification information, input data and output data.
 With a **CE80–20 release 1**, outputs remain at their programmed default states or hold their last states as configured, unless forced. Any previously forced data is applied at powerup or if the equipment was previously in Ready Mode.
 With a **later release of the CE80–20**, outputs remain *off* or set to 0. However, I/O data may be temporarily forced using the HHP in order for a local user to verify the wiring. Any forced data is therefore lost if the equipment is power-cycled or goes to Ready Mode. If the equipment comes from Ready Mode, force conditions are not applied even though they have been stored in FLASH memory,
- all I/O validator data is set to “invalid,”
- a Hand–Held Programmer can be used to monitor I/O and input module configurations if no configuration is available from the network,
- The Bus Interface Unit can receive a system configuration from the FIP network. No forcing via FIP messages is permitted.

After receiving a system-level configuration the Bus Interface Unit can be commanded (from the network) to go to Ready mode.

4. READY MODE

The Bus Interface Unit goes to Ready mode when a system-level configuration has been received and enabled.



In Ready mode:

- the Bus Interface Unit waits for permission to enter Run mode from the FIP network controller,
- a Hand-Held Programmer can be used to monitor I/O and module configurations, and to force I/O data,
- configuration can NOT be changed by a Hand-Held Programmer,
- the Bus Interface Unit scans I/O in accordance with the configuration it received from the FIP network. If it was previously in Idle Mode, forced conditions previously stored in FLASH memory are restored and applied.

Input data is representative of the values scanned from the I/O modules except if they have been defaulted or forced.

Outputs are *off* or set to 0 if the FIP BIU was previously in Idle Mode or in a Run Mode before receiving a *Stop Cmd* message from the network.

Outputs are frozen if the FIP BIU was previously in a Run Mode and output data has never been received from the network.

Outputs are defaulted according to the configuration (default values or frozen) if the output data has been received at least once when in a Run Mode, before a network loss occurred,

- the Bus Interface Unit accepts forcing information from the network.

The Bus Interface Unit can be commanded (from the network) to go to Idle mode for reconfiguration or it may be commanded to go to Run mode.

5. RUN MODE

In Ready mode, when the Bus Interface Unit receives a command to do so, it goes to Run mode.



In Run Locked Mode:

- all configured modules are operational,
- data is communicated to and from the FIP network,
- the Bus Interface Unit scans I/O in accordance with the configuration it received from the FIP network,
- the Bus Interface Unit generates and observes validators,
- the Bus Interface Unit can communicate fully on the FIP network,
- configuration changes are not permitted,
- HHP use is not permitted in Run Locked Mode.

The mode changes back to Ready upon command from the network or if the Bus Interface Unit loses communications.

Run Unlocked Mode

Run Unlocked mode is the same as described above, except that the Bus Interface Unit does not check refreshment and promptness status in Run Unlocked mode.

HHP is usable in Run Unlocked Mode as it was in Ready Mode.

6. I/O DATA

The Bus Interface Unit stores I/O data, as well as additional data representing forced conditions and “validator” status, in separate memory areas.

Data Description	Data Type Displayed on HHP	Alspla C80–75 PLC Data Type
discrete input states	I	%I
discrete output states	Q	%Q
analog input values	AI	%AI
analog output values	AQ	%AQ
discrete input validators		Fault/No Fault Contacts
output validators		
analog input validators		
analog output validators		

In the Bus Interface Unit, the I/O state and validator tables contain the input and output data.

- If the Bus Interface Unit detects a problem while reading a module’s inputs, it sets to “invalid” all Input Validators for that module.
- If output validators for outputs received from the network are “invalid”, those outputs will be defaulted or hold last state.

Displaying Data with a Hand–Held Programmer

The Hand–Held Programmer can read data directly from the Bus Interface Unit. If the Bus Interface Unit is in Idle, Ready mode or Run Unlocked mode, the Hand–Held Programmer can also force the states of I/O data.

6.1. Discrete Inputs

The Bus Interface Unit has the following discrete input tables:

I	discrete input states
IV	discrete input validators
IF	force applied: discrete inputs
IFV	force applied: discrete input validators

The Bus Interface Unit processes input data as described below.

1. The Bus Interface Unit scans input modules in the I/O Nest and then places discrete input data in its discrete input table.

Example:

The Bus Interface Unit reads the inputs configured to use I0001 to I0008 during its input scan. It places the data into its discrete input table:

I0001		I0008					
1	0	0	1	0	1	0	0

2. If the Bus Interface Unit detects a module fault while reading the input data, it defaults all inputs for that module to the configured off or last state, and marks them as “invalid” by setting the input validator (IV) locations associated with those inputs.

Example:

If the module supplying inputs I0001 to I0008 is configured to default inputs OFF, and the module is subsequently removed, the Bus Interface Unit sets its inputs OFF and also sets the corresponding input validator data:

I0001		I0008						
0	0	0	0	0	0	0	0	Inputs set to OFF
IV0001		IV0008						Input validators set to “invalid”
1	1	1	1	1	1	1	1	

3. If the Bus Interface Unit is in any Idle or Ready mode, inputs may be forced. The Bus Interface Unit sets the corresponding inputs in the input table. When a force is removed, the input table displays the normal data following the next I/O scan.

Example:

The HHP is used to force input I0008 to 1.



4. When you force the state of a point, the Bus Interface Unit forces the corresponding validator (IVF) to 0 (valid).

Input Data Sent on the Bus

The Bus Interface Unit treats the data acquired from each Input or Input/Output module as an “application variable.” It combines these (input) application variables into one or more Communications Variables (COMVs). It periodically transmits these COMVs on the FIP Network.



The Bus Interface Unit honors requests for input data even when the data is invalid (e.g. the corresponding input module has been removed). By monitoring the validity data, the host can know whether the data it receives from the Bus Interface Unit is real or defaulted input data.

6.2. Discrete Outputs

The Bus Interface Unit has the following discrete output tables:

Q	discrete output states
QV	discrete output validators
QF	force applied: discrete outputs
QVF	force applied: discrete output validators

The Bus Interface Unit processes output data as described below.

1. The Bus Interface Unit periodically receives Communications Variables (COMVs) containing discrete output data. The content of these COMVs may depend on the system host. In an Alspa 8000 PLC system, discrete output COMVs consist of Q data (application variables) and QV data (validity qualifiers).



2. The Bus Interface Unit places the output data into its discrete output table.

Example:

The Bus Interface Unit receives output data from the host, including outputs Q0009 to Q0016. It places those outputs into its discrete output table as illustrated below:

Q0009		Q0016					
0	0	1	1	0	1	1	1

3. The Bus Interface Unit checks the corresponding validity data to determine whether or not the output data received from the host is valid.

The specific way output validators are set may depend on the system host. In an Alspa C80-75 PLC system, the PLC bus controller sets the output validators to invalid if it doesn't receive output communications from the CPU. The Bus Interface Unit also sets output validators if it doesn't receive output data from the FIP bus during a specified period of time.

If an output validator is set to invalid, the Bus Interface Unit discards the actual output data and sets the corresponding output to the configured default states or holds their last state (as configured).

Example:

If the host stopped sending outputs, the Bus Interface Unit could set all discrete outputs to off (as shown here) or to their last state, and also set the corresponding output validator data:

Q0009	Q0016	
0	0	0
0	0	0
0	0	0
0	0	0
0	0	0
0	0	0
0	0	0
Outputs set to OFF		
QV0009	QV0016	
1	1	1
1	1	1
1	1	1
1	1	1
1	1	1
1	1	1
1	1	1
Output validators set to "invalid"		

4. The Bus Interface Unit passes outputs (either actual outputs or outputs that are defaulted) to the output modules. The output scan occurs after the input scan.
5. If the Bus Interface Unit is in any Idle or Ready mode, outputs may be forced from the HHP. The Bus Interface Unit sets the corresponding outputs in the output force (QF) table. The forced state becomes the state of the output circuit.

Example:

The HHP is used to force output Q0012 to 0.

Q0009	Q0016	
0	0	1
0	1	1
1	0	1
1	1	1
1	1	1
1	1	1
1	1	1
Output Data before forcing		
1	1	1
1	0	0
1	0	1
0	0	1
0	1	0
1	0	1
Output Data after forcing		

When a force is removed, the data in the corresponding I/O table displays the normal data following the next I/O scan. Outputs retain an up-to-date processed value, which is used whenever the forced value is removed.

6.3. Analog Inputs

The Bus Interface Unit has the following analog input tables.

AI	analog input values
AIV	analog input validators
AIF	force applied: analog inputs
AIVF	force applied: analog input validators

The Bus Interface Unit processes analog input data as described below (analog input modules filter data locally, so the data is already filtered when the Bus Interface Unit reads it.)

1. The Bus Interface Unit scans analog input modules in the I/O Nest and places analog input data in its analog input table.

Example:

During the analog input scan, the Bus Interface Unit reads the inputs configured to use AI001 through AI004. It places the inputs into its analog input table:

AI001	57143
AI002	16385
AI003	36884
AI004	1141

2. If the Bus Interface Unit detects a module fault while reading the input data, it defaults all inputs associated with that module to their default/hold last state values, and marks them as “invalid” by setting to 8Xh the AIV locations associated with those inputs (80h: invalid, X: specific fault involving the invalidity).

Example:

If the module supplying inputs AI001 to AI004 were removed and the module were configured for Hold Last State, the Bus Interface Unit would hold the inputs for that module to their last values, and set the corresponding validators to invalid (8Xh).

Analog Input Data		Validator Status		
AI001	57143	AIV001	80h	8Xh = invalid
AI002	16385	AIV002	80h	
AI003	36884	AIV003	80h	
AI004	1141	AIV004	80h	

3. Analog inputs may be forced. The Bus Interface Unit sets the corresponding inputs in the analog input table, which also contains the current states of unforced inputs. When a force is removed, the input table displays the normal data following the next I/O scan.

Example:

The HHP is used to force analog input AI002 to a different value. The forced value replaces the actual value in the analog input table:

	Analog Input Data before forcing	Analog Input Data after forcing
AI001	57143	57143
AI002	16385	500
AI003	36884	36884
AI004	1141	1141

- When you force the value of a channel, the Bus Interface Unit also forces the corresponding validator (AIVF) to 0.

Example:

When the HHP forces input AI002 its input validator is also forced.

	Analog Input Data before forcing	Validator Status	Analog Input Data after forcing	Validator Status after forcing
AI001	57143	80h	57143	80h
AI002	16385	84h	500	0
AI003	36884	82h	36884	82h
AI004	1141	81h	1141	81h

Analog Input Data Sent on the Bus

The Bus Interface Unit combines analog input data into one or more Communications Variables (COMVs). It periodically transmits these COMVs on the Network.



The Bus Interface Unit honors requests for input data even when the data is invalid (e.g. the corresponding input module has been removed). By monitoring the validity data, the host can know whether the data it receives from the Bus Interface Unit is real or defaulted input data.

6.4. Analog Outputs

The Bus Interface Unit has the following analog output tables.

AQ	analog output values
AQV	analog output validators
AQF	force applied: analog outputs
AQVF	force applied: analog output validators

The Bus Interface Unit processes analog output data as described below.

1. The Bus Interface Unit periodically receives Communications Variables (COMVs) containing analog output data.

The content of these COMVs may depend on the system host. In an Alspa 8000 PLC system, analog output COMVs consist of AQ data (application variables) and AQV data (validity qualifiers).



2. The Bus Interface Unit places the output data into its Analog Output table.

Example:

The Bus Interface Unit receives output data from the host, including outputs AQ005 through AQ008. It places those outputs into its AQ data table as illustrated below:

AQ005	114
AQ006	72
AQ007	106
AQ008	93

3. The Bus Interface Unit checks the corresponding validity data to determine whether or not the output data received from the host is valid.

The specific way output validators are set may depend on the system host. In an Alspa C80-75 PLC system, for example, the PLC bus controller sets the output validators to invalid if it doesn't receive output communications from the CPU. The Bus Interface Unit also sets output validators if it doesn't receive output data from the FIP bus during a specified period of time.

- 4. If output validators are set to invalid the Bus Interface Unit defaults the output data to a configured value or holds its last state, as configured.

Example:

If the host stopped sending outputs, the Bus Interface Unit would default or hold all analog outputs at their last values and also set the corresponding output validator data:

Analog Output Data		Validator Status	
AQ005	114	AQV005	80h
AQ006	72	AQV006	80h
AQ007	106	AQV007	80h
AQ008	93	AQV008	80h

80h = invalid

7. DIAGNOSTICS

The Bus Interface Unit provides status information for each I/O module in the I/O Nest. If a fault occurs, the fault is logged and the corresponding fault contact is activated. It remains activated only while the fault is in effect. After the condition that caused the fault is corrected, the Bus Interface Unit deactivates the corresponding fault contact and resumes normal operation of the affected circuit(s).

7.1. Status Data Transmitted by the Bus Interface Unit

The Bus Interface Unit periodically transmits status information as a separate Communications Variable.



If a problem occurs (or is corrected) with any module or circuit, it is included in this status information. Such module problems do not affect the operation of the Bus Interface Unit or its communications on the network.

7.2. I/O module validators

The FIP Bus Interface Unit handles the processing of the I/O modules validators. Validators are set :

- when a slot is configured for a specific module but no module is present,
- when the module present does not match the one defined in the configuration,
- when the module is faulted,
- when the module or the FIP BIU reports a user fault for that slot.

Dumb and smart I/O modules provide diagnostic data to the FIP BIU.

The validators always have the same format which is one bit per point for discrete I/O and one byte per channel for analog and smart modules.

7.2.1. Discrete and analog modules



In the special case of the 8 analog input module, additional data may be reported in the validator to show specific user faults or alarms:

- b0 : Low alarm *
- b1: High alarm *
- b2 : Under-range,
- b3 : Over-range,
- b4 : Open-wire.

* : with alarm bits, the validity bit (b7) is not affected.

7.2.2. Smart modules



Smart I/O modules may report extra diagnostic data. The FIP BIU may be configured to decode this module's data to set up specific bits in the module's validators.

The Network configuration provides the following parameters :

- the number of user faults to report (corresponding to one bit of the validator),
- the validator bit rank, which is the position of the bit to set/clear in the validator,
- the fault bit value which indicates if the validator bit has to be set or cleared,
- and for each channel :
 - the byte offset within the diagnostic bytes returned by the I/O module,
 - the bit position of the fault in the byte previously selected.

The Network Configuration provides also parameters meant to report Alarm bits in the validators. In that case the validity bit (b7) is not affected.

=> Refer to *ALS 52308 CE80-20 I/O Modules User's Manual* for explanations regarding the diagnostic bits reported by the smart modules.

7.2.3. Bus Interface Unit Status Data Format

The format of the status (IOSTAT) COMV sent by the Bus Interface Unit is shown below.

Offset (Byte No.)	Content		Description
0 1	2 (constant) 0 (constant)		FIP Bus Interface Unit Identification
2, 3	0 to 65535		Network configuration Version number
4	00 = Non-operational fault 01 = Operational: Idle 02 = Operational: Ready 03 = Operational: Running Locked 04 = Operational: Running Unlocked		Current Operating mode of the FIP BIU. This field is updated as long as the FIP BIU is Operational.
5	Bit	Status Bits	
	0	Loss of FIP Status bits	Set when status bits (refreshment and promptness) associated with any consumed COMVs are invalid. Cleared when all status bits are valid.
	1	Slow scanning mode	Set when BIU is in slow scanning mode because at least one analog I/O module has been scheduled to have its inputs or outputs scanned over several cycles.
	2	I/O are currently forced	Set when any points are forced whatever using the HHP or a network message.
	3 – 6	reserved	
	7	Ready mode disconnected	Set if the I/O nest is in READY mode following on a network fault or disconnection. Cleared as soon as a command is received regardless of whether or not the command is valid. Loss of more than three consecutive EOC in synchronous mode or failure to consume at least one COMV are treated as network failures.
6	Bit	Fault Type	
	0	Blocking (fatal) fault	Always 0.
	1	Non-blocking fault	Set when any Scanner or I/O faults are detected. Cleared otherwise.
	2	Scanner blocking fault	Always 0.
	3	Scanner non-blocking fault	Set when the <i>Scanning Module Fault</i> (byte 8) is not 0.
	4	I/O module fault	Set when any I/O modules have the status: empty, discordant, user-fault or fault.
	5–7	reserved	
7		0	Unused.

Offset (Byte No.)	Content		Description
8	Bits	Scanning module faults	
	0,1	reserved	
	2	Store operation failure	Set when an error occurs during a non-volatile memory store operation. Cleared by a successful store operation.
	3	Watchdog expired *	Set when a watchdog fault occurs after a transition to Idle mode. Cleared when a CONFIG_ENABLE command is received. This bit remains set until the next time the FIP BIU is commanded to go to Ready or Run mode.
	4	Timing Fault	Set when an RTC interrupt has taken more than 10 ms to execute. Once it is set, it stays set until a new valid command is received.
	5	reserved	
	6	Loss of FIP media redundancy	Set when a redundancy error has been detected. Cleared when the redundancy is restored.
	7	reserved	
9		8 (constant)	Number of I/O slots.
10, ...,18		I/O Slot status (<i>repeated for each I/O module</i>). May have the following values for a FIP BIU application:	
		01 = empty	The configuration is installed, but there is nothing present in the slot even though that slot has been configured.
		02 = discordant	The configuration is installed, but the module in the slot does not match the configuration.
		04 = operational	Configuration installed, correct module is present in slot and it is fully functional.
		05 = user fault	The configuration is installed, module is operational but the module reports a user fault.
		ff = fault (255 decimal)	Configuration is installed, correct module is present in slot, but it is not operating.

* If the watchdog timer expires, the Bus Interface Unit goes to Idle mode and sets the Watchdog Expired bit in <Scanning Module Fault>. This bit remains set until the next time the FIP Bus Interface Unit is commanded to go to Ready or Run mode.

This chapter explains how to use a Hand–Held Programmer with a FIP Bus Interface Unit:

- Using the Hand–Held Programmer,
 - HHP Displays,
 - Menu Overview,
 - Moving from Screen to Screen,
- Displaying and Editing Configuration Data,
 - Displaying the Bus Interface Unit Configuration,
 - Configuring I/O Modules,
 - Reading a Module Configuration,
 - Configuring an Empty Slot,
 - Configuring a Discrete Input Module,
 - Configuring a Discrete Output Module,
 - Configuring an Analog Input Module,
 - Configuring an Analog Output Module,
- Monitoring and Forcing I/O Data,
 - Looking at I/O Data,
 - Changing the Data Display Format: Binary, Hex, Decimal,
 - Forcing and Unforcing Data,
- Displaying and Clearing Faults,
 - Displaying Faults,
 - Clearing Faults.

For Additional Information, Also See:

For additional information on basic Hand–Held Programmer functions, please refer to the *ALS 52202 Hand–Held Programmer for Alspa C80–35, C80–25 and C80–05 PLCs User’s Manual*.

1. USING THE HAND-HELD PROGRAMMER

Attach the Hand-Held Programmer to the MONITOR connector on the BIU.



1.1. HHP Displays

The content of the HHP display screens varies according to the type of device it is connected to (for example, the screens for a FIP BIU are different from the screens for a Remote I/O Scanner).

This is the HHP's main menu when it is connected to a FIP Bus Interface Unit:

```
1 Monitor I/O
2 Configuration
```

1.2. Menu Overview

The illustration below shows the primary Hand-Held Programmer menus that are accessed from the FIP BIU main menu.



Moving from Screen to Screen

To move between displays, use the following keys:

- ➡ press the Right Arrow key to go “down.”
- ⬅ press the Left Arrow key to go “up.”
- ⬆ press the Up Arrow key to go up one branch.

Advancing past the last screen in a set returns you to the top.

2. DISPLAYING AND EDITING CONFIGURATION DATA

From the main menu, press the **2** key (Configuration). This menu appears:

<p>1 FIP Config 2 Module Config</p>

From this menu, you can:

- Press the **1** key to display, but not change, the FIP Bus Interface Unit configuration.
- Press the **2** key to enter, display, and edit I/O module configurations.

3. DISPLAYING THE BUS INTERFACE UNIT CONFIGURATION

When you press the number **1** key from the Configuration menu, the first BIU configuration display screen appears.

The first screen shows the FIP Station ID (14 in this example).

FIP ID 14

Press the RIGHT ARROW key to display other Remote I/O Scanner parameters. Parameters appear in this order:

DISPLAY	VALUES	DESCRIPTION
FIP ID :	0, ..., 127	Current Remote I/O Scanner FIP subscriber number. Selected by built-in dipswitch.
FIP Protocol :	FIP or WORLD FIP	Current FIP network protocol selected by built-in dipswitch.
FIP Transf rate : **	1 MHz or 2.5 MHz	FIP data transfert rate. Depends on board used.
FIP Time Slot : **	250 or 200	FIP network Time Slot. Depends on board used and data transfert rate.
Config Version : *	0000, ..., FFFFh	Version number of the current configuration installed. A null value means no configuration installed or invalid configuration.
Config Error : *	0000, ..., 60000	Error code corresponding to a list of identified errors listed in a specific release document.
Firmware Rev : *	2.00 < vv < x.yz	Remote I/O Scanner firmware revision number.
FIP FDM Lib Rev : *	4.3 < w.w < a.b	FIP Device Manager library revision number.
Board Number : *	FBI001 or FBI002	Remote I/O Scanner board revision number (1 MHz or 2.5MHz board).

4. CONFIGURING I/O MODULES

When you press the **2** key from the Configuration menu, the first module configuration screen appears.

At first, the module configuration screen looks like this:

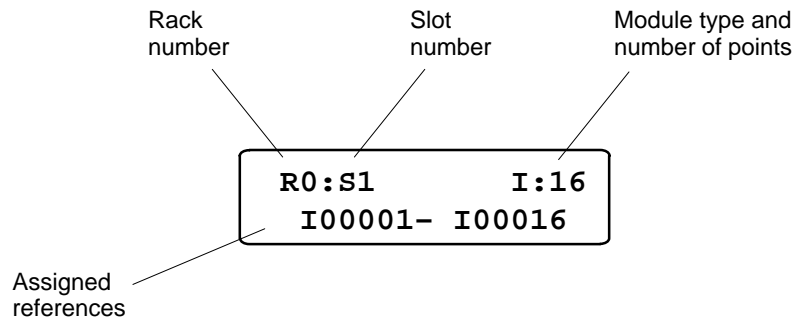

The **Rack Number** is always 0.

The **Slot Number** refers to the location of the module in the station, relative to the Bus Interface Unit. See the illustration below.

From this screen, you can:

- Display other modules using the Right Arrow and Left Arrow key.
- Delete the currently-displayed module by pressing the **DEL** key.
- Configure the currently-displayed module by pressing the **ENT** key.

To edit the module's configuration, press F4 (zoom). Refer to the module configuration instructions on the following pages for more information.

4.1. Reading a Module Configuration

If there is an unconfigured module present in the slot, press the **READ** key to read its configuration. You can edit this configuration as described on the following pages.

4.2. Configuring an Empty Slot

If there is no module present in the slot, the screen displays:

```
R0:S1      EMPTY
```

If you want to enter a configuration, press the **INS** key. This screen will appear:

```
R0:S1 I/O Type ?
Generic I/O
```

1. Press the **+/-** key to select either Generic I/O, Special I/O or Smart I/O (see the list below). Then press the **ENT** key..

```
R0:S1 I/O Type ?
Special I/O
```

```
R0:S1 I/O Type ?
Smart I/O
```

2. The screen prompts: **R0:S1 Mod Type ?** Use the **+/-** key to go through the module names listed below.

Generic I/O	Modules
Discrete Input 8	IC670 MDL233
Discrete Input 16	IC670 MDL240 MDL241 MDL640 MDL641 MDL642 MDL643 MDL644
Discrete Output 8	IC670 MDL331 MDL730 MDL930
Discrete Output 16	IC670 MDL330 MDL740 MDL742
Special I/O	Modules
Analog 8 Current Input	IC670 ALG230
Analog 4 Current Output	IC670 ALG320
Smart I/O	Modules
Analog 16 Current Input	IC670 ALG240
Analog 4 RTD Input	IC670 ALG620
Analog 8 THM Input	IC670 ALG630
Analog 8 Current Output	IC670 ALG330

- When the correct module name appears, press the **ENT** key. Complete the module configuration as described on the following pages.
 - to configure a Discrete Input Module, see page 4–8, § 4.3.
 - to configure a Discrete Output Module, see page 4–10, § 4.4.
 - to configure an Analog Input Module, see page 4–11, § 4.5.
 - to configure an Analog Output Module, see page 4–15, § 4.6.

4.3. Configuring a Discrete Input Module

A discrete input module has two configurable parameters:

- Fault Reporting
- Selection of either Hold Last State or Default to Zero for all the module’s inputs.

4.3.1. Report Faults

If you press the **ENT** key from a discrete module screen, the following configuration screen appears:

<p>S1 Report Faults NO</p>
--

The first line shows the module's slot number (**(S)lot 1** above) and the first configuration parameter, Fault Reporting. This parameter determines whether or not the Bus Interface Unit will report faults from the module to the host.

1. Select **Y** if the Bus Interface Unit should report module faults to the host. Select **N** if it should not. Use the **+/-** key if you want to change the selection.
2. Use the **ENT** key to save the selection and go on to the next item.

4.3.2. Default Inputs or Hold Last State

If you press the **ENT** key from the Report Faults screen, the following configuration screen appears:.

```
S1 Hld Lst State
NO
```

This parameter determines what type of data the Bus Interface Unit should provide to the host if it stops receiving actual input data from the module.

1. Select **YES** if the Bus Interface Unit should hold inputs in their last states and supply that data to the host.
Select **NO** if the Bus Interface Unit should default all the module's inputs to 0 and supply that data to the host instead.
2. Use the **ENT** key to save the selection.

4.4. Configuring a Discrete Output Module

A discrete output module has three configurable parameters:

- Selection of either Hold Last State or Default for all the module's outputs.
- Selection of either 0 or 1 as the default state for each output (used only if Hold Last State is set to **NO**).
- Fault Reporting

4.4.1. Default Outputs or Hold Last State

The selection determines what type of data the Bus Interface Unit will provide to the module if it stops receiving actual output data from the host.

```
S2 Hld Lst State
NO
```

1. Use the **+/-** key if you want to change the selection.
Select **YES** if the Bus Interface Unit should hold outputs in their last states and supply that data to the module.
Select **NO** if the Bus Interface Unit should default all the module's outputs and supply that data to the module instead.
2. Use the **ENT** key to save the selection.
If Hold Last State is set to **NO**, the following screen appears:

S1 Out Def Pt 01 0010000010010101	Number of the point at the cursor location
--	---

3. On this screen, select a default state (1 or 0) for each output.
4. Use the **ENT** key to save the entries.

4.4.2. Report Faults

On the next screen, configure whether or not the Bus Interface Unit will report faults from this module to the host.

S2 Report Faults NO

1. If you want to change the current selection, press the +/- key.
2. Use the **ENT** key to save the selection and go on to the next item.

4.5. Configuring an Analog Input Module

An analog input module has these configurable parameters:

- Default inputs or hold inputs in their last values
- Fault Reporting
- Channel active
- Input current/voltage range
- Input scaling
- Alarm thresholds

4.5.1. Default Inputs or Hold Last Values

First, configure what type of data the Bus Interface Unit should provide to the host if it stops receiving actual input data from the module.

S3 Hld Lst State NO

1. Use the +/- key if you want to change the selection.
 Select **YES** if the Bus Interface Unit should hold inputs in their last states and supply that data to the host.
 Select **NO** if the Bus Interface Unit should default all the module's inputs to 0 and supply that data to the host instead.
2. Use the **ENT** key to save the entry and go on to the next configuration step.

4.5.2. Fault Reporting

The Bus Interface Unit can report faults for each channel to the host. If fault reporting is enabled for a channel, the Bus Interface Unit sends a message to the host CPU if any fault occurs on that channel. If fault reporting is disabled, the Bus Interface Unit does not send fault reports for the channel to the host CPU.

Regardless of whether fault *reporting* is enabled, the Bus Interface Unit detects faults on the circuit and takes appropriate action. If a fault occurs, the fault condition must be corrected for proper operation of the I/O module.



1. For each channel, select **Y** if the Bus Interface Unit should report module faults to the host for that channel. Select **N** if it should not. Use the **+/-** key if you want to change the selection.
2. Use the Left Arrow and Right Arrow keys to select channels.
3. Use the **ENT** key to save the selections on this screen and go on to the next item.

4.5.3. Channel Active

If a channel is not wired, or if a channel is wired but should not report diagnostics, that channel can be configured as inactive.



1. For each channel, select **Y** if the channel should be active. Select **N** if it should not.
2. Use the Left Arrow and Right Arrow keys to select channels.
3. Use the **ENT** key to save the selections on this screen and go on to the next item.

4.5.4. Input Current/Voltage Ranges

Select a voltage or current range for each channel to correspond to the signal level of the input device. Note that Current Source Analog Input Module (IC670ALG230) and Current Source Analog Output Module (IC670ALG320) can only be set for 0 to 20 mA or 4 to 20 mA.

- 0 to 20 mA
- 4 to 20 mA
- 0 to 10 volts DC
- 10 volts DC to +10 volts DC



1. For each channel, use the +/- key to select a range.
2. Repeat this step for each of the eight channels, using the Left Arrow and Right Arrow keys to select channels.
3. Use the **ENT** key to save the selections on this screen and go on to the next item.

Note

Range Selection is a setup parameter; it is not ordinarily changed while the module is operating.

4.5.5. Input Scaling

Based on the actual analog input signal level for a channel, the analog input module reports a value from decimal 0 to 4095 to the Bus Interface Unit. This value is then converted to internal units. The Bus Interface Unit can convert this internal value to a value that is more meaningful to the application by using the “scaling values” configured on this screen.

For each channel, two sets of values are configured: high and low internal values and the actual high and low engineering unit values they represent. Based on these two pairs of values, the Bus Interface Unit will be able to scale values for all other input levels.

See the *Bus Controller User’s Manual* for information on finding appropriate scaling values for your application. If you don’t have scaling values ready, you can continue to the next screen now, and configure scaling at another time. The Bus Interface Unit will use default scaling values of 1:1 if no scaling values are entered.



1. For EACH channel in turn, enter scaling values in this order:
 - Low scaling value (“eng lo”)
 - High scaling value (“eng hi”)
 - Low digital value (“int lo”)
 - High digital value (“int hi”)
2. If you press the Right Arrow key, the display goes from value to value in sequence. If you press the Left Arrow key, the display goes to the first value for the previous channel.
3. Use the HHP keypad to enter values. To enter a negative value, first enter the numbers, then press the - key.
4. Use the **ENT** key to save the selections on this screen and go to the next item.

4.5.6. Alarm Thresholds

Each input channel can have two Alarm Thresholds, one for a low engineering units (scaled) value and one for a high value.

Maximum values are $\pm 32\,767$. The high threshold should be greater than the low threshold. Threshold limits are based on circuit scaling. If scaling is changed, review and readjust the Alarm Thresholds if necessary.

Alarm Thresholds can be set anywhere over the dynamic range of the signal. Typically, they are set at levels beyond which the input should not operate or levels beyond which alternate processing is required. They can also be set beyond the dynamic range of the signal, ensuring that they will never be activated. See the examples below.

1. For EACH channel in turn, first, enter a low alarm value:

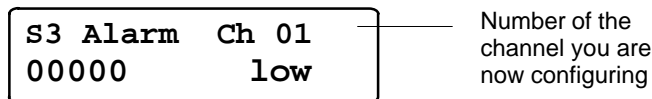

2. Press the **ENT** key.
3. Then enter a high alarm value:

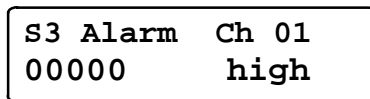

4. Use the Arrow keys to select channels.
5. Press the **ENT** key to save the selection. Press the Right Arrow key to return to the original slot configuration screen.

Example 1: A circuit is expected to report engineering unit values of -6 m/sec (-20 ft/sec) to $+55$ m/sec ($+180$ ft/sec). The high alarm is set at $+40$ m/sec (150 ft/sec) and the low alarm at -7.5 m/sec (-25 ft/sec).

If an input reached its high alarm, a new threshold could be set. This could generate a high-high alarm or an alarm-cleared threshold.

Example 2: An Alarm Threshold is set at $+40$ m/sec (150 ft/sec). Upon receiving an alarm message, the CPU changes the Alarm Threshold to $+50$ m/sec (165 ft/sec) by using a Write Configuration command and sends the appropriate Clear Circuit Fault command. No alarm message is sent upon changing the threshold unless the speed is greater than $+50$ m/sec (165 ft/sec). If the speed is only $+48$ m/sec (157 ft/sec) but increasing, a second message would be sent at $+50$ m/sec (165 ft/sec). Since these two diagnostic messages are the same, it would be necessary for the program to keep track of the level of the Alarm Thresholds and recognize this as a higher alarm than that received initially. At the same time, it could move the low alarm to $+42$ m/sec (140 ft/sec) and use this level to detect the end of the high alarm conditions.

4.6. Configuring an Analog Output Module

An analog output module has these configurable parameters:

- Default outputs or hold outputs in their last values
- Fault Reporting
- Channel active
- Output current/voltage range
- Output scaling

4.6.1. Default Outputs or Hold Last Values

First, configure what type of data the Bus Interface Unit should provide to the module if it stops receiving actual output data from the host.

```
S4 Hld Lst State
NO
```

1. Select **YES** if the Bus Interface Unit should hold outputs in their last states and supply that data to the module. Select **NO** if the Bus Interface Unit should default all the module's outputs and supply that data to the module instead.
2. Press **ENT** to save the selection.

4.6.2. Fault Reporting

The Bus Interface Unit can report faults for each channel to the host. If fault reporting is enabled for a channel, the Bus Interface Unit sends a message to the host CPU if any fault occurs on that channel. If fault reporting is disabled, the Bus Interface Unit does not send fault reports for the channel to the host CPU.

Regardless of whether fault *reporting* is enabled, the Bus Interface Unit detects faults on the circuit and takes appropriate action. If a fault occurs, the fault condition must be corrected for proper operation of the I/O module.

```

Selections for all 4 channels — S4 Faults Ch 01 — Number of the channel
                                NNYY — at the cursor location

```

1. Use the **+/-** key to select **Y** or **N** for each channel. Select **Y** if the Bus Interface Unit should report module faults to the host for that channel. Select **N** if it should not.
2. Use the Arrow keys to select channels. If Hold Last State is set to **NO**, pressing the Left Arrow key from the first channel displays the Output Default screen.

4.6.3. Channel Active

If a channel is not wired, or if a channel is wired but should not report diagnostics, that channel can be configured as inactive.



1. For each channel, select **Y** if the channel should be active. Select **N** if it should not.
2. Use the Left Arrow and Right Arrow keys to select channels.
3. Use the **ENT** key to save the selections on this screen and go on to the next item.

4.6.4. Output Current/Voltage Ranges

Select the voltage or current range for each channel to correspond to the signal level of the output device. Note that Current Source Analog Output Module (IC670ALG320) can only be set for 0 to 20 mA or 4 to 20 mA.

- 0 to 20 mA
- 4 to 20 mA
- 0 to 10 volts DC
- 10 volts DC to +10 volts DC



1. For each channel, use the +/- key to select a range.
2. Repeat this step for each of the eight channels, using the Left Arrow and Right Arrow keys to select channels.
3. Use the **ENT** key to save the selections on this screen and go on to the next item.

Note

Range Selection is a setup parameter; it is not ordinarily changed while the module is operating.

4.7. Output Scaling

While the actual values received from the application program may represent various types of engineering units, the Bus Interface Unit reports values from decimal 0 to 4095 to an analog output module. The BIU converts the application data into internal units using “scaling values”. These internal values are then converted to counts and sent to the output channels.

For each channel, two sets of values are configured: high and low internal values and the actual high and low engineering units values they represent. Based on these two pairs of values, the Bus Interface Unit will be able to scale values for all other output levels.

See the *ALS 52310 FIP Bus Controller (FBC) for Alspa C80–75 PLC User’s Manual* for information on finding appropriate scaling values for your application. If you don’t have scaling values ready, you can continue to the next screen now and configure scaling at another time. The Bus Interface Unit will use default scaling values of 1:1 if no scaling values are entered.



1. For EACH channel in turn, enter scaling values in this order:

Low scaling value (“eng lo”)
 High scaling value (“eng hi”)
 Low digital value (“int lo”)
 High digital value (“int hi”)

2. If you press the Right Arrow key, the display goes from value to value in sequence. If you press the Left Arrow key, the display goes to the first value for the previous channel.
3. Use the HHP keypad to enter values. To enter a negative value, first enter the numbers, then press the +/- key.
4. Use the **ENT** key to save the selections on this screen and go to the next item.

Note

Range Selection is a setup parameter; it is not ordinarily changed while the module is operating.

5. MONITORING AND FORCING I/O DATA

From the main menu, press the **1** key (Monitor I/O). This menu appears:



From this menu, you can:

- Press the **1** key to display and force I/O data.
- Press the **2** key to display fault information.

5.1. Looking at I/O Data

When you press **1** from the Monitor I/O menu, the HHP displays I/O data starting with the first configured discrete input (I) data. Press the Right Arrow key to display more data in this sequence:

- All discrete inputs (I)
- All discrete outputs (Q)
- All analog inputs (AI)
- All analog outputs (AQ)

The illustration below shows the format of the data display screens.

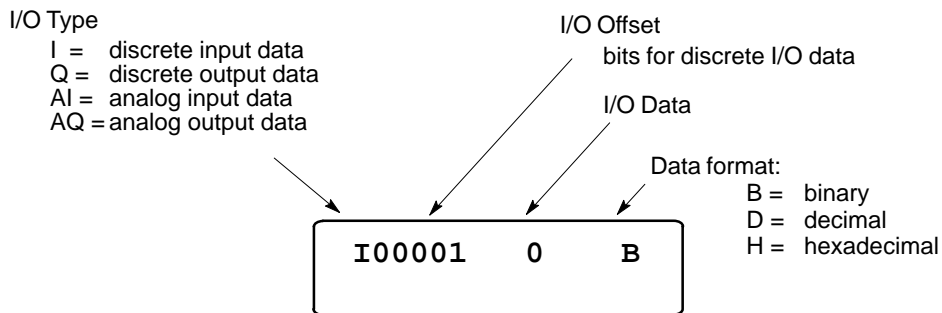

5.2. Changing the Data Display Format: Binary, Hex, Decimal

To change the data format, press the **DEC/HEX** key.

```
I00001  0  B  Binary format
I00001  007E H  Hexadecimal format
I00001  +00216D  Decimal format
```

5.3. Forcing and Unforcing Data

To force data with the Hand-Held Programmer:

1. Place the HHP in the correct display format:
 2. Binary for discrete data.
 3. Hex or decimal for analog data.
2. Select the data to be forced or unforced. For example:

```
I00001  0  B
```

3. Press the **ENT** key. The screen displays:

```
1 Force
2 Unforce
```

4. To force the point, press the **1** key. A cursor appears on the screen, indicating that the HHP is ready for you to enter the intended force value from the keypad.

```
I00001  0  B
—
```

Enter the force value and press the **ENT** key. An asterisk before the value indicates that it is forced.

```
I00001  *1  B
```

The HHP screen also blinks when displaying validators that correspond to a selected range of forced data.

5. To remove the force, press the **ENT** key to display the Force menu. Press the **2** key.

6. DISPLAYING AND CLEARING FAULTS

The Bus Interface Unit reads faults from I/O modules. It can store up to 32 uncleared faults (both BIU and module faults) in its internal fault table. As faults occur, the first 16 are saved in the internal table. They stay there until the faults are cleared; none of these 16 faults is lost if the table overflows. However, for faults 17 through 32, the internal fault table operates as a First-In-First-Out stack. When fault 33 occurs, fault 17 is dropped from the table.



6.1. Displaying Faults

1. From the main menu, press the **1** key (Monitor I/O). This menu appears:

```
1 Monitor I/O
2 Faults
```

2. From this menu, press the **2** key to display the Faults menu.

```
1 First 16 Flts
2 Last 16 Flts
```

3. Press the **1** key or the **2** key to display a set of 16 faults (one fault at a time). For example:

```
Slot #1 Fault#01
CONFIG MISMATCH
```

6.2. Clearing Faults

Pressing the **CLR** key from the Hand-Held Programmer clears all the faults that are presently in the BIU's internal fault tables. Any faults that still exist are reported again.

Clearing faults from the Hand-Held Programmer does not clear faults at the host PLC. To keep the entire system in step and up-to-date, fault clearing should be performed from the host PLC.

7. ERASING FLASH MEMORY

The Bus Interface Unit stores the network configuration and forcing conditions into a FLASH memory chip. One way to erase the forcing conditions and the configuration stored in the chip is to download a new network configuration.

Another way to erase the data from the non volatile memory is to depress simultaneously the HHP keys <CLR> and <M/T> during the powerup diagnostics.

A

- Address selection, DIP switches, 2–7
- Alarm thresholds, configuring for analog input module, 4–14
- Alspa C80–75 PLC, CPU version required for ALSPA CE80–20, 1–13
- Alspa P8–75, software version required, 1–13
- Analog Input Module, configuration steps, 4–11
- Analog inputs, 3–11
 - transmitted on bus, 3–12
- Analog Output Module, configuration steps, 4–7, 4–15
- Analog outputs, 3–13
 - transmitted on bus, 3–13
- Auxiliary I/O Terminal Block, 1–4

B

- Binary data, 4–18
- Bus, connecting to Bus Interface Unit, 2–12
- Bus Interface Unit
 - description, 1–7
 - dimensions, 1–7
 - functional specifications, 1–11
 - fuse, 1–7
 - installing on terminal block, 2–8
 - introduction, 1–4
 - power supply, 1–7
 - removing from terminal block, 2–3
 - terminal block, 1–4, 1–10

C

- Cables, between terminal blocks, 1–10
 - installing, 2–6
- Channel active, configuring for analog input module, 4–12, 4–16
- Clearances required, 2–4
- Communications
 - effect on operating mode, 3–2
 - in Run mode, 3–5
- Communications Variables, 3–8, 3–9, 3–12, 3–13

- Compatibility among devices, 1–13
- COMVs, 3–8, 3–9, 3–12, 3–13, 3–15
- Configuration
 - changes not permitted in Run mode, 3–5
 - selectable features, 1–14
- Control wiring, 2–9
- Current/voltage range
 - configuring for analog input module, 4–12
 - configuring for analog output module, 4–16

D

- Decimal data, 4–18
- Diagnostics, 3–15
- DIN rail
 - installing Terminal Block, 2–5
 - mounting, 2–4
 - removing Terminal Block, 2–15
- DIP switches
 - board address selection, 2–7
 - FIP protocol selection, 2–7
- Discrete Input Module, configuration steps, 4–8
- Discrete inputs, transmitted on bus, 3–8
- Discrete Output Module, configuration steps, 4–10
- Discrete outputs, transmitted on bus, 3–9

E

- Enclosures, 1–5
- Equipment required with Alspa CE80–20, 1–13
- ESD protection, 2–2

F

- Fault Reporting
 - configuring for analog input module, 4–11
 - configuring for analog output module, 4–7, 4–15
 - configuring for discrete input module, 4–8
 - configuring for discrete output module, 4–10
- Faults, displaying and clearing, 4–20, 4–21

Features, 1–2
FIP protocol, selecting type with DIP switches, 2–7
Forcing data, 4–19
 analog inputs, 3–11
 discrete inputs, 3–7
 discrete outputs, 3–10
Fuse, Bus Interface Unit, 1–7, 2–14

G

Grounding
 Bus Interface Unit, 2–11
 system, 2–10

H

Hand-held Programmer
 change data format, binary, hex, decimal, 4–18
 connection to Bus Interface Unit, 4–2
 connector on Bus Interface Unit, 1–7
 Menus, 4–3
 screen format for displaying/forcing data, 4–18
 use not permitted in Run mode, 3–5
 using to display data, 3–6
 using with Remote I/O Scanner, 1–12
Hex data, 4–18
Humidity specification, 1–6

I

I/O data
 analog inputs, 3–11
 analog outputs, 3–13
 discrete inputs, 3–7
 discrete outputs, 3–9
 types and quantities, 3–6
I/O modules
 configure type, 4–7
 introduction, 1–4
 locations for, 1–5
I/O Scanning
 in Idle mode, 3–3
 in Ready mode, 3–4

I/O Terminal Blocks, introduction, 1–4
Input data, 3–11
Input module, analog, configuration steps, 4–7, 4–11, 4–15
Input module, discrete, configuration steps, 4–8
Input power requirements, 1–8
Inputs, default or hold last state
 configuring for analog input module, 4–11
 configuring for discrete input module, 4–8

L

LEDs, 2–13
Locations for I/O modules, 1–5
Logic power, 1–7

M

Modules
 I/O modules, 1–4
 I/O Terminal Blocks, 1–4
 types of, 1–3
Mounting clearances, 2–4
Mounting positions, 1–5
Mounting screws, 2–4

N

Noise
 preventing, 2–9
 providing transient protection, 2–11
 specifications, 1–6

O

Operating modes, 3–2
 idle, 3–2, 3–3
 ready, 3–2, 3–4
 run, 3–2, 3–5
Output defaults, configuring for discrete output module, 4–10
Output module, discrete, configuration steps, 4–10

Outputs

- default or hold last state
 - configuring for analog output module, 4–15
 - configuring for discrete output module, 4–10
- off in idle mode, 3–3

P

- Panel mounting, 2–4
- Pin assignments for the bus connectors, 2–12
- Power
 - specifications, 1–11
 - to Bus Interface Unit, 2–11
 - wiring, general information, 2–9
- Power Supply
 - input power requirements, 1–8
 - specifications, 1–11
 - timing, 1–7
- Preinstallation check, 2–2
- Product compatibility, Index – 1

R

- Rack number, 4–6
- Ready mode, 3–4
 - entered after receiving system configuration, 3–3

S

- Scaling values
 - configuring for analog input module, 4–13

- configuring for analog output module, 4–17

Signal wiring, 2–9

Slot number, configuration, 4–6

Specifications, 1–11

- Voir aussi* individual I/O module datasheets
 - electrical, 1–11
 - environmental, 1–6
 - noise, 1–6
 - temperature, 1–6
 - vibration, 1–6

Standards, 1–6

Status data format, 3–17

T

Temperature specifications, 1–6

Terminal Block

- installing on DIN rail, 2–5
- removing from DIN rail, 2–15

V

Validator data, 3–6

- analog inputs, 3–11
- discrete inputs, 3–7
- discrete outputs, 3–9
- generated and observed in Run mode, 3–5
- set to invalid in idle mode, 3–3

Vibration specification, 1–6

W

Wiring guidelines, 2–9

Index

Chapter 1

5.3.

page 1–11, § 7.

Chapter 2

§ 9., page 2–9

Chapter 3

Chapter 4

4.3. 4.4. 4.5. 4.6.