

**AlspaC693CHS399**  
**New In Stock!**  
**Cegelec Alstom Alspa**

<http://www.pdfsupply.com/automation/cegelec-alstom-alspa/alspa-c80-46/AlspaC693CHS399>

**Alspa C80-46**  
**1-919-535-3180**

Alspa C80-35 Base, Remote Expansion, 5 Slots (700 ft.)

[www.pdfsupply.com](http://www.pdfsupply.com)

**Email:** [sales@pdfsupply.com](mailto:sales@pdfsupply.com)

**Alspa C80–35, C80–25  
and C80–05 PLCs  
Reference Manual**

**ALS 52102 c-en**

First issue: 07–93  
This edition: 06–97

# *Meaning of terms that may be used in this document / Notice to readers*

---

## **WARNING**

**Warning notices are used to emphasize that hazardous voltages, currents, temperatures, or other conditions that could cause personal injury exist or may be associated with use of a particular equipment.**

**In situations where inattention could cause either personal injury or damage to equipment, a Warning notice is used.**

## **Caution**

**Caution notices are used where there is a risk of damage to equipment for example.**

## **Note**

Notes merely call attention to information that is especially significant to understanding and operating the equipment.

This document is based on information available at the time of its publication. While efforts have been made to be accurate, the information contained herein does not purport to cover all details or variations in hardware or software, nor to provide for every possible contingency in connection with installation, operation, or maintenance. Features may be described herein which are not present in all hardware and software systems. Cegelec assumes no obligation of notice to holders of this document with respect to changes subsequently made.

Cegelec makes no representation or warranty, expressed, implied, or statutory with respect to, and assumes no responsibility for the accuracy, completeness, sufficiency, or usefulness of the information contained herein. No warranties of merchantability or fitness for purpose shall apply.

In this publication, no mention is made of rights with respect to trademarks or tradenames that may attach to certain words or signs. The absence of such mention, however, in no way implies there is no protection. Copyright GE Fanuc. All rights, including trade secret rights, are reserved. Unauthorized use of the information is strictly prohibited.

Index letter	Date	Nature of revision
b	September 1995	<p>Changes made to this manual reflect the features of Release 5 (October 1994) of Alspa P8–25/35/05 software for Alspa C80–35 PLCs, Alspa C80–25 PLCs, and Alspa C80–05 Micro PLCs. Additionally, corrections have been made where necessary. The following list describes the major revisions of this manual, as compared to the previous version (ALS 52102 a):</p> <ul style="list-style-type: none"> <li>● This manual includes software-related information about the recently released Model 351 CPU, such as sweep impact (refer to chapter 2) and timing information (refer to appendix A). For additional information about the 351 CPU, refer to the <i>ALS 52117 Alspa C80–35 PLC Installation Manual</i> and the IPI that comes with the CPU.</li> <li>● There is a new Alspa 8000 Micro PLC, Model CE693UDR005, discussed briefly in chapter 2. This Micro PLC has 28 DC inputs and 28 relay outputs. For more information about Model CE693UDD005, refer to the <i>ALS 52119 Alspa C80–05 Micro PLC User’s Manual</i>.</li> <li>● In our effort to improve the quality of Alspa P8 documentation, there are clarifications and corrections in several places within this manual. In addition to minor clarifications, we reorganized and improved the paragraph on Communication Requests beginning on page 4–72.</li> </ul>
c	June 1997	<p>Release 7 for software and CPU</p> <ul style="list-style-type: none"> <li>● Math functions, chapter 4 (trigo, logarithmic, exponential, radian),</li> <li>● Real functions (floating point only CPU 352) chapter 4.</li> <li>● Key switch function, chapter 2.</li> </ul>

# *Revisions*

---

This manual describes the operation, fault handling and Alspa P8 programming instructions for the Alspa C80–35, Alspa C80–25 and Alspa C80–05 Micro programmable controllers. The Alspa C80–35 PLC, Alspa C80–25 and Alspa C80–05 Micro PLC are members of the Alspa 8000 range of programmable logic controllers from Cegelec.

## 1. CONTENT OF THIS MANUAL

This manual contains the following chapters and appendices.

**Chapter 1. Introduction:** provides an overview of the Alspa C80–35 PLC, Alspa C80–25 PLC and Alspa C80–05 Micro PLC and the Alspa P8–25/35/05 instruction set.

**Chapter 2. System Operation:** describes certain System operations of the Alspa C80–35 PLC, Alspa C80–25 PLC or Alspa C80–05 Micro PLC. This includes a discussion of the PLC sweep sequences, the power–up and power–down sequences, clocks and timers, security, I/O and fault handling. It also includes general information for a basic understanding of programming ladder logic.

**Chapter 3. Fault Explanations and Correction:** provides troubleshooting information for an Alspa C80–35, C80–25 or C80–05 PLC. It explains fault descriptions in the PLC fault table and fault categories in the I/O fault table.

**Chapter 4. Alspa P8–25/35/05 Instruction Set:** describes programming instructions available for the Alspa C80–35 PLC, Alspa C80–25 PLC and Alspa C80–05 Micro PLC. The information in this chapter is arranged as sections that correspond to the main program function groups.

**Appendix A. Instruction Timing:** lists the memory size in bytes and execution time in microseconds for each programming instruction. Memory size is the number of bytes required by the function in a ladder diagram application program.

**Appendix B. Interpreting Fault Tables:** describes how to interpret the message structure format when reading the fault tables using Alspa P8–25/35/05 software.

**Appendix C. Instruction Mnemonics:** lists mnemonics that can be typed to display programming instructions while searching through or editing a program.

**Appendix D. Key Functions:** lists the special keyboard assignments used for the Alspa P8–25/35/05 software.

# Preface

---

## 2. RELATED PUBLICATIONS

*ALS 52105 Alspa C80–25 PLC User’s Manual.*

*ALS 52109 MegaBasic Language for PCM Reference Manual and Programmer’s Guide.*

*ALS 52117 Alspa C80–35 PLC Installation Manual.*

*ALS 52118 Alspa C80–35 PLC I/O Module Specifications.*

*ALS 52119 Alspa C80–05 Micro PLC User’s Manual.*

*ALS 52201 Alspa P8–25/35/05 Programming Software for Alspa C80–35, C80–25 and C80–05 PLCs User’s Manual.*

*ALS 52202 Hand–Held Programmer for Alspa C80–35, C80–25 and C80–05 PLCs User’s Manual.*

*ALS 52203 PCM Development Software (PCOP) for Alspa 8000 PLCs User’s Manual.*

*ALS 52307 Alspa CE80–20 – N80 Bus Interface Unit User’s Manual.*

*ALS 52310 FIP Bus Controller (FBC) for Alspa C80–75 PLC User’s Manual.*

*ALS 52311 Alspa CE80–20 FIP Bus Interface Unit User’s Manual.*

*ALS 52313 Alspa CE80–35 Remote I/O Scanner User’s Manual.*

*ALS 52401 High Speed Counter for Alspa C80–35 PLC User’s Manual.*

*ALS 52402 Programmable Coprocessor Module (PCM) and Support Software for Alspa 8000 PLCs User’s Manual.*

*ALS 52403 Axis Positioning Module (APM) for Alspa C80–35 PLC Standard Mode User’s Manual.*

*ALS 52501 N80 Communications Module (NCM) for Alspa C80–35 PLC User’s Manual.*

*ALS 52506 Serial communication modules for Alspa 8000 PLCs User’s Manual.*

*ALS 52511 Alspa C80–35 PLC Bus Controller for Alspa N80 Network (NBC) User’s Manual.*

*ALS 52604 Alphanumeric Display System User’s Manual.*

*ALS 52605 Alphanumeric Display System Reference Manual.*

*ALS 52607 Axis Positioning Module (APM) for Alspa C80–35 PLC – Follower Mode User’s Manual.*

*GFK–0468–ALS Alspa P8–25/35 Important Product Information.*

*GFK–0521 Alphanumeric Display Coprocessor Module Data Sheet.*

### 3. MANUAL NUMBERS

In some cases, Alspa 8000 manuals may be issued with numbers that differ from the one given under "Related Publications" in the Preface of other manuals, or in Important Product Information or data sheets.

The contents are similar.

The table below shows the correspondence between "ALS" and equivalent numbers for the manuals concerned:

<i>ALS Number</i>	<i>Other Number</i>	<i>ALS Number</i>	<i>Other Number</i>
<i>ALS 52113</i>	<i>GFK-0600</i>	<i>ALS 52507</i>	<i>GFK-0074</i>
<i>ALS 52302</i>	<i>GEK-90486-2</i>	<i>ALS 52508</i>	<i>GFK-0868</i>
<i>ALS 52303</i>	<i>GFZ-0043</i>	<i>ALS 52514</i>	<i>GFK-0870</i>
<i>ALS 52404</i>	<i>GFK-0415</i>	<i>ALS 52515</i>	<i>GFK-1026</i>
<i>ALS 52405</i>	<i>GFK-0819</i>	<i>ALS 52523</i>	<i>GFK-1063</i>
<i>ALS 52503</i>	<i>GFK-0585</i>	<i>ALS 52603</i>	<i>GFK-0450</i>

### 4. WE WELCOME YOUR COMMENTS AND SUGGESTIONS

Cegelec strives to produce quality technical documentation. Please take the time to fill in and return the "Reader's Comment" page if you have any remarks or suggestions.

# *Preface*

---

*ALS 52102 c-en      Alspa C80-35, C80-25 and C80-05 PLCs Reference Manual*

**Your main job is:**

- |  |  |
|--|--|
| <input type="checkbox"/> System designer   | <input type="checkbox"/> Programmer            |
| <input type="checkbox"/> Distributor       | <input type="checkbox"/> Maintenance           |
| <input type="checkbox"/> System integrator | <input type="checkbox"/> Operator              |
| <input type="checkbox"/> Installer         | <input type="checkbox"/> Other (specify below) |

**If you would like a personal reply, please fill in your name and address below:**

COMPANY: ..... NAME: .....  
ADDRESS: .....  
..... COUNTRY: .....

**Send this form directly to your CEGELEC sales representative or to this address:**

**Cegelec  
Service Documentation Produit (DPI)  
5 avenue Newton BP 215  
92142 Clamart Cedex  
France  
Fax: +33 (0)1 46 29 12 44**

All comments will be considered by qualified personnel.

REMARKS

Continue on back if necessary

## *Reader's comments*

---

<b>CHAPTER 1 – INTRODUCTION</b> .....	<b>1-1</b>
1. SOFTWARE ARCHITECTURE .....	1-1
2. FAULT HANDLING .....	1-2
3. ALSPA C80-25, C80-35, C80-05 INSTRUCTION SET .....	1-2
3.1. Contacts, Coils and Links .....	1-2
3.2. Timers and Counters .....	1-2
3.3. Math .....	1-3
3.4. Convert Data to Another Type .....	1-3
3.5. Compare Two Numbers .....	1-3
3.6. Manipulate Bit Strings .....	1-3
3.7. Move Data .....	1-3
3.8. Array Move and Search .....	1-3
3.9. Do I/O .....	1-4
3.10. Communicate with Other Modules .....	1-4
3.11. Special Services from the PLC .....	1-4
3.12. Rung Explanation .....	1-4
3.13. Control Functions .....	1-4
3.14. Additional Reference Information .....	1-5
 <b>CHAPTER 2 – SYSTEM OPERATION</b> .....	 <b>2-1</b>
1. PLC SWEEP SUMMARY .....	2-1
1.1. Standard Program Sweep .....	2-2
1.1.1. Sweep Time Calculation .....	2-7
1.1.2. Example of Sweep Time Calculation .....	2-7
1.1.3. Housekeeping .....	2-8
1.1.4. Input Scan .....	2-8
1.1.5. Application Program Logic Scan or Solution .....	2-8
1.1.6. Output Scan .....	2-8
1.1.7. Logic Program Checksum Calculation .....	2-9
1.2. Programmer Communications Window .....	2-9
1.3. System Communications Window (Models 331 and higher) .....	2-10
1.4. PCM Communications with the PLC (Model 331 and higher) .....	2-11
1.5. Standard Program Sweep Variations .....	2-11
1.5.1. Constant Sweep Time Mode .....	2-11
1.5.2. PLC Sweep When in STOP Mode .....	2-12
1.6. Key Switch on 351/352 CPUs: Change Mode and Flash Protect .....	2-12
1.6.1. Using the Release 7 and Later Key Switch .....	2-12
1.6.2. Clearing the Fault Table with the Key Switch .....	2-13
2. PROGRAM ORGANIZATION AND USER REFERENCES/DATA .....	2-15
2.1. Subroutine Blocks (Alspa C80-35 PLC only) .....	2-15
2.1.1. Examples of Using Subroutine Blocks .....	2-16
2.1.2. How Subroutine Blocks are Called .....	2-17
2.1.3. Periodic Subroutines .....	2-18
2.2. User References .....	2-18

# Contents

---

2.3.	Transitions and Overrides .....	2-20
2.4.	Retentiveness of Data .....	2-20
2.5.	Data Types .....	2-21
2.6.	System Status References .....	2-22
2.7.	Function Block Structure .....	2-24
2.7.1.	Format of Ladder Logic Relays .....	2-24
2.7.2.	Format of Program Function Blocks .....	2-24
2.7.3.	Function Block Parameters .....	2-25
2.7.4.	Power Flow In and Out of a Function .....	2-26
3.	POWER-UP AND POWER-DOWN SEQUENCES .....	2-27
3.1.	Power-Up .....	2-27
3.2.	Power-Down .....	2-29
4.	CLOCKS AND TIMERS .....	2-29
4.1.	Elapsed Time Clock .....	2-29
4.2.	Time-of-Day Clock (Model 331 and Model 340/341) .....	2-29
4.3.	Watchdog Timer .....	2-30
4.4.	Constant Sweep Timer .....	2-30
4.5.	Time-Tick Contacts .....	2-30
5.	SYSTEM SECURITY .....	2-31
5.1.	Passwords .....	2-31
5.2.	Privilege Level Change Requests .....	2-32
5.3.	Locking/Unlocking Subroutines .....	2-32
6.	ALSPA C80-35, C80-25 AND MICRO PLC I/O SYSTEM .....	2-34
6.1.	Model 35 I/O Modules .....	2-35
6.2.	I/O Data Formats .....	2-36
6.3.	Default Conditions for Model 35 Output Modules .....	2-36
6.4.	Diagnostic Data .....	2-37
6.5.	Global Data .....	2-37
6.6.	Model 25 I/O Modules .....	2-37
6.7.	Micro PLCs .....	2-38
<b>CHAPTER 3 – FAULT EXPLANATIONS AND CORRECTION .....</b>		<b>3-1</b>
1.	FAULT HANDLING .....	3-2
1.1.	Alarm Processor .....	3-2
1.2.	Classes of Faults .....	3-2
1.3.	System Reaction to Faults .....	3-3
1.3.1.	Fault Tables .....	3-3
1.3.2.	Fault Action .....	3-4
1.4.	Fault References .....	3-4
1.5.	Fault Reference Definitions .....	3-5
1.6.	Additional Fault Effects .....	3-5
1.7.	PLC Fault Table Display .....	3-6

1.8.	I/O Fault Table Display .....	3-7
1.9.	Accessing Additional Fault Information .....	3-8
2.	PLC FAULT TABLE EXPLANATIONS .....	3-9
2.1.	Fault Actions .....	3-10
2.2.	Loss of, or Missing, Option Module .....	3-10
2.3.	Reset of, Addition of, or Extra, Option Module .....	3-10
2.4.	System Configuration Mismatch .....	3-11
2.5.	Option Module Software Failure .....	3-11
2.6.	Program Block Checksum Failure .....	3-12
2.7.	Low Battery Signal .....	3-12
2.8.	Constant Sweep Time Exceeded .....	3-12
2.9.	Application Fault .....	3-13
2.10.	No User Program Present .....	3-13
2.11.	Corrupted User Program on Power-Up .....	3-14
2.12.	Password Access Failure .....	3-14
2.13.	PLC CPU System Software Failure .....	3-15
2.14.	Communications Failure During Store .....	3-17
3.	I/O FAULT TABLE EXPLANATIONS .....	3-18
3.1.	Loss of I/O Module .....	3-19
3.2.	Addition of I/O Module .....	3-19

## CHAPTER 4 – ALSPA P8-25/35/05 INSTRUCTION SET ..... 4-1

1.	RELAY FUNCTIONS .....	4-2
1.1.	Using Contacts .....	4-2
1.2.	Using Coils .....	4-2
1.3.	Normally Open Contact —   — .....	4-3
1.4.	Normally Closed Contact — / — .....	4-3
1.5.	Coil —( )— .....	4-4
1.6.	Negated Coil —(/)— .....	4-4
1.7.	Retentive Coil —(M)— .....	4-4
1.8.	Negated Retentive Coil —(/M)— .....	4-4
1.9.	Positive Transition Coil —(◻) .....	4-5
1.10.	Negative Transition Coil —(◻) .....	4-5
1.11.	SET Coil —(S)— .....	4-5
1.12.	RESET Coil —(R)— .....	4-6
1.13.	Retentive SET Coil —(SM)— .....	4-6
1.14.	Retentive RESET Coil —(RM)— .....	4-7
1.15.	Links .....	4-7
1.16.	Continuation Coils (————<+>) and Contacts (<+>————) .....	4-8
2.	TIMERS AND COUNTERS .....	4-9
2.1.	Function Block Data Required for Timers and Counters .....	4-9

# Contents

---

2.2.	ONDTR	4-10
2.2.1.	Parameters	4-12
2.2.2.	Valid Memory Types	4-12
2.3.	TMR	4-13
2.3.1.	Parameters	4-14
2.3.2.	Valid Memory Types	4-14
2.4.	OFDT	4-15
2.4.1.	Parameters	4-16
2.4.2.	Valid Memory Types	4-17
2.5.	UPCTR	4-18
2.5.1.	Parameters	4-18
2.5.2.	Valid Memory Types	4-18
2.6.	DNCTR	4-19
2.6.1.	Parameters	4-20
2.6.2.	Valid Memory Types	4-20
3.	MATH FUNCTIONS	4-23
3.1.	Standard Math Functions (ADD, SUB, MUL, DIV)	4-23
3.1.1.	Parameters	4-24
3.1.2.	Valid Memory Types	4-24
3.1.3.	Math Functions and Data Types	4-25
3.2.	MOD (INT, DINT)	4-27
3.2.1.	Parameters	4-27
3.2.2.	Valid Memory Types	4-28
3.3.	SQRT (INT, DINT)	4-29
3.3.1.	Parameters	4-29
3.3.2.	Valid Memory Types	4-30
3.4.	Trig Function (SIN, COS, TAN, ASIN, ACOS, ATAN)	4-30
3.4.1.	Parameters	4-31
3.4.2.	Valid Memory Types	4-31
3.5.	Logarithmic/Exponential Functions (LOG, LN, EXP, EXPT)	4-32
3.5.1.	Parameters	4-32
3.5.2.	Valid Memory Types	4-33
3.6.	Radian Conversion (RAD, DEG)	4-34
3.6.1.	Parameters	4-34
3.6.2.	Valid Memory Types	4-34
4.	RELATIONAL FUNCTIONS	4-35
4.1.	Comparisons	4-35
4.1.1.	Parameters	4-36
4.1.2.	Valid Memory Types	4-36
4.2.	RANGE (INT, DINT, WORD, DWORD)	4-37
4.2.1.	Parameters	4-37
4.2.2.	Valid Memory Types	4-38
5.	BIT OPERATION FUNCTIONS	4-40
5.1.	AND and OR (WORD)	4-41
5.1.1.	Parameters	4-42
5.1.2.	Valid Memory Types	4-42
5.2.	XOR (WORD)	4-44
5.2.1.	Parameters	4-44
5.2.2.	Valid Memory Types	4-45
5.3.	NOT (WORD)	4-46
5.3.1.	Parameters	4-46

5.3.2.	Valid Memory Types .....	4-46
5.4.	SHL and SHR (WORD) .....	4-47
5.4.1.	Parameters .....	4-48
5.4.2.	Valid Memory Types .....	4-48
5.5.	ROL and ROR (WORD) .....	4-49
5.5.1.	Parameters .....	4-49
5.5.2.	Valid Memory Types .....	4-50
5.6.	BTST (WORD) .....	4-51
5.6.1.	Parameters .....	4-51
5.6.2.	Valid Memory Types .....	4-51
5.7.	BSET and BCLR (WORD) .....	4-52
5.7.1.	Parameters .....	4-53
5.7.2.	Valid Memory Types .....	4-53
5.8.	BPOS (WORD) .....	4-54
5.8.1.	Parameters .....	4-54
5.8.2.	Valid Memory Types .....	4-54
5.9.	MSKCMP (WORD, DWORD) .....	4-56
5.9.1.	Parameters .....	4-57
5.9.2.	Valid Memory Types .....	4-57
6.	DATA MOVE FUNCTIONS .....	4-60
6.1.	MOVE (BIT, INT, WORD) .....	4-60
6.1.1.	Parameters .....	4-61
6.1.2.	Valid Memory Types .....	4-62
6.2.	BLKMOV (INT, WORD, REAL) .....	4-63
6.2.1.	Parameters .....	4-63
6.2.2.	Valid Memory Types .....	4-64
6.3.	BLKCLR (WORD) .....	4-65
6.3.1.	Parameters .....	4-65
6.3.2.	Valid Memory Types .....	4-65
6.4.	SHFR (BIT, WORD) .....	4-66
6.4.1.	Parameters .....	4-67
6.4.2.	Valid Memory Types .....	4-67
6.5.	BITSEQ (BIT) .....	4-69
6.5.1.	Memory Required for a Bit Sequencer .....	4-69
<b>CHAPTER 5 – ALSPA P8–25/35/05 INSTRUCTION SET .....</b>		<b>4-70</b>
6.5.2.	Parameters .....	4-70
6.5.3.	Valid Memory Types .....	4-71
6.6.	COMMREQ .....	4-72
6.6.1.	Command Block .....	4-72
6.6.2.	Parameters .....	4-73
6.6.3.	Valid Memory Types .....	4-74
7.	TABLE FUNCTIONS .....	4-75
7.1.	ARRAY_MOVE (INT, DINT, BIT, BYTE, WORD) .....	4-76
7.1.1.	Parameters .....	4-77
7.1.2.	Valid Memory Types .....	4-77
7.2.	SRCH_EQ and SRCH_NE (INT, DINT, BYTE, WORD) SRCH_GT and SRCH_LT SRCH_GE and SRCH_LE .....	4-79
7.2.1.	Parameters .....	4-80
7.2.2.	Valid Memory Types .....	4-80

# Contents

---

8.	CONVERSION FUNCTIONS	4-82
8.1.	↳ (INT)	4-82
8.1.1.	Parameters	4-82
8.1.2.	Valid Memory Types	4-83
8.2.	↳ (BCD-4, REAL)	4-83
8.2.1.	Parameters	4-84
8.2.2.	Valid Memory Types	4-84
8.3.	—>DINT (REAL)	4-85
8.3.1.	Parameters	4-85
8.3.2.	Valid Memory Types	4-86
8.4.	—>REAL (INT, DINT, BCD-4, WORD)	4-86
8.4.1.	Parameters	4-87
8.4.2.	Valid Memory Types	4-87
8.5.	—>WORD (REAL)	4-87
8.5.1.	Parameters	4-88
8.5.2.	Valid Memory Types	4-88
8.6.	TRUN (INT, DINT)	4-88
8.6.1.	Parameters	4-89
8.6.2.	Valid Memory Types	4-89
9.	CONTROL FUNCTIONS	4-90
9.1.	CALL	4-91
9.2.	DOIO	4-92
9.2.1.	Parameters	4-93
9.2.2.	Valid Memory Types	4-93
9.2.3.	Enhanced DO I/O Function for the 331 and Higher CPUs	4-95
9.3.	END	4-97
9.4.	MCR	4-97
9.5.	ENDMCR	4-100
9.6.	JUMP	4-101
9.7.	LABEL	4-103
9.8.	COMMENT	4-104
9.9.	SVCREQ	4-104
9.9.1.	Parameters	4-105
9.9.2.	Valid Memory Types	4-106
9.9.3.	SVCREQ 6: Change/Read Number of Words to Checksum	4-106
9.9.3.1.	To Read the Current Word Count	4-107
9.9.3.2.	To Set a New Word Count	4-107
<b>CHAPTER 6 – ALSPA P8-25/35/05 INSTRUCTION SET</b>		<b>4-108</b>
9.9.4.	SVCREQ 7: Change/Read Time-of-Day Clock	4-109
9.9.4.1.	Parameter Block Contents	4-111
9.9.4.2.	To Change/Read Date and Time using BCD Format	4-111
9.9.4.3.	To Change/Read Date and Time using Packed ASCII with Embedded Colons Format	4-112
9.9.5.	SVCREQ 13: Shut Down (Stop) PLC	4-113
9.9.6.	SVCREQ 14: Clear Fault Tables	4-114
9.9.7.	SVCREQ 15: Read Last-Logged Fault Table Entry	4-115
9.9.8.	SVCREQ 16: Read Elapsed Time Clock	4-118
9.9.9.	SVCREQ 18: Read I/O Override Status	4-119
9.9.10.	SVCREQ 23: Read Master Checksum	4-120
9.9.11.	SVCREQ 26/30: Interrogate I/O	4-121
9.9.12.	SVCREQ 29: Read Elapsed Power Down Time	4-122

9.10.	PID .....	4-123
9.10.1.	Parameters .....	4-124
9.10.2.	Valid Memory Types .....	4-124
9.10.3.	PID Parameter Bloc .....	4-125
9.10.4.	Operation of the PID Instruction .....	4-126
9.10.5.	Internal Parameters in RefArray .....	4-131
9.10.6.	PID Algorithm Selection (PIDISA or PIDIND) and Gains .....	4-131
9.10.7.	CV Amplitude and Rate Limits .....	4-132
9.10.8.	Sample Period and PID Block Scheduling .....	4-133
9.10.9.	Determining the Process Characteristics .....	4-133
9.10.10.	Setting User Parameters Including Tuning Loop Gains .....	4-134
9.10.11.	Setting Loop Gains — Ziegler and Nichols Tuning Approach .....	4-135
9.10.12.	Sample PID Call .....	4-136
<b>APPENDIX A – INSTRUCTION TIMING .....</b>		<b>A-1</b>
<b>APPENDIX B – INTERPRETING FAULTS USING ALSPA P8-25/35/05 SOFTWARE ..</b>		<b>B-1</b>
1.	PLC FAULT TABLE .....	B-3
1.1.	Long/Short Indicator .....	B-4
1.2.	Spare .....	B-4
1.3.	Rack .....	B-4
1.4.	Slot .....	B-4
1.5.	Task .....	B-4
1.6.	PLC Fault Group .....	B-5
1.7.	Fault Action .....	B-5
1.8.	Error Code .....	B-6
1.9.	Fault Extra Data .....	B-8
1.9.1.	Corrupted User RAM Group .....	B-8
1.9.2.	PLC CPU Hardware Failure (RAM Failure) .....	B-8
1.10.	PLC Fault Time Stamp .....	B-8
2.	I/O FAULT TABLE .....	B-9
2.1.	Long/Short Indicator .....	B-10
2.2.	Reference Address .....	B-10
2.3.	I/O Fault Address .....	B-10
2.4.	Rack .....	B-11
2.5.	Slot .....	B-11
2.6.	Point .....	B-11
2.7.	I/O Fault Group .....	B-11
2.8.	I/O Fault Action .....	B-12
2.9.	I/O Fault Specific Data .....	B-12
2.10.	Symbolic Fault Specific Data .....	B-12
2.11.	Fault Actions for Specific Faults .....	B-12
2.12.	I/O Fault Time Stamp .....	B-12

# Contents

---

<b>APPENDIX C – INSTRUCTION MNEMONICS .....</b>	<b>C-1</b>
<b>APPENDIX D – KEY FUNCTIONS .....</b>	<b>D-1</b>
<b>APPENDIX E – USING FLOATING-POINT NUMBERS .....</b>	<b>E-1</b>
1. FLOATING-POINT NUMBERS .....	E-1
2. VALUES OF FLOATING-POINT NUMBERS .....	E-2
3. ERRORS IN FLOATING-POINT NUMBERS AND OPERATIONS .....	E-4
4. ENTERING AND DISPLAYING FLOATING-POINT NUMBERS .....	E-5

Figure 2.1 – PLC Sweep .....	2-3
Figure 2.2 – Programmer Communications Window Flow Chart .....	2-9
Figure 2.3 – System Communications Flow Chart .....	2-10
Figure 2.4 – PCM Communications with the PLC .....	2-11
Figure 2.5 – Power-Up Sequence .....	2-28
Figure 2.6 – Time-Tick Contact Timing Diagram .....	2-30
Figure 2.7 – Alspa C80-35 I/O Structure .....	2-34
Figure 4.1 – Independent Term Algorithm (PIDIND) .....	4-132

# Tables

---

Table 2.1 – Sweep Time Contribution	2-4
Table 2.2 – I/O Scan Time Contribution for Alspa C80-35 Modules (in milliseconds)	2-5
Table 2.3 – I/O Scan Time Contribution for Alspa C80-35 351/352 Module (in milliseconds)	2-6
Table 2.4 – Example Sweep Time Calculation (for an Alspa C80-35 Model 331 PLC)	2-7
Table 2.5 – Register References	2-18
Table 2.6 – Discrete References	2-19
Table 2.7 – Data Types	2-21
Table 2.8 – System Status References	2-22
Table 2.8 – System Status References – Continued	2-23
Table 2.9 – Model 35 I/O Modules	2-35
Table 2.10 – Model 25 I/O Modules	2-37
Table 2.11 – Micro PLC Models	2-38
Table 3.1 – Fault Summary	3-3
Table 3.2 – Fault Actions	3-4
Table 4.1 – Types of Contacts	4-2
Table 4.2 – Types of Coils	4-3
Table 4.3 – Service Request Functions	4-104
Table 4.4 – PID Parameters Overview	4-125
Table 4.5 – PID Parameters Details	4-127
Table 4.5 – PID Parameters Details (Continued)	4-128
Table 4.5 – PID Parameters Details (Continued)	4-129
Table 4.5 – PID Parameters Details (Continued)	4-130
Table A.1 – Instruction Timing	A-2
Table A.1 – Instruction Timing – Continued	A-3
Table A.1 – Instruction Timing – Continued	A-4
Table A.1 – Instruction Timing – Continued	A-5
Table A.1 – Instruction Timing – Continued	A-6
Table A.1 – Instruction Timing – Continued	A-7
Table A.1 – Instruction Timing – Continued	A-8
Table A.2 – Instruction Sizes for 351 and 352 CPUs	A-8
Table B.1 – PLC Fault Groups	B-5
Table B.2 – PLC Fault Actions	B-5
Table B.3 – Alarm Error Codes for PLC CPU Software Faults	B-6
Table B.4 – Alarm Error Codes for PLC Faults	B-7
Table B.5 – PLC Fault Data – Illegal Boolean Opcode Detected	B-8
Table B.6 – PLC Fault Time Stamp	B-8
Table B.7 – I/O Fault Table Format Indicator Byte	B-10
Table B.8 – I/O Reference Address	B-10
Table B.9 – I/O Reference Address Memory Type	B-10
Table B.10 – I/O Fault Groups	B-11
Table B.11 – I/O Fault Actions	B-12
Table B.12 – I/O Fault Specific Data	B-12
Table B.13 – I/O Fault Time Stamp	B-12

# Chapter *1* Introduction

---

---

The Alspa C80–35 PLC, Alspa C80–25 PLC and Alspa C80–05 Micro PLC are members of the Cegelec Alspa 8000 PLC range of programmable logic controllers (PLCs). They are easy to install and configure, offer advanced programming features, and are compatible with the Alspa C80–75 PLC.

The Alspa C80–25 PLC provides a cost-effective platform for low I/O count applications. The primary objectives of the Alspa C80–25 PLC are:

- To provide a small PLC that is easy to use, install, upgrade and maintain.
- To provide a cost-effective family-compatible PLC.
- To provide easier system integration through standard communication hardware and protocols.

The Alspa C80–05 Micro PLC also provides a cost-effective platform for lower I/O count applications. The primary objectives of the Micro PLC are the same as those for the Alspa C80–25. In addition, the Micro PLC offers the following:

- The Micro PLC has the CPU, power supply, inputs and outputs all built into one small device.
- Most models also have a high speed counter.
- Because the CPU, power supply, inputs and outputs are all built into one device, it is very easy to configure.

## **1. SOFTWARE ARCHITECTURE**

The software structure for the Alspa C80–35 PLC (except 351 models) and Alspa C80–25 PLC uses an architecture that manages memory and execution priority in the 80188 microprocessor. Models 351 and 352 uses an 80386 EX microprocessor. The Alspa C80–05 Micro PLC uses the H8 microprocessor. This operation supports both program execution and basic housekeeping tasks such as diagnostic routines, input/output scanners and alarm processing. The system software also contains routines to communicate with the programmer. These routines provide for the upload and download of application programs, return of status information, and control of the PLC.

In the Alspa C80–35 PLC, the application (user logic) program which controls the end process to which the PLC is applied is controlled by a dedicated Instruction Sequencer Coprocessor (ISCP). The ISCP is implemented in hardware in the Model 313 and higher and in software in the Model 311 systems, and the Micro PLC. The 80188 microprocessor and the ISCP can execute simultaneously, allowing the microprocessor to service communications while the ISCP is executing the bulk of the application program; however, the microprocessor must execute the non-boolean function blocks.

## 2. FAULT HANDLING

Faults occur in the Alspa C80–35 PLC, Alspa C80–25 and Alspa C80–05 Micro PLC when certain failures or conditions happen that affect the operation and performance of the system. These conditions may affect the ability of the PLC to control a machine or process. Other conditions may only act as an alert, such as a low battery signal to indicate that the voltage of the battery protecting the memory is low and should be replaced. The condition or failure is called a fault.

Faults are handled by a software alarm processor function which records the faults in either the PLC fault table or the I/O fault table. (The Model 331 and Model 340/341 CPUs also time–stamp the faults.) These tables can be displayed on the PLC Fault Table and I/O Fault Table screens in Alspa P8–25/35/05 software using the control and status functions.

## 3. ALSPA C80–25, C80–35, C80–05 INSTRUCTION SET

Programming consists of creating an application program for a PLC. Because Alspa C80–35, C80–25 and C80–05 Micro PLCs have a common instruction set, they can all be programmed using the same software. Chapter 4 of this manual describes the instruction set used to create ladder logic programs for the Alspa C80–35, C80–25 and C80–05 Micro PLCs.

If the Alspa P8–25/35/05 programming software is not yet installed, please refer to the *ALS 52201 Alspa P8–25/35/05 Programming Software for Alspa C80–35, C80–25 and C80–05 PLCs User's Manual*, for instructions. The user's manual explains how to create, transfer, edit and print programs.

Configuration is the process of assigning logical addresses, as well as other characteristics, to the hardware modules in the system. It may be done either before or after programming, using the configuration software which is part of Alspa P8–25/35/05 software; however, it is recommended that configuration be done first. If that has not been done, you should refer to the *ALS 52201 Alspa P8–25/35/05 Programming Software for Alspa C80–35, C80–25 and C80–05 PLCs User's Manual*, to decide whether it is best to begin programming at this time.

### 3.1. Contacts, Coils and Links

The most basic elements of a program are relay functions, which are described in chapter 4, § 1. *Relay Functions*. These contacts and coils represent machine inputs and outputs, and can be used to control the flow of logic through the program. They enable or prevent the execution of other program functions in a rung and indicate the states of outputs. The Alspa P8 software provides many types of contacts and coils for maximum programming flexibility.

### 3.2. Timers and Counters

For information about using an on–delay or stopwatch–type timer, as well as up and down counters, refer to chapter 4, § 2. *Timers and Counters*.

### 3.3. Math

Math functions include addition, subtraction, multiplication, division, modulo division and square root. Release 7 also provides support for floating point math with the CPU 352 only. Floating point math uses the REAL data type. Additional math instructions supported by the CPU 352 include trigonometric, logarithmic/exponential and radian conversion. These functions are explained in chapter 4, § 3. *Math Functions*.

Each math function operates on two signed or double precision signed integer numbers of the same type. If the numbers you are working with are not the same type (for example, if one is a signed integer and the other is in 4-digit BCD format), you must first program one of the conversion functions (described in § 8.) to make the input types match.

### 3.4. Convert Data to Another Type

Many program functions (like the math functions) operate on numbers which must be of the same type. Use the conversion functions, described in chapter 4, § 8. *Conversion Functions* if you need to change a number to word, BCD, or signed integer format.

### 3.5. Compare Two Numbers

To compare two numbers (which must be the same type), to see whether one is greater than, equal to, or less than the other, use one of the relational functions described in chapter 4, § 4. *Relational Functions*.

### 3.6. Manipulate Bit Strings

Chapter 4, § 5. *Bit Operation Functions*, contains information about data move and boolean operations on data that is in the form of bit strings:

1. To perform boolean operations (AND, OR, XOR, NOT) on two bit strings of the same length.
2. To create an output string that is a copy of an input bit string, but with its bits inverted, shifted, or rotated. Also, use the data move functions to clear an area of memory and fill it with typed data.

### 3.7. Move Data

Refer to chapter 4, § 6. *Data Move Functions*, to create program logic that will:

1. Copy data to another location. Data is copied as individual bits.
2. Move a block of constants into memory.
3. Clear an area of discrete or register reference memory.
4. Shift data from one memory location to another, capturing the data that has been shifted out.
5. Perform a bit sequence shift through an array of bits.

### 3.8. Array Move and Search

To search for array values and compare them to a specified value or copy a specified number of data elements, use the table functions described in chapter 4, § 7. *Table Functions*.

### 3.9. Do I/O

To perform an immediate I/O update of rack-mounted modules in the system, use the DO I/O function described in chapter 4, § 9. *Control Functions*.

### 3.10. Communicate with Other Modules

If the CPU must communicate with an intelligent module in the system (for example, to send data to a PCM), use a COMMREQ function. See chapter 4, § 9. *Control Functions*.

### 3.11. Special Services from the PLC

Use the SVCREQ function described in chapter 4, § 9. *Control Functions* to:

1. Change/read the checksum task state and number of words to checksum.
2. Change/read the time-of-day clock state and values.
3. Shut down the PLC.
4. Clear the fault tables.
5. Read the last-logged fault table entry.
6. Read the elapsed time clock.
7. Read the I/O override status.
8. Read Master Checksum.
9. Interrogate I/O.
10. Read Elapsed Power Down Time.

### 3.12. Rung Explanation

To add rung comment text to the program, use the COMMENT function described in chapter 4, § 9. *Control Functions*.

### 3.13. Control Functions

Use the MCR function to execute part of the program with negative logic, or the JUMP function to skip part of the program entirely. See chapter 4, § 9. *Control Functions* for information.

### **3.14. Additional Reference Information**

Appendix A lists the memory size in bytes and the execution time in microseconds for each programming instruction described in chapter 4.

Appendix B describes how to interpret the message structure format when reading the PLC and I/O fault tables.

Refer to appendix C for a listing of the instruction mnemonics used with Alspa P8–25/35/05 software.

Refer to appendix D for a listing of the special keyboard assignments used with Alspa P8–25/35/05 software.



# Chapter 2 *System Operation*

---

---

This chapter describes certain system operations of the Alspa C80–35 PLC, Alspa C80–25 PLC and C80–05 Micro PLCs. These system operations include:

- A summary of PLC sweep sequences (see § 1.).
- Program organization and user references/data (see § 2.).
- Power–up and power–down sequences (see § 3.).
- Clocks and timers (see § 4.).
- System security through password assignment (see § 5.).
- Model 35 I/O modules (see § 6.).
- Model 25 and Micro I/O (see § 6.).

## **1. PLC SWEEP SUMMARY**

The logic program in the Alspa C80–35, Alspa C80–25 and Micro PLCs execute repeatedly until stopped by a command from the programmer or a command from another device. The sequence of operations necessary to execute a program one time is called a sweep. In addition to executing the logic program, the sweep includes obtaining data from input devices, sending data to output devices, performing internal housekeeping, servicing the programmer and servicing other communications.

The Alspa C80–35, Alspa C80–25 and Micro PLCs normally operate in Standard Program Sweep mode. Other operating modes include STOP with I/O Disabled mode, STOP with I/O Enabled mode, and Constant Sweep mode. Each of these modes, described in this chapter, is controlled by external events and application configuration settings. The PLC makes the decision regarding its operating mode at the start of every sweep.

## 1.1. Standard Program Sweep

Standard Program Sweep mode normally runs under all conditions. The CPU operates by executing an application program, updating I/O, and performing communications and other tasks. This occurs in a repetitive cycle called the CPU sweep. There are seven parts to the execution sequence of the Standard Program Sweep:

1. Start-of-sweep housekeeping.
2. Input scan (read inputs).
3. Application program logic solution.
4. Output scan (update outputs).
5. Programmer service.
6. Non-programmer service.
7. Diagnostics.

All of these steps, except programmer service, execute every sweep. Programmer service only occurs if a board fault has been detected or if the programming device issues a service request. The sequence of the standard program sweep is shown in the following figure.

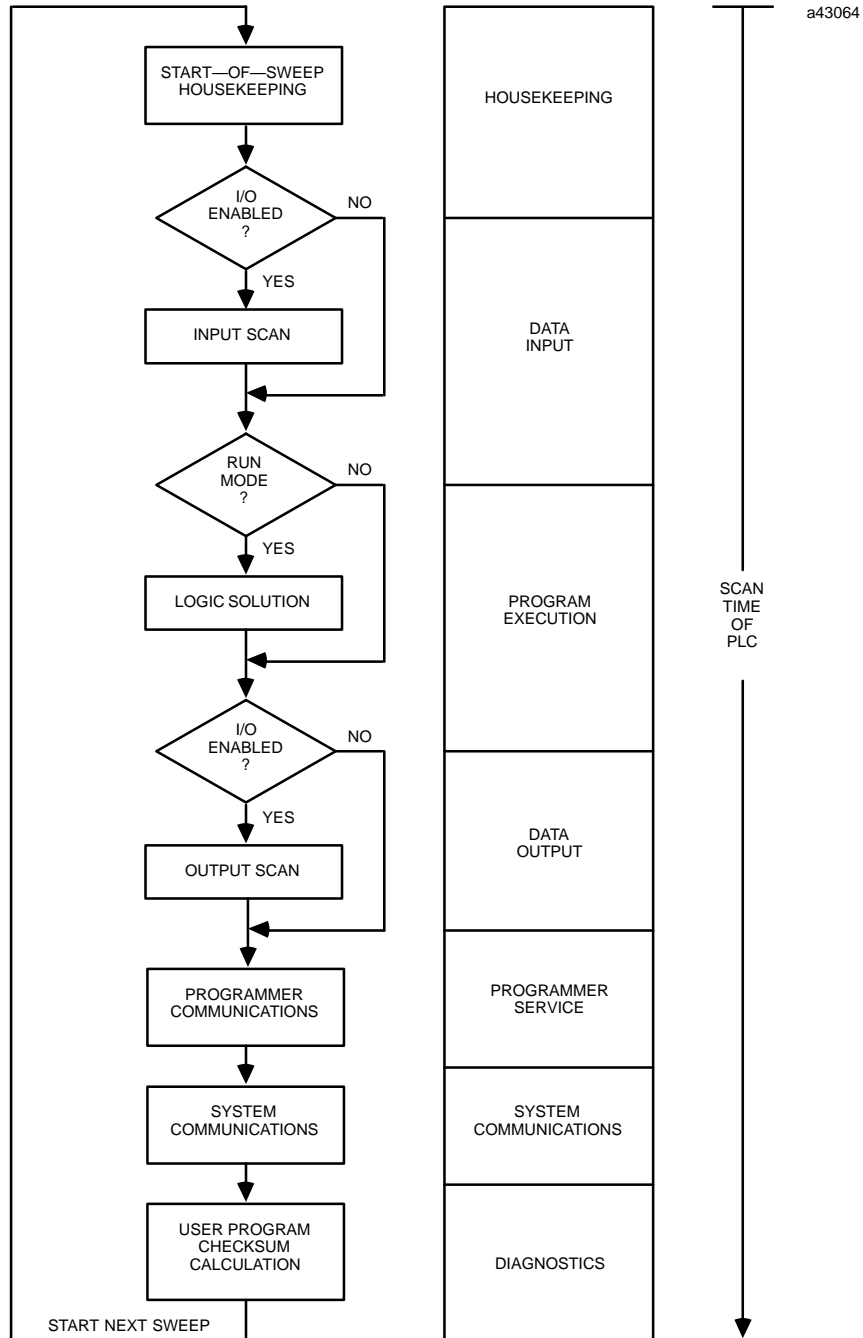

Figure 2.1 – PLC Sweep

As shown in the PLC sweep sequence, several items are included in the sweep. These items contribute to the total sweep time as shown in the following table.

**Table 2.1 – Sweep Time Contribution**

Sweep Element	Description	Time Contribution (ms) <sup>4</sup>						
		Micro	211	311/313	331	341	351	
Housekeeping	<ul style="list-style-type: none"> <li>● Calculate sweep time.</li> <li>● Schedule start of next sweep.</li> <li>● Determine mode of next sweep.</li> <li>● Update fault reference tables.</li> <li>● Reset watchdog timer.</li> </ul>	0.368	0.898	0.714	0.705	0.424	0.279	
Data Input	Input data is received from input and option modules.	( <sup>5</sup> )	See Table 2.2 for scan time contributions.					
Program Execution	User logic is solved.	Execution time is dependent upon the length of the program and the type of instructions used in the program. Instruction execution times are listed in Appendix A.						
Data Output	Output data is sent to output and option modules.	0.1656	See Table 2.2 for scan time contributions.					
Service External Devices	Service requests from programming devices and intelligent modules are processed. <sup>1</sup>	HHP	1.93	6.526	4.426	4.524	2.476	0.334
		P8	0.380	3.536	2.383	2.454	1.248	0.517
		PCM <sup>2</sup>	N/A	N/A	N/A	3.337	1.943	0.482
Reconfiguration	Slots with faulted modules and empty slots are monitored.	N/A <sup>6</sup>	N/A	0.458	0.639	0.463	0.319	
Diagnostics	Verify user program integrity (time contribution is the time required per word checksummed each sweep). <sup>3</sup>	N/A <sup>7</sup>	0.083	0.050	0.048	0.031	0.010	

1. The scan time contribution of external device service is dependent upon the mode of the communications window in which the service is processed. If the window mode is **LIMITED**, a maximum of 6 ms will be spent during that window. If the window mode is **RUN-TO-COMPLETION**, a maximum of 50 ms can be spent in that window, depending upon the number of requests which are presented simultaneously.
2. These measurements were taken with the PCM physically present but not configured and with no application task running on the PCM.
3. The number of words checksummed each sweep can be changed with the SVCREQ function block.
4. These measurements were taken with an empty program and the default configuration. The Alspa C80–35 PLCs were in an empty 10-slot rack with no extension racks connected.
5. The data input time for the Micro PLC can be determined as follows: 0.365 ms. (fixed scan) + 0.036 ms. (filter time) x (total sweep time)/0.5 ms.
6. Since the Micro PLC has a static set of I/O, reconfiguration is not necessary.
7. Since the user program for the Micro PLC is in Flash memory, it will not be checked for integrity.

**Table 2.2 – I/O Scan Time Contribution for Alspa C80–35 Modules (in milliseconds)**

Module Type		CPU Model						
		311/313	331			341		
			Main Rack	Expansion Rack	Remote Rack	Main Rack	Expansion Rack	Remote Rack
8-point discrete input		0.076	0.054	0.095	0.255	0.048	0.089	0.249
16-point discrete input		0.075	0.055	0.097	0.257	0.048	0.091	0.250
32-point discrete input		0.094	0.094	0.126	0.335	0.073	0.115	0.321
8-point discrete output		0.084	0.059	0.097	0.252	0.053	0.090	0.246
16-point discrete output		0.083	0.061	0.097	0.253	0.054	0.090	0.248
32-point discrete output		0.109	0.075	0.129	0.333	0.079	0.114	0.320
8-point combination input/output		0.165	0.141	0.218	0.529	0.098	0.176	0.489
4-channel analog input		0.151	0.132	0.183	0.490	0.117	0.160	0.462
2-channel analog output		0.161	0.138	0.182	0.428	0.099	0.148	0.392
High-Speed Counter		2.070	2.190	2.868	5.587	1.580	2.175	4.897
APM (1-axis)		2.330	2.460	3.175	6.647	1.750	2.506	5.899
NCM	no devices	0.041	0.054	0.063	0.128	0.038	0.048	0.085
	8 x 64-point devices	11.420	11.570	13.247	21.288	9.536	10.648	19.485
NCM+	no devices	0.887	0.967	1.164	1.920	0.666	0.901	1.626
	32 x 64-point devices	4.120	6.250	8.529	21.352	5.043	7.146	20.052
PCM 311	not configured, or no application task	N/A	3.350	N/A	N/A	1.684	N/A	N/A
	read 128 %R as fast as possible	N/A	4.900	N/A	N/A	2.052	N/A	N/A
ADC 311		N/A	3.340	N/A	N/A	1.678	N/A	N/A
16-channel analog input (current or voltage)		1.370	1.450	1.937	4.186	1.092	1.570	3.796

Information (additional to what is provided on the previous page) for the Micro PLC is included in the *ALS 52119 Alspa C80–05 Micro PLC User's Manual* and will be included in this table in the manual that will accompany next release of the Alspa P8–25/35/05 software.

**Table 2.3 – I/O Scan Time Contribution for Alspa C80–35 351/352 Module (in milliseconds)**

Module Type		CPU		
		351/352		
		Main Rack	Expansion Rack	Remote Rack
8-point discrete input		0.030	0.055	0.026
16-point discrete input		0.030	0.055	0.206
32-point discrete input		0.043	0.073	0.269
8-point discrete output		0.030	0.053	0.197
16-point discrete output		0.030	0.053	0.197
32-point discrete output		0.042	0.070	0.259
Combination discrete input/output		0.060	0.112	0.405
4-channel analog input		0.075	0.105	0.396
2-channel analog output		0.058	0.114	0.402
16-channel analog input (current or voltage)		0.978	1.446	3.999
8-channel analog output		1.274	1.988	4.472
Combination analog input/output		1.220	1.999	4.338
High Speed Counter		1.381	2.106	5.221
APM (1-axis)		1.527	2.581	6.388
I/O Processor		1.574	2.402	6.388
Ethernet Interface (no connection)		0.038	0.041	0.053
NCM	no devices	0.911	1.637	5.020
	8 x 64-point devices	8.826	16.932	21.179
NCM+	no devices	0.567	0.866	1.830
	32 x 64-point devices	1.714	2.514	5.783
NBC	no devices	0.798	1.202	2.540
	32–64 pt. devices	18.382	25.377	70.777
PCM 311	not configured, or no application task	0.476	N/A	N/A
	read 128 %R as fast as possible	0.485	N/A	N/A
ADC (no task)		0.476	N/A	N/A

### 1.1.1. Sweep Time Calculation

Table 2.1 lists seven items that contribute to the sweep time of the PLC. The sweep time consists of fixed times (housekeeping and diagnostics) and variable times. Variable times vary according to the I/O configuration, size of the user program, and the type of programming device connected to the PLC.

### 1.1.2. Example of Sweep Time Calculation

An example of the calculations for determining the sweep time for an Alspa C80–35 model 331 PLC are shown in the following table.

The modules and instructions used for these calculations are listed below:

- Input modules: five 16–point Model 35 input modules.
- Output modules: four 16–point Model 35 output modules.
- Programming instructions: A 1200–step program consisting of 700 boolean instructions (LD, AND, OR, etc.), 300 output coils (OUT, OUTM, etc.), and 200 math functions (ADD, SUB, etc.).

**Table 2.4 – Example Sweep Time Calculation (for an Alspa C80–35 Model 331 PLC)**

Sweep Component	Calculation	Time Contribution		
		wo/ Programmer	w/ HHP	w/ P8
Housekeeping	0.705 ms	0.705 ms	0.705 ms	0.705 ms
Data Input	$0.055 \times 5 = 0.275$ ms	0.275 ms	0.275 ms	0.275 ms
Program Execution	$700 \times 0.4 \mu\text{s} + 300 \times 0.5 \mu\text{s} + 200 \times 51.2 \mu\text{s} = 10.7$ ms	10.7 ms	10.7 ms	10.7 ms
Data Output	$0.061 \times 4 = 0.244$ ms	0.244 ms	0.244 ms	0.244 ms
Programmer Service	0.4 ms + programmer time + 0.6 ms	0 ms	4.524 ms	2.454 ms
Non-Programmer Service	None in this example	0 ms	0 ms	0 ms
Reconfiguration	0.639 ms	0.639 ms	0.639 ms	0.638 ms
Diagnostics	0.048 ms	0.048 ms	0.048 ms	0.048 ms
PLC Sweep Time	Housekeeping + Data Input + Program Execution + Data Output + Programmer Service + Non-Programmer Service + Diagnostics	12.611 ms	17.135 ms	15.065 ms

### 1.1.3. Housekeeping

The housekeeping portion of the sweep performs all of the tasks necessary to prepare for the start of the sweep. If the PLC is in Constant Sweep mode, the sweep is delayed until the required sweep time elapses. If the required time has already elapsed, the OV\_SWP %SA0002 contact is set, and the sweep continues without delay. Next, timer values (hundredths, tenths, and seconds) are updated by calculating the difference from the start of the previous sweep and the new sweep time. In order not to lose accuracy, the actual start of sweep is recorded in 100 microsecond increments. Each timer has a remainder field which contains the number of 100 microsecond increments that have occurred since the last time the timer value was incremented.

### 1.1.4. Input Scan

Scanning of inputs occurs during the input scan portion of the sweep, just prior to the logic solution. During this part of the sweep, all Model 35 input modules are scanned and their data stored in %I (discrete inputs) or %AI (analog inputs) memory, as appropriate. Any global data received by an N80 Communications Module is stored in %G memory. The Alspa C80–25 and Micro input scan includes discrete inputs only.

Modules are scanned in ascending reference address order, starting with the N80 Communications Module, then discrete input modules, and finally analog input modules.

If the CPU is in STOP mode and the CPU is configured to not scan I/O in STOP mode, the input scan is skipped.

### 1.1.5. Application Program Logic Scan or Solution

The application program logic scan is when the application logic program actually executes. The logic solution always begins with the first instruction in the user application program immediately following the completion of the input scan. Solving the logic provides a new set of outputs. The logic solution ends when the END instruction is executed.

The application program is executed by the ISCP and the 80C188 microprocessor. In the Model 313 and higher CPUs, the ISCP executes the boolean instructions; and the 80C188 or 80386 EX executes the timer, counter, and function blocks. In the Model 311 and C80–25 CPUs, the 80C188 executes all boolean, timer, counter and function block instructions. On the Micro, the H8 processor executes all booleans and function blocks.

Many program control capabilities are provided by the control functions, described in chapter 4, § 9., *Control Functions*. A list of execution times for each programming function can be found in appendix A.

### 1.1.6. Output Scan

Outputs are scanned during the output scan portion of the sweep, immediately following the logic solution. Outputs are updated using data from %Q (for discrete outputs) and %AQ (for analog outputs) memory, as appropriate. If the N80 Communications Module is configured to transmit global data, then data from %G memory is sent to the NCM. The Alspa C80–25 and Micro output scans include discrete outputs only.

During the output scan, all Model 35 output modules are scanned in ascending reference address order.

If the CPU is in the STOP mode and the CPU is configured to not scan I/O during STOP mode, the output scan is skipped. The output scan is completed when all output data has been sent to all Model 35 output modules.

### 1.1.7. Logic Program Checksum Calculation

A checksum calculation is performed on the user program at the end of every sweep. Since it would take too long to calculate the checksum of the entire program, you can specify the number of words from 0 to 32 to be checksummed on the CPU detail screen. Refer to chapter 10 in the *ALS 52201 Alspa P8–25/35/05 Programming Software for Alspa C80–35, C80–25 and C80–05 PLCs User's Manual*.

If the calculated checksum does not match the reference checksum, the program checksum failure exception flag is raised. This causes a fault entry to be inserted into the PLC fault table and the PLC mode to be changed to STOP. If the checksum calculation fails, the programmer communications window is not affected.

## 1.2. Programmer Communications Window

This part of the sweep is dedicated to communicating with the programmer. If there is a programmer attached, the CPU executes the programmer communications window. The programmer communications window will not execute if there is no programmer attached and no board to be configured in the system. Only one board is configured each sweep.

Support is provided for the Hand-Held Programmer and for other programmers that can connect to the serial port and use the Serial Network Protocol (SNP) protocol. Support is also provided for programmer communications with intelligent option modules.

In the default limited window mode, the CPU performs one operation for the programmer each sweep, that is, it honors one service request or response to one key press. If the programmer makes a request that requires more than 6 milliseconds to process, the request processing is spread out over several sweeps so that no sweep is impacted by more than 6 milliseconds. The following figure is a flow chart for the programmer communications portion of the sweep.

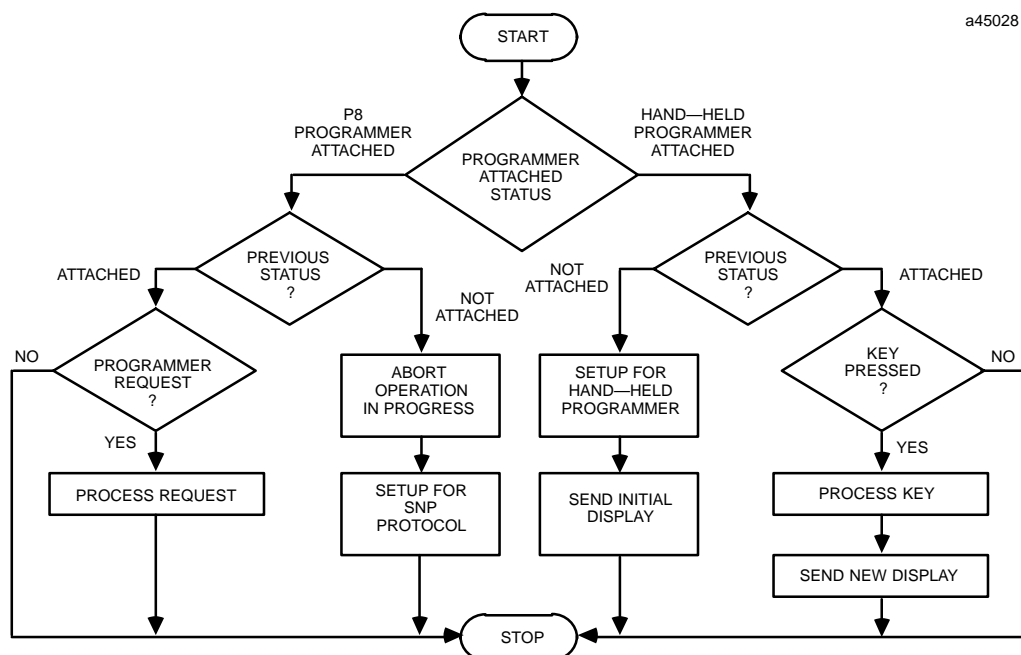

Figure 2.2 – Programmer Communications Window Flow Chart

### 1.3. System Communications Window (Models 331 and higher)

This is the part of the sweep where communications requests from intelligent option modules, such as the PCM, are processed (see flow chart). Requests are serviced on a first-come-first-served basis. However, since intelligent option modules are polled in a round-robin fashion, no intelligent option module has priority over any other intelligent option module.

In the default, **RUN-TO-COMPLETION** mode, the length of the system communications window is limited to 50 milliseconds when the PLC is in **STOP** mode. If an intelligent option module makes a request that requires more than 50 milliseconds to process, the request is spread out over multiple sweeps so that no one sweep is impacted by more than 50 milliseconds.

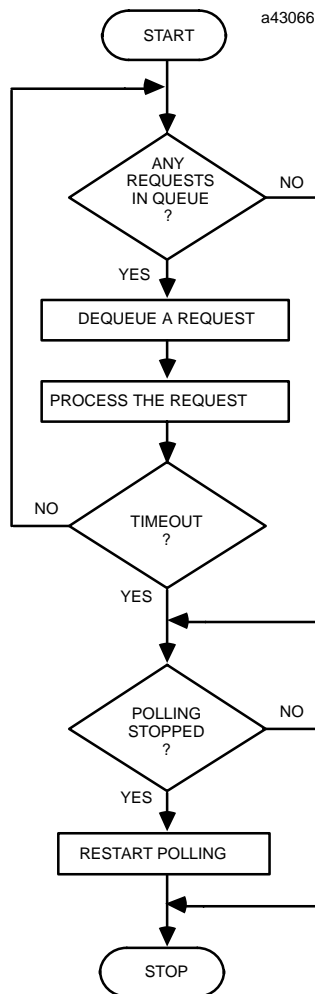

Figure 2.3 – System Communications Flow Chart

## 1.4. PCM Communications with the PLC (Model 331 and higher)

There is no way for intelligent option modules, such as the PCM, to interrupt the CPU when they need service. The CPU must poll each intelligent option module for service requests. This polling occurs asynchronously in the background during the sweep (see flow chart below).

When an intelligent option module is polled and sends the CPU a service request, the request is queued for processing during the system communications window.

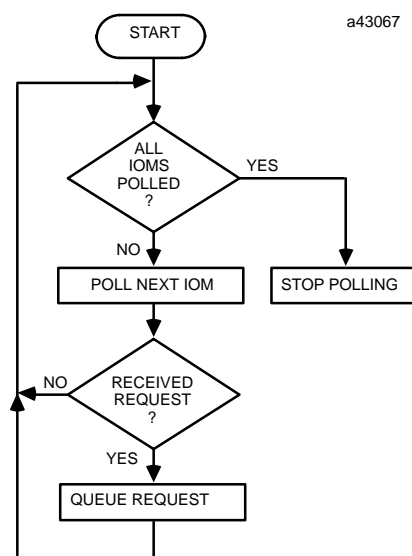

Figure 2.4 – PCM Communications with the PLC

## 1.5. Standard Program Sweep Variations

In addition to the normal execution of the standard program sweep, certain variations can be encountered or forced. These variations, described in the following paragraphs, can be displayed and/or changed from the PLC Control and Status menu in the Alspa P8–25/35/05 programming software or using the Hand–Held Programmer. For more information, refer to chapter 5, *PLC control and Status*, in the *ALS 52201 Alspa P8–25/35/05 Programming Software for Alspa C80–35, C80–25 and C80–05 PLCs User’s Manual*, or the *ALS 52202 Hand–Held Programmer for Alspa C80–35, C80–25 and C80–05 PLCs User’s Manual*.

### 1.5.1. Constant Sweep Time Mode

In the standard program sweep, each sweep executes as quickly as possible with a varying amount of time consumed each sweep. An alternative to this is the **CONSTANT SWEEP TIME** mode, where each sweep consumes the same amount of time. Use a constant sweep when I/O points or register values must be polled at a constant frequency, such as in control algorithms. You can achieve this by setting the Configured Constant Sweep, which will then become the default sweep mode, thereby taking effect each time the PLC goes from STOP to RUN mode. A value from 5 to 200 milliseconds can be selected (or up to 500 milliseconds for the 351 and 352 CPUs) for the constant sweep timer (default is 100 milliseconds).

Due to variations in the time required for various parts of the PLC sweep, the constant sweep time should be set at least 10 milliseconds higher than the sweep time that is displayed on the status line when the PLC is in **NORMAL SWEEP** mode. This prevents the occurrence of extraneous oversweep faults.

One reason for using **CONSTANT SWEEP TIME** mode might be to ensure that I/O are updated at constant intervals. Another reason might be to ensure that a certain amount of time elapses between the output scan and the next sweep's input scan, permitting inputs to settle after receiving output data from the program.

If the constant sweep timer expires before the sweep completes, the entire sweep, including the windows, is completed. However, an oversweep fault is logged at the beginning of the next sweep.

**Note**

Remember, unlike the **ACTIVE CONSTANT SWEEP** which can be edited only in **RUN** mode, the **CONFIGURED CONSTANT SWEEP** Mode can be edited only during **STOP** mode and you must "Store the configuration from the Programmer to the PLC" before the change will take effect. Once stored, this becomes the default sweep mode.

## 1.5.2. PLC Sweep When in STOP Mode

When the PLC is in **STOP** mode, the application program is not executed. You can choose whether or not the I/O is scanned. I/O scans may execute in **STOP** mode if the IOScan-Stop parameter on the CPU detail screen is set to YES. (Refer to chapter 10, in the *ALS 52201 Alspa P8-25/35/05 Programming Software for Alspa C80-35, C80-25 and C80-05 PLCs User's Manual*, for more information.) Communications with the programmer and intelligent option modules continue. In addition, faulted board polling and board reconfiguration execution continue while in **STOP** mode. For efficiency, the operating system uses larger time-slice values than those used in **RUN** mode (usually about 50 milliseconds per window).

## 1.6. Key Switch on 351/352 CPUs: Change Mode and Flash Protect

The 351 CPU has a key switch on the front of the module that allows you to protect Flash memory from being over-written. When you turn the key to the ON/RUN position, no one can change the Flash memory without turning the key to the OFF position.

Beginning with Release 7 of the 351 CPU and the 352 CPU, the same Key Switch has another function: it allows you to switch the PLC into STOP mode, into RUN mode and to clear non-fatal faults as discussed in the next section.

### 1.6.1. Using the Release 7 and Later Key Switch

Unlike the Flash Protection capabilities in the earlier release, if you do not enable the Key Switch through the RUN/STOP Key Switch parameter in the CPU's configuration screen, the CPU does not have the enhanced control discussed here (refer to chapter 10 § 3, "Configuring the CPU Module," in the *ALS 52201 Alspa P8-25/35/05 Programming Software for Alspa C80-35, C80-25 and C80-05 PLCs User's Manual*, for information on how to set that parameter).

The operation of the Key Switch has the same safeguards and checks before the PLC goes to RUN mode just like the existing transition to RUN mode; i.e., the PLC will not go to RUN mode via Key Switch input when the PLC is in STOP/FAULT mode. However, you can clear non-fatal faults and put the PLC in RUN mode through the use of Key Switch.

If there are faults in the fault tables that *are not fatal* (i.e., they do not cause the CPU to be placed in the STOP/FAULT mode), then the CPU will be placed in RUN mode the first time you turn the key from Stop to Run and the fault tables will NOT be cleared.

If there are faults in the fault table that *are fatal* (CPU in STOP/FAULT mode), then the first transition of the Key Switch from the STOP position to the RUN position will cause the CPU RUN light to begin to flash at 2 Hz rate and a 5 second timer will begin. The flashing RUN light is an indication that there are fatal fault(s) in the fault tables. In which case, the CPU will NOT be placed in the RUN state even though the Key Switch is in RUN position.

### 1.6.2. Clearing the Fault Table with the Key Switch

If you turn the key from the RUN to STOP and back to RUN position during the 5 seconds when the RUN light is flashing this will cause the faults to be cleared and the CPU will be placed into RUN mode. The light will stop flashing and will go solid ON at this point. The switch is required to be kept in either RUN or STOP position for at least 1/2 second before switching back to other position to take effect.

**Note**

If you allow the 5 second timer to expire (RUN light stops flashing) the CPU will remain in its original state, STOP/FAULT mode, with faults in the fault table. If you turn the Key Switch from the STOP to RUN position again at this time, the process will be repeated with this being the first transition.

The following table provides a summary of how the two CPU parameter settings affecting the Key Switch (R/S Switch and I/OScan-Stop) and the Key Switch's physical position affect PLC.

<b>R/S Key Switch Parameter in CPU Configuration</b>	<b>Key Switch Position</b>	<b>I/O Scan-Stop Parameter in CPU Configuration</b>	<b>PLC Operation</b>
OFF	X	X	All PLC Programmer Modes are allowed.
ON	ON/RUN	X	All PLC Programmer Modes are allowed.
ON	OFF/STOP	X	PLC not allowed to go to RUN.
ON	Toggle Key Switch from OFF/STOP to ON/RUN	X	PLC goes to RUN if no fatal faults are present otherwise, the RUN LED blinks for 5 seconds.
ON	Toggle Key Switch from ON/RUN to OFF/STOP	NO	PLC goes to STOP-NO IO
ON	Toggle Key Switch from ON/RUN to OFF/STOP	YES	PLC goes to STOP-IO

X=Has no effect regardless of setting

## 2. PROGRAM ORGANIZATION AND USER REFERENCES/DATA

The total logic size for the Alspa C80–35 programmable controller can be up to 6 KB in size for a Model 311 or Model 313 CPU, up to 16 KB in size for a Model 331 and up to 80 KB for Model 341 or Model 351 and 352 CPUs. A program for the Alspa C80–25 programmable controller can be up to 2 KB in size for a Model 211 CPU. A program for the Alspa 8000 Micro programmable controller can be up to 6 KB in size, up to 12 Kb for a 28 point C80–05 Micro PLC.

The user program contains logic that is used when it is started up. The maximum number of rungs allowed per logic block (main or subroutine) is 3000. The logic is executed repeatedly by the PLC.

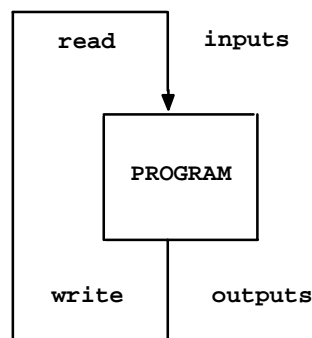

Refer to either the *ALS 52117 Alspa C80–35 PLC Installation Manual*, for a listing of program sizes and reference limits for each model CPU.

All programs begin with a variable declaration table. This table lists the nicknames and reference descriptions that have been assigned in the user program.

The block declaration editor lists subroutine blocks declared in the main program.

### 2.1. Subroutine Blocks (Alspa C80–35 PLC only)

A program can “call” subroutine blocks as it executes. A subroutine must be declared through the block declaration editor before a CALL instruction can be used for that subroutine. A maximum of 64 subroutine block declarations in the program and 64 CALL instructions are allowed for each logic block in the program. The maximum size of a subroutine block is 16K bytes or 3000 rungs, but the main program and all subroutines must fit within the logic size constraints for that CPU model.

#### Note

Subroutine blocks are not available for the Alspa C80–25 PLC nor for the Micro.

The use of subroutines is optional. Dividing a program into smaller subroutines can simplify programming and reduce the overall amount of logic needed for the program.

### 2.1.1. Examples of Using Subroutine Blocks

As an example, the logic for a program could be divided into three subroutines, each of which could be called as needed from the program. In this example, the program might contain little logic, serving primarily to sequence the subroutine blocks.

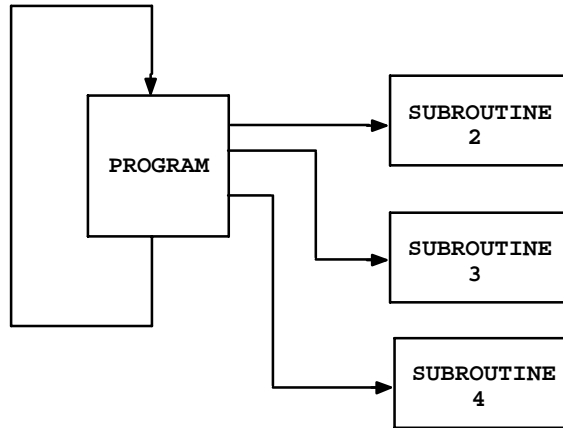

A subroutine block can be used many times as the program executes. Logic which needs to be repeated several times in a program could be entered in a subroutine block. Calls would then be made to that subroutine block to access the logic. In this way, total program size is reduced.

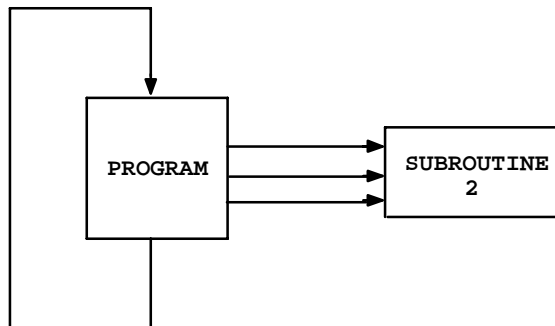

In addition to being called from the program, subroutine blocks can also be called by other subroutine blocks. A subroutine block may even call itself.

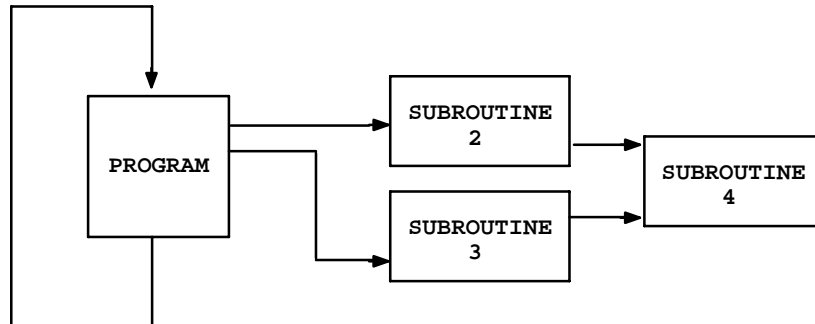

There is no limit to the number of levels of calls to subroutine blocks that Alspa P8 software will allow. However, the PLC will only allow eight nested calls before an “Application Stack Overflow” fault is logged and the PLC transitions to STOP/FAULT mode. The call level nesting counts the program as level 1.

### 2.1.2. How Subroutine Blocks are Called

A subroutine block executes when called from the program logic in the program or from another block.

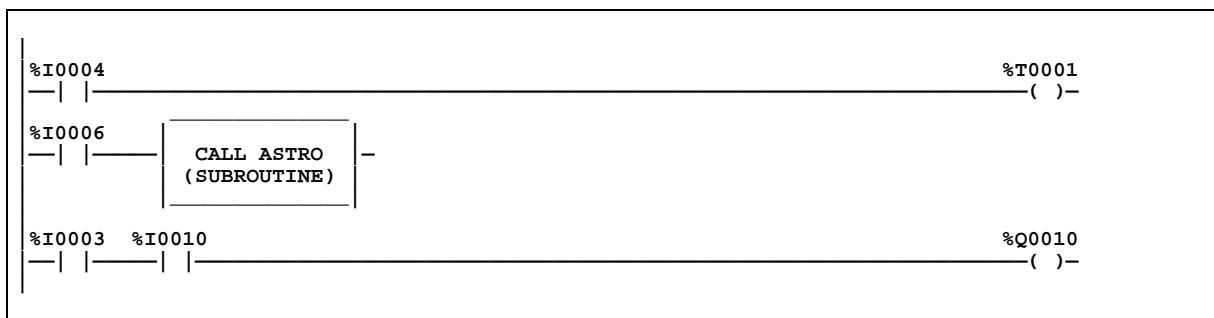

This example shows the subroutine CALL instruction as it will appear in the calling block. By positioning the cursor within the instruction, you can press F10 to zoom into the subroutine.

### 2.1.3. Periodic Subroutines

Version 4.20 or later of the 340 and higher CPUs support periodic subroutines — see chapter 3, “Subroutine Blocks” of the *ALS 52201 Alspa P8–25/35/05 Programming Software for Alspa C80–35, C80–25 and C80–05 PLCs User’s Manual*. Please note the following restrictions:

1. Time (TMR, ONDTR, and OFDTR) function blocks will not execute properly within a periodic subroutine. A DOIO function block within a periodic subroutine whose reference range includes references assigned to a Smart I/O Module (HSC, APM, NBC, etc.) will cause the CPU to lose communication with the module. The FST\_SCN and LST\_SCN contacts (%S1 and %S2) will have an indeterminate value during execution of the periodic subroutine. A periodic subroutine cannot call or be called by other subroutines.
2. The latency for the periodic subroutine (i.e., the maximum interval between the time the periodic subroutine should have executed and the time it actually executes) can be around 0.35 milliseconds if there is no PCM, CMM, or ADC module in the main rack. If there is a PCM, CMM or ADC module in the main rack — even if it is not configured or used — the latency can be almost 2.25 milliseconds. For that reason, use of the periodic subroutine with PCM-based products is *not* recommended.

## 2.2. User References

The data used in an application program is stored as either register or discrete references.

**Table 2.5 – Register References**

Type	Description
%R	The prefix %R is used to assign system register references, which will store program data such as the results of calculations.
%AI	The prefix %AI represents an analog input register. This prefix is followed by the register address of the reference (e.g., %AI0015). An analog input register holds the value of one analog input or other value.
%AQ	The prefix %AQ represents an analog output register. This prefix is followed by the register address of the reference (e.g., %AQ0056). An analog output register holds the value of one analog output or other value.

**Note**

All register references are retained across a power cycle to the CPU.

Table 2.6 – Discrete References

Type	Description
%I	<p>The %I prefix represents input references. This prefix is followed by the reference's address in the input table (e.g., %I00121). %I references are located in the input status table, which stores the state of all inputs received from input modules during the last input scan.</p> <p>A reference address is assigned to discrete input modules using the configuration software or the Hand-Held Programmer. Until a reference address is assigned, no data will be received from the module.</p>
%Q	<p>The %Q prefix represents physical output references. The coil check function of Alspa P8–25/35/05 software checks for multiple uses of %Q references with relay coils or outputs on functions. You can select the level of coil checking desired (SINGLE, WARN MULTIPLE, or MULTIPLE). Refer to the <i>ALS 52201 Alspa P8–25/35/05 Programming Software for Alspa C80–35, C80–25 and C80–05 PLCs User's Manual</i>, for more information about this feature.</p> <p>The %Q prefix is followed by the reference's address in the output table (e.g., %Q00016). %Q references are located in the output status table, which stores the state of the output references as last set by the application program. This output status table's values are sent to output modules at the end of the program scan.</p> <p>A reference address is assigned to discrete output modules using the configuration software or the Hand-Held Programmer. Until a reference address is assigned, no data is sent to the module. A particular %Q reference may be either retentive or non-retentive. *</p>
%M	<p>The %M prefix represents internal references. The coil check function of Alspa P8–25/35/05 software checks for multiple uses of %M references with relay coils or outputs on functions. You can select the level of coil checking desired (SINGLE, WARN MULTIPLE, or MULTIPLE). Refer to the <i>ALS 52201 Alspa P8–25/35/05 Programming Software for Alspa C80–35, C80–25 and C80–05 PLCs User's Manual</i>, for more information about this feature. A particular %M reference may be either retentive or non-retentive. *</p>
%T	<p>The %T prefix represents temporary references. These references are never checked for multiple coil use and can, therefore, be used many times in the same program even when coil use checking is enabled. %T may be used to prevent coil use conflicts while using the cut/paste and file write/include functions.</p> <p>Because this memory is intended for temporary use, it is never retained through power loss or <b>RUN</b>–to–<b>STOP</b>–to–<b>RUN</b> transitions and cannot be used with retentive coils.</p>
%S	<p>The %S prefix represents system status references. These references are used to access special PLC data, such as timers, scan information, and fault information. System references include %S, %SA, %SB, and %SC references.</p> <p>%S, %SA, %SB, and %SC can be used on any contacts.</p> <p>%SA, %SB, and %SC can be used on retentive coils —(M)—.</p> <p>%S can be used as word or bit-string input arguments to functions or function blocks.</p> <p>%SA, %SB, and %SC can be used as word or bit-string input or output arguments to functions and function blocks.</p>
%G	<p>The %G prefix represents global data references. These references are used to access data shared among several PLCs. %G references can be used on contacts and retentive coils because %G memory is always retentive. %G cannot be used on non-retentive coils.</p>

\* Retentiveness is based on the type of coil. For more information, refer to “Retentiveness of Data” on page 2–20.

## 2.3. Transitions and Overrides

The %I, %Q, %M, and %G user references have associated transition and override bits. %T, %S, %SA, %SB, and %SC references have transition bits, but not override bits. The CPU uses transition bits for counters and transitional coils. Note that counters do not use the same kind of transition bits as coils. Transition bits for counters are stored within the locating reference.

In the Model 331 and higher, override bits can be set. When override bits are set, the associated references cannot be changed from the program or the input device; they can only be changed on command from the programmer. CPU Models 323, 321, 313, 311, 211 and the Micro CPUs do not support overriding discrete references.

## 2.4. Retentiveness of Data

Data is said to be retentive if it is saved by the PLC when the PLC is stopped. The Alspa 8000 PLC preserves program logic, fault tables and diagnostics, overrides and output forces, word data (%R, %AI, %AQ), bit data (%I, %SC, %G, fault bits and reserved bits), %Q and %M data (unless used with non-retentive coils), and word data stored in %Q and %M. %T data is not saved. Although, as stated above, %SC bit data is retentive, %S, %SA and %SB are non-retentive.

%Q and %M references are non-retentive (i.e., cleared at power-up when the PLC switches from STOP to RUN) whenever they are used with non-retentive coils. Non-retentive coils include coils —( )—, negated coils —(/)—, SET coils —(S)— and RESET coils —(R)—.





When %Q or %M references are used with retentive coils, or are used as function block outputs, the contents are retained through power loss and **RUN**-to-**STOP**-to-**RUN** transitions. Retentive coils include retentive coils —(M)—, negated retentive coils —(/M)—, retentive SET coils —(SM)— and retentive RESET coils —(RM)—.

The last time a %Q or %M reference is programmed on a coil instruction determines whether the %Q or %M reference is retentive or non-retentive based on the coil type. For example, if %Q0001 was last programmed as the reference of a retentive coil, the %Q0001 data will be retentive. However, if %Q0001 was last programmed on a non-retentive coil, then the %Q0001 data will be non-retentive.

## 2.5. Data Types

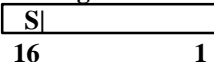
Data types include the following:

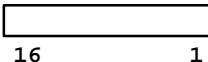
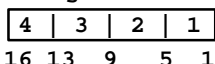
**Table 2.7 – Data Types**

Type	Name	Description	Data Format
INT	Signed Integer	Signed integers use 16-bit memory data locations, and are represented in 2's complement notation. The valid range of an INT data type is $-32,768$ to $+32,767$ .	<p><b>Register 1</b></p>  <p>(16 bit positions)</p>
DINT	Double Precision Signed Integer	Double precision signed integers are stored in 32-bit data memory locations (actually two consecutive 16-bit memory locations) and represented in 2's complement notation. (Bit 32 is the sign bit.) The valid range of a DINT data type is $-2,147,483,648$ to $+2,147,483,867$ .	<p><b>Register 2</b>                      <b>Register 1</b></p>  <p>(Two's Complement Value)</p>
BIT	Bit	A Bit data type is the smallest unit of memory. It has two states, 1 or 0. A BIT string may have length N.	
BYTE	Byte	A Byte data type has an 8-bit value. The valid range is 0 to 255 (0 to FF in hexadecimal).	
WORD		A Word data type uses 16 consecutive bits of data memory; but, instead of the bits in the data location representing a number, the bits are independent of each other. Each bit represents its own binary state (1 or 0), and the bits are not looked at together to represent an integer number. The valid range of word values is 0 to FFFF.	<p><b>Register 1</b></p>  <p>(16 bit positions)</p>
BCD-4	Four-Digit Binary Coded Decimal	Four-digit BCD numbers use 16-bit data memory locations. Each BCD digit uses four bits and can represent numbers between 0 and 9. This BCD coding of the 16 bits has a legal value range of 0 to 9999.	<p><b>Register 1</b></p>  <p>(4 BCD digits)</p>
REAL	Floating-Point	Real numbers use 32 consecutive bits (actually two consecutive 16-bit memory locations). The range of numbers that can be stored in this format is from $\pm 1.401298E-45$ to $\pm 3.402823E+38$ . Refer to Appendix E, "Using Floating-Point Numbers," for IEEE format.	<p><b>Register 2</b>                      <b>Register 1</b></p>  <p>(Two's Complement Value)</p>

S = Sign bit (0 = positive, 1 = negative).

## 2.6. System Status References

System status references in the Alspa 8000 PLC are assigned to %S, %SA, %SB, and %SC memory. They each have a nickname. Examples of time tick references include T\_10MS, T\_100MS, T\_SEC and T\_MIN. Examples of convenience references include FST\_SCN, ALW\_ON and ALW\_OFF.

**Note**

%S bits are read-only bits; do not write to these bits. You may, however, write to %SA, %SB and %SC bits.

Listed below are available system status references, which may be used in an application program. When entering logic, either the reference or the nickname can be used. Refer to chapter 3, *Fault Explanations and Correction*, for more detailed fault descriptions and information on correcting the fault.

It is possible to use these special names in another context. However, if you attempt to use one of these names for some other use (e.g., logic block name, folder name, etc.), the Alspa P8-25/35/05 software displays this prompt:

**Reuse system reserved nickname \_\_\_\_\_ ? (Y/N)**

**Note**

References not listed in the following table are not used for the Alspa C80-35 or Alspa C80-25 PLC.

**Table 2.8 – System Status References**

Reference	Nickname	Definition
%S0001	FST_SCN	Set to 1 when the current sweep is the first sweep.
%S0002	LST_SCN	Reset from 1 to 0 when the current sweep is the last sweep.
%S0003	T_10MS	0.01 second timer contact.
%S0004	T_100MS	0.1 second timer contact.
%S0005	T_SEC	1.0 second timer contact.
%S0006	T_MIN	1.0 minute timer contact.
%S0007	ALW_ON	Always ON.
%S0008	ALW_OFF	Always OFF.
%S0009	SY_FULL	Set when the PLC fault table fills up. Cleared when an entry is removed from the PLC fault table and when the PLC fault table is cleared.
%S0010	IO_FULL	Set when the I/O fault table fills up. Cleared when an entry is removed from the I/O fault table and when the I/O fault table is cleared.
%S0011	OVR_PRE	Set when an override exists in %I, %Q, %M, or %G memory.
%S0013	PRG_CHK	Set when background program check is active.
%S0014	PLC_BAT	Set to indicate a bad battery in a Release 4 or later CPU. The contact reference is updated once per sweep.
%S0017	SNPXACT	SNP-X host is actively attached to the CPU.
%S0018	SNPX_RD	SNP-X host has read data from the CPU.
%S0019	SNPX_WT	SNP-X host has written data to the CPU.
%S0020		Set ON when a relational function using REAL data executes successfully. It is cleared when either input is NaN (Not a Number).
%S0032		Reserved for use by the Alspa P8-25/35/05 software.

**Table 2.8 – System Status References – Continued**

Reference	Nickname	Definition
%SA0001	PB_SUM	Set when a checksum calculated on the application program does not match the reference checksum. If the fault was due to a temporary failure, the discrete bit can be cleared by again storing the program to the CPU. If the fault was due to a hard RAM failure, the CPU must be replaced.
%SA0002	OV_SWP	Set when the PLC detects that the previous sweep took longer than the time specified by the user. Cleared when the PLC detects that the previous sweep did not take longer than the specified time. It is also cleared during the transition from STOP to RUN mode. Only valid if the PLC is in Constant Sweep mode.
%SA0003	APL_FLT	Set when an application fault occurs. Cleared when the PLC transitions from STOP to RUN mode.
%SA0009	CFG_MM	Set when a configuration mismatch is detected during system power-up or during a store of the configuration. Cleared by powering up the PLC when no mismatches are present or during a store of configuration that matches hardware.
%SA0010	HRD_CPU	Set when the diagnostics detects a problem with the CPU hardware. Cleared by replacing the CPU module.
%SA0011	LOW_BAT	Set when a low battery fault occurs. Cleared by replacing the battery and ensuring that the PLC powers up without the low battery condition.
%SA0014	LOS_IOM	Set when an I/O module stops communicating with the PLC CPU. Cleared by replacing the module and cycling power on the main rack.
%SA0015	LOS_SIO	Set when an option module stops communicating with the PLC CPU. Cleared by replacing the module and cycling power on the main rack.
%SA0019	ADD_IOM	Set when an I/O module is added to a rack. Cleared by cycling power on the main rack and when the configuration matches the hardware after a store.
%SA0020	ADD_SIO	Set when an option module is added to a rack. Cleared by cycling power on the main rack and when the configuration matches the hardware after a store.
%SA0027	HRD_SIO	Set when a hardware failure is detected in an option module. Cleared by replacing the module and cycling power on the main rack.
%SA0031	SFT_SIO	Set when an unrecoverable software fault is detected in an option module. Cleared by cycling power on the main rack and when the configuration matches the hardware.
%SB0010	BAD_RAM	Set when the CPU detects corrupted RAM memory at power-up. Cleared when the CPU detects that RAM memory is valid at power-up.
%SB0011	BAD_PWD	Set when a password access violation occurs. Cleared when the PLC fault table is cleared.
%SB0013	SFT_CPU	Set when the CPU detects an unrecoverable error in the software. Cleared by clearing the PLC fault table.
%SB0014	STOR_ER	Set when an error occurs during a programmer store operation. Cleared when a store operation is completed successfully.
%SC0009	ANY_FLT	Set when any fault occurs. Cleared when both fault tables have no entries.
%SC0010	SY_FLT	Set when any fault occurs that causes an entry to be placed in the PLC fault table. Cleared when the PLC fault table has no entries.
%SC0011	IO_FLT	Set when any fault occurs that causes an entry to be placed in the I/O fault table. Cleared when the I/O fault table has no entries.
%SC0012	SY_PRES	Set as long as there is at least one entry in the PLC fault table. Cleared when the PLC fault table has no entries.
%SC0013	IO_PRES	Set as long as there is at least one entry in the I/O fault table. Cleared when the I/O fault table has no entries.
%SC0014	HRD_FLT	Set when a hardware fault occurs. Cleared when both fault tables have no entries.
%SC0015	SFT_FLT	Set when a software fault occurs. Cleared when both fault tables have no entries.

## 2.7. Function Block Structure

Each rung of logic is composed of one or more programming instructions. These may be simple relays or more complex functions.

### 2.7.1. Format of Ladder Logic Relays

The Alspa P8-25/35/05 software includes several types of relay functions. These functions provide basic flow and control of logic in the program. Examples include a normally open relay contact (—| |—) and a negated coil (—(/)—). Each of these relay contacts and coils has one input and one output. Together, they provide logic flow through the contact or coil.

Each relay contact or coil must be given a reference which is entered when selecting the relay. For a contact, the reference represents a location in memory that determines the flow of power into the contact. In the following example, if reference %I0122 is ON, power will flow through this relay contact

```
%I0122
—| |—
```

For a coil, the reference represents a location in memory that is controlled by the flow of power into the coil. In this example, if power flows into the left side of the coil, reference %Q0004 is turned ON

```
%Q0004
—( )—
```

Alspa P8-25/35/05 software and the Hand-Held Programmer both have a coil check function that checks for multiple uses of %Q or %M references with relay coils or outputs on functions. You can select the level of coil checking desired (SINGLE, WARN MULTIPLE, or MULTIPLE). Refer to the *ALS 52201 Alspa P8-25/35/05 Programming Software for Alspa C80-35, C80-25 and C80-05 PLCs User's Manual*, or the *ALS 52202 Hand-Held Programmer for Alspa C80-35, C80-25 and C80-05 PLCs User's Manual*, for more information about this feature.

### 2.7.2. Format of Program Function Blocks

Some functions are very simple, like the MCR function, which is shown with the abbreviated name of the function within brackets:

```
—[ MCR ]—
```

Other functions are more complex. They may have several places where you will enter information to be used by the function.

The function block illustrated below is multiplication (MUL). Its parts are typical of many Alspa P8-25/35/05 program functions. The upper part of the function block shows the name of the function. It may also show a data type; in this case, signed integer.

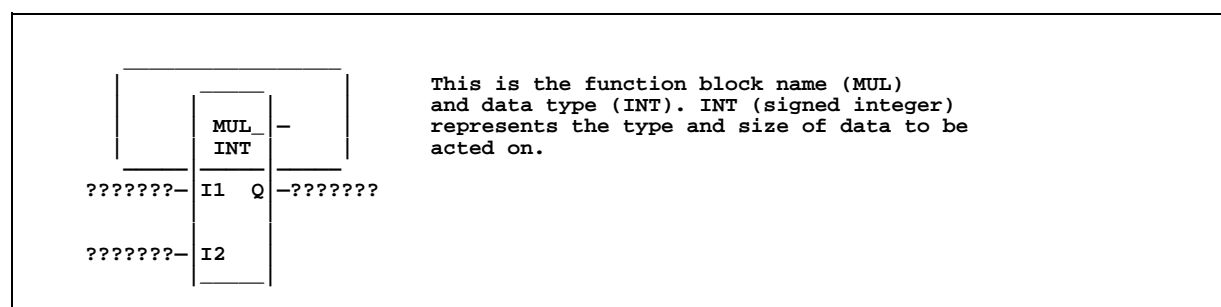

Many program functions allow you to select the data type for the function after selecting the function. For example, the data type for the MUL function could be changed to double precision signed integer. Additional information on data types is provided earlier in this chapter.

### 2.7.3. Function Block Parameters

Each line entering the left side of a function block represents an input for that function. There are two forms of input that can be passed into a function block; they are constants and references. A constant is an explicit value. A reference is the address of a value.

In the following example, input parameter I1 comes into the ADD function block as a constant, and input parameter I2 comes in as a reference.

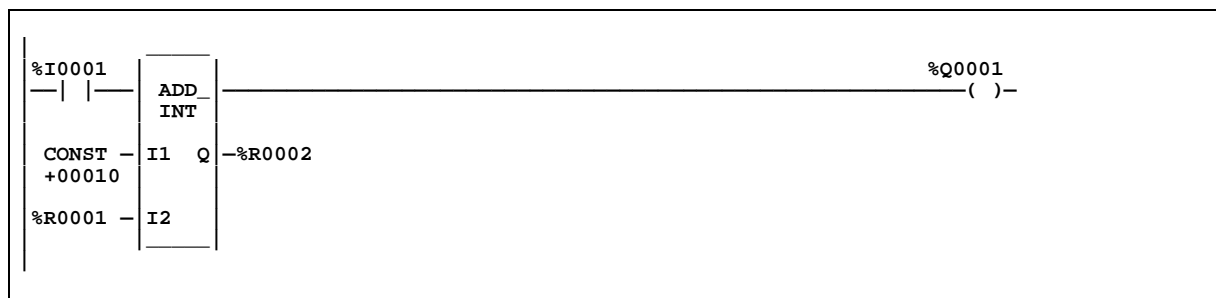

Each line exiting the right side of the function block represents an output. There is only one form of output from a function block or reference. Outputs can never be written to constants.

Where the question marks appear on the left of a function block, you will enter either the data itself or a reference location where the data is found. Where question marks appear on the right of a function block, you will usually enter a reference location for data to be output by the function block.

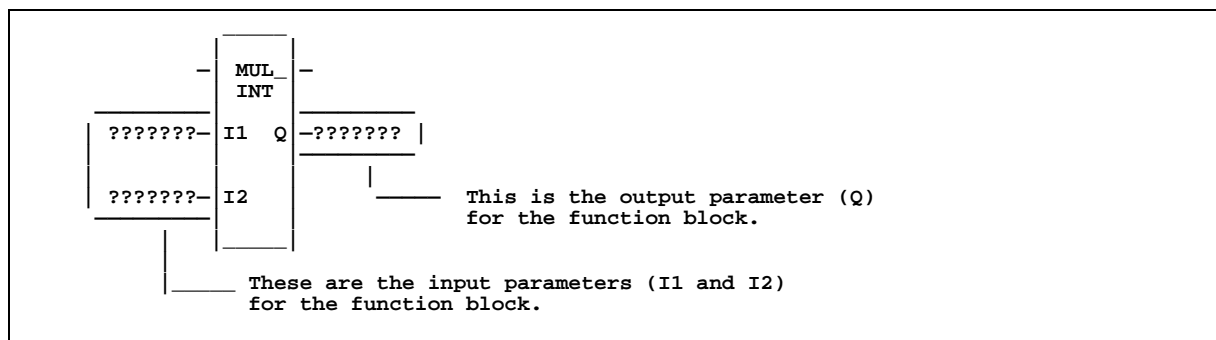

Most function blocks do not change input data; instead, they place the result of the operation in an output reference.

For functions which operate on tables, a length can be selected for the function.

Timer, counter, BITSEQ and ID functions require an address for the location of three words (registers) which store the current value, preset value and a control word of the function. This locating reference is located directly below the function block, as shown below.

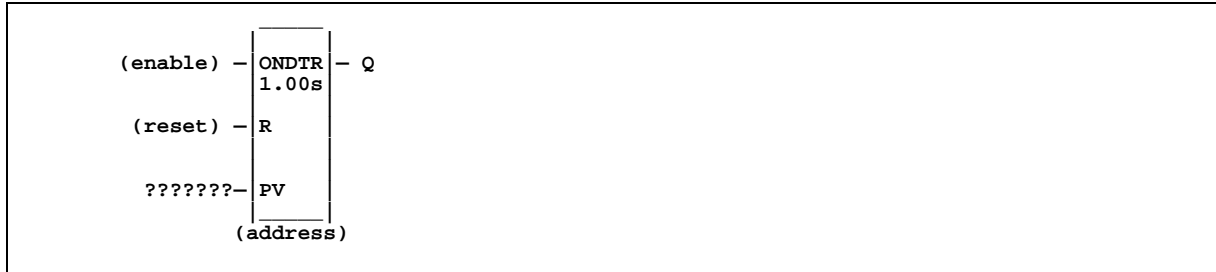

For more information on function block data required for timers and counters, please refer to chapter 4, § 2., *Timers and Counters*.

### 2.7.4. Power Flow In and Out of a Function

Power flows into a function block on the upper left. Often, enabling logic is used to control power flow to a function block; otherwise, the function block executes unconditionally each CPU sweep.

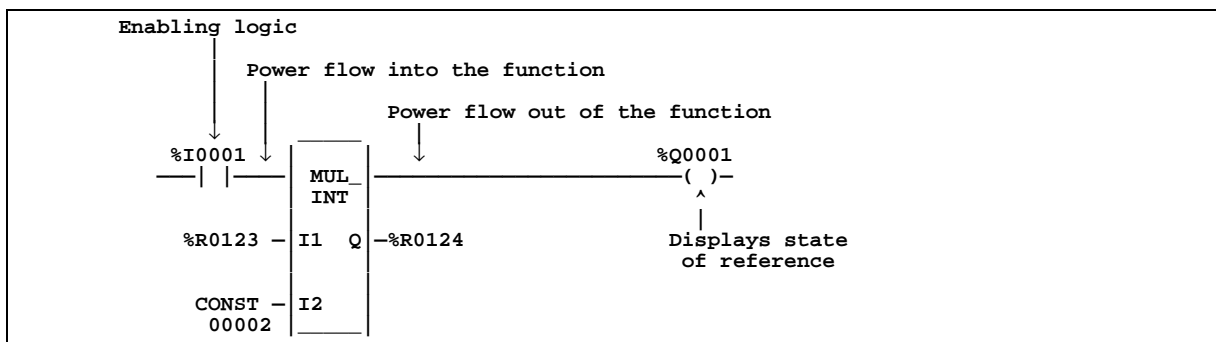

Power flows out of the function block on the upper right. It may be passed to other program logic or to a coil (optional). Function blocks pass power when they execute successfully. Each function's description in this book explains the conditions under which it passes power flow to the right.

**Note**

Function blocks cannot be tied directly to the left power rail. You can use %S7, the ALL\_ON (always on) bit with a normally open contact tied to the power rail to call a function every sweep.

### 3. POWER-UP AND POWER-DOWN SEQUENCES

There are two possible power-up sequences in the Alspa C80-35 PLC; a cold power-up and a warm power-up. The CPU normally uses the cold power-up sequence. However, in a Model 331 or higher PLC system, if the time that elapses between a power-down and the next power-up is less than five seconds, the warm power-up sequence is used.

#### 3.1. Power-Up

A cold power-up consists of the following sequence of events.

**Note**

A warm power-up sequence is the same, except that step 1 is skipped.

1. The CPU will run diagnostics on itself. This includes checking a portion of battery-backed RAM to determine whether or not the RAM contains valid data.
2. If an EPROM, EEPROM or flash memory is present and the PROM power-up option in the PROM specifies that the PROM contents should be used, the contents of PROM are copied into RAM memory. If an EPROM, EEPROM or flash memory is not present, RAM memory remains the same and is not overwritten with the contents of PROM.
3. The CPU interrogates each slot in the system to determine which boards are present.
4. The hardware configuration is compared with software configuration to ensure that they are the same. Any mismatches detected are considered faults and are alarmed. Also, if a board is specified in the software configuration but a different module is present in the actual hardware configuration, this condition is a fault and is alarmed.
5. If there is no software configuration, the CPU will use the default configuration.
6. The CPU establishes the communications channel between itself and any intelligent modules.
7. In the final step of the execution, the mode of the first sweep is determined based on CPU configuration. If **RUN** mode, the sweep proceeds as described under “**STOP**-to-**RUN** Mode Transition.” Figure 2.5 on the next page shows the decision sequence for the CPU when it decides whether to copy from PROM or to power-up in **STOP** or **RUN** mode.

**Notes**

1. Steps 2 through 6 above do not apply to the C80-05 Micro PLC. For information about the power-up and power-down sequences for the Micro, refer to the “Power-up and Power-down Sequences” of Chapter 5, in the *ALS 52119 Alspa C80-05 Micro PLC User's Manual*.
2. The first part of this chart on the Figure 2.5 does not apply to the C80-05 Micro PLC. For information about the power-up and power-down sequences for the Micro, refer to the “Power-up and Power-down Sequences” of Chapter 5, *ALS 52119 Alspa C80-05 Micro PLC User's Manual*.

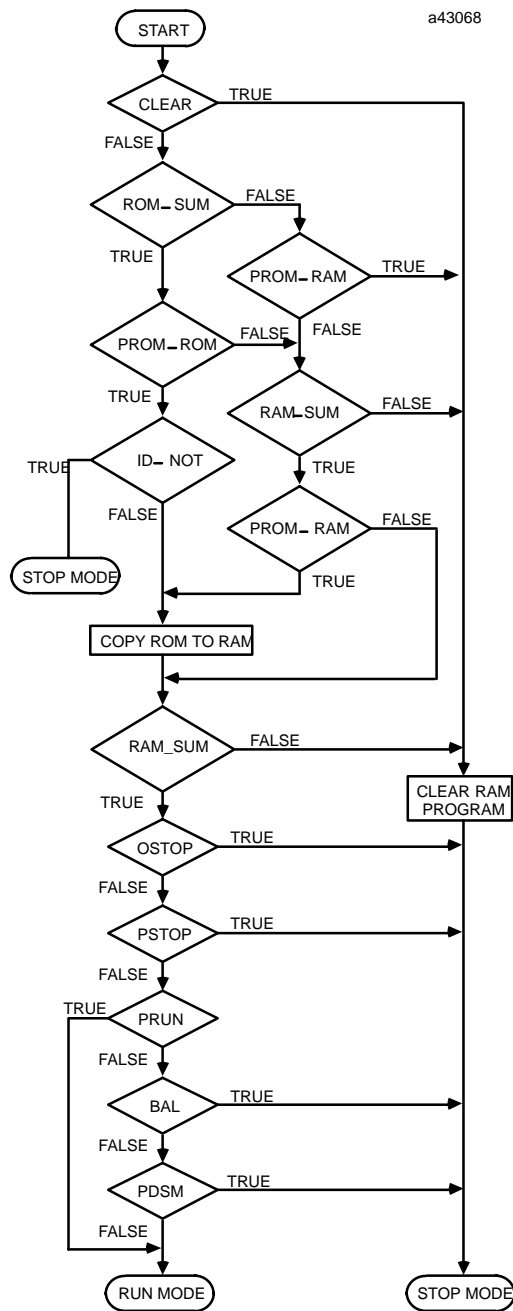

**Figure 2.5 – Power-Up Sequence**

- |            |                                    |        |                                    |
|------------|------------------------------------|--------|------------------------------------|
| clear      | = Press CLR] and M/T] (using HHP). | Id_not | = Press LD] and NOT] (using HHP).  |
| rom_sum *  | = ROM checksum is good.            | ostop  | = Press NOT] and RUN] (using HHP). |
| prom_rom   | = Run from ROM (parameter in ROM). | pstop  | = Power up in STOP mode.           |
| ram_sum    | = RAM checksum is good.            | prun   | = Power up in RUN mode.            |
| prom_ram * | = Run from ROM (parameter in RAM). | bal    | = Battery voltage is low.          |
|            |                                    | pdsm   | = power down in STOP mode.         |

\* If a PROM is not present, rom\_sum = false and prom\_ram = false.

## 3.2. Power-Down

System power-down occurs when the power supply detects that incoming AC power has dropped for more than one power cycle or the output of the 5-volt power supply has fallen to less than 4.9 volts DC.

## 4. CLOCKS AND TIMERS

Clocks and timers provided by the Alspa C80-35 PLC include an elapsed time clock, a time-of-day clock (Model 331, 341, 351/352 and 28-point C80-05 Micro) a watchdog timer, and a constant sweep timer. Two types of timer function blocks include an on-delay timer and a start-reset timer. Four time-tick contacts cycle on and off for 0.01 second, 0.1 second, 1.0 second and 1 minute intervals.

### 4.1. Elapsed Time Clock

The elapsed time clock uses 100 microsecond “ticks” to track the time elapsed since the CPU powered on. The clock is not retentive across a power failure; it restarts on each power-up. Once per second the hardware interrupts the CPU to enable a seconds count to be recorded. This seconds count rolls over approximately 100 years after the clock begins timing.

Because the elapsed time clock provides the base for system software operations and timer function blocks, it may not be reset from the user program or the programmer. However, the application program can read the current value of the elapsed time clock by using SVCREQ function No. 16, described in chapter 4, § 9., *Control Functions*.

### 4.2. Time-of-Day Clock (Model 331 and Model 340/341)

The time of day in the 28 point C80-05 Micro and Alspa C80-35 PLC Model 331 and higher is maintained by a hardware time-of-day clock. The time-of-day clock maintains seven time functions:

- Year (two digits).
- Month.
- Day of month.
- Hour.
- Minute.
- Second.
- Day of week.

The time-of-day clock is battery-backed and maintains its present state across a power failure. However, unless you initialize the clock, the values it contains are meaningless. The application program can read and set the time-of-day clock using SVCREQ function No. 7. The time-of-day clock can also be read and set from the CPU Configuration menu in the configuration software package. (Refer to chapter 11, *CPU Configuration*, in the *ALS 52201 Alspa P8-25/35/05 Programming Software for Alspa C80-35, C80-25 and C80-05 PLCs User's Manual*.)

The time-of-day clock is designed to handle month-to-month and year-to-year transitions. It automatically compensates for leap years until the year 2079.

### 4.3. Watchdog Timer

A watchdog timer in the Alspa C80–35 PLC is designed to catch catastrophic failure conditions that result in an unusually long sweep. The timer value for the watchdog timer is 200 milliseconds (500 milliseconds in 351); this is a fixed value which cannot be changed. The watchdog timer always starts from zero at the beginning of each sweep.

If the watchdog timeout value is exceeded, the OK LED goes off; the CPU is placed in reset and completely shuts down; and outputs go to their default state. No communication of any form is possible, and all microprocessors on all boards are halted. To recover, power must be cycled on the rack containing the CPU.

In the Alspa C80–25, and 340 and higher CPUs, a watchdog timer causes the CPU to reset, execute its powerup logic, generate a watchdog failure fault, and change its mode to **STOP**.

### 4.4. Constant Sweep Timer

The constant sweep timer controls the length of a program sweep when the Alspa C80–35 PLC operates in Constant Sweep Time mode. In this mode of operation, each sweep consumes the same amount of time. Typically, for most application programs, the input scan, application program logic scan, and output scan do not require exactly the same amount of execution time in each sweep. The value of the constant sweep timer is set by the programmer and can be any value from 5 to the value of the watchdog timer (default is 100 milliseconds).

If the constant sweep timer expires before the completion of the sweep and the previous sweep was not oversweep, the PLC places an oversweep alarm in the PLC fault table. At the beginning of the next sweep, the PLC sets the OV\_SWP fault contact. The OV\_SWP contact is reset when the PLC is not in Constant Sweep Time mode or the time of the last sweep did not exceed the constant sweep timer.

### 4.5. Time–Tick Contacts

The Alspa 8000 PLC provides four time–tick contacts with time durations of 0.01 second, 0.1 second, 1.0 second, and 1 minute. The state of these contacts does not change during the execution of the sweep. These contacts provide a pulse having an equal on and off time duration. The contacts are referenced as T\_10MS (0.01 second), T\_100MS (0.1 second), T\_SEC (1.0 second) and T\_MIN (1 minute).

The following timing diagram represents the on/off time duration of these contacts.

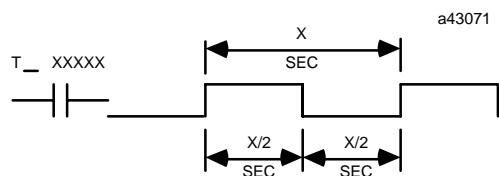

Figure 2.6 – Time–Tick Contact Timing Diagram

## 5. SYSTEM SECURITY

Security in the Alspa C80–35 and Alspa C80–25 PLCs is designed to prevent unauthorized changes to the contents of a PLC. There are four security levels available in the PLC. The first level, which is always available, provides only the ability to read PLC data; no changes are permitted to the application. The other three levels have access to each level protected by a password. The information in this paragraph is also applicable to the Alspac C80–05 Micro PLC.

Each higher privilege level permits greater change capabilities than the lower level(s). Privilege levels accumulate in that the privileges granted at one level are a combination of that level, plus all lower levels. The levels and their privileges are:

Privilege Level	Description
Level 1	Any data, except passwords may be read. This includes all data memories (%I, %Q, %AQ, %R, etc), fault tables, and all program block types (data, value and constant). No values may be changed in the PLC.
Level 2	This level allows write access to the data memories (%I, %R, etc).
Level 3	This level allows write access to the application program in <b>STOP</b> mode only.
Level 4	This is the default level for systems which have no passwords set. The default level for a system with passwords is to the highest unprotected level. This level, the highest, allows read and write access to all memories as well as passwords in both <b>RUN</b> and <b>STOP</b> mode. (Configuration data cannot be changed in <b>RUN</b> mode.)

### 5.1. Passwords

There is one password for each privilege level in the PLC. (No password can be set for level 1 access.) Each password may be unique; however, the same password can be used for more than one level. Passwords are one to four ASCII characters in length; they can only be entered or changed with the Alspa P8–25/35/05 software or the Hand–Held Programmer.

A privilege level change is in effect only as long as communications between the PLC and the programmer are intact. There does not need to be any activity, but the communications link must not be broken. If there is no communication for 15 minutes, the privilege level returns to the highest unprotected level.

Upon connection of the PLC, the Alspa P8–25/35/05 programmer requests the protection status of each privilege level from the PLC. The Alspa P8–25/35/05 programmer then requests the PLC to move to the highest unprotected level, thereby giving the programmer access to the highest unprotected level without having to request any particular level. When the Hand–Held Programmer is connected to the PLC, the PLC reverts to the highest unprotected level.

## 5.2. Privilege Level Change Requests

A programmer requests a privilege level change by supplying the new privilege level and the password for that level. A privilege level change is denied if the password sent by the programmer does not agree with the password stored in the PLC's password access table for the requested level. The current privilege level is maintained and no change will occur. If you attempt to access or modify information in the PLC using the Hand-Held Programmer without the proper privilege level, the Hand-Held Programmer will respond with an error message that the access is denied.

For an explanation of how to set passwords and change the password privilege level, refer to chapter 5, *PLC Control and Status* in the *ALS 52201 Alspa P8-25/35/05 Programming Software for Alspa C80-35, C80-25 and C80-05 PLCs User's Manual*.

## 5.3. Locking/Unlocking Subroutines

Subroutine blocks can be locked and unlocked using the block locking feature of Alspa P8-25/35/05 software, as described in the *ALS 52201 Alspa P8-25/35/05 Programming Software for Alspa C80-35, C80-25 and C80-05 PLCs User's Manual*. Two types of locks are available:

Type of Lock	Description
View	Once locked, you cannot zoom into that subroutine.
Edit	Once locked, the information in the subroutine cannot be edited.

A previously view locked or edit locked subroutine may be unlocked in the block declaration editor unless it is permanently view locked or permanently edit locked.

The display zoom level function (ALT-X) can be used to display the lock status of the subroutine in the block declaration editor. Move the cursor to the desired block, and press ALT-X.

A search or search and replace function may be performed on a view locked subroutine. If the target of the search is found in a view locked subroutine, one of the following messages is displayed, instead of logic:

**Found in locked block <block\_name> (Continue/Quit)**

or

**Cannot write to locked block <block\_name> (Continue/Quit)**

You may continue or abort the search. For more information on search and search/replace, please refer to chapter 3, *Program Editing*, in the *ALS 52201 Alspa P8-25/35/05 Programming Software for Alspa C80-35, C80-25 and C80-05 PLCs User's Manual*.

Folders that contain locked subroutines may be cleared or deleted. If a folder contains locked subroutines, these blocks remain locked when the Alspa P8-25/35/05 software Copy, Backup, and Restore folder functions are used. For more information on program folders, please refer to chapter 7, *Program Folders*, in *ALS 52201*.

For detailed instructions on how to lock or unlock a subroutine, please refer to § 8., *Subroutine Blocks*, of chapter 3, *Program Editing*, in *ALS 52201*.

### Permanently Locking a Subroutine

In addition to VIEWLOCK and EDITLOCK, there are two types of permanent locks. If a PERMVIEWLOCK lock is set, all zooms into a subroutine are denied. If a PERMEDITLOCK lock is set, all attempts to edit the block are denied.

<b>WARNING</b>
----------------

**The permanent locks differ from the regular VIEWLOCK and EDITLOCK in that once set, they cannot be removed.**

Once a PERMEDITLOCK is set, it can only be changed to a PERMVIEWLOCK. A PERMVIEWLOCK cannot be changed to any other type of lock.

When you press the Enter key to initiate the locking, the software will prompt you to confirm any permanent lock.

## 6. ALSPA C80-35, C80-25 AND MICRO PLC I/O SYSTEM

The Alspa C80-35, C80-25 and Micro PLC systems provide the interface between the Alspa C80-35 PLC and user-supplied devices and equipment. Alspa C80-35 I/O is called Model 35 I/O. Model 35 I/O modules plug directly into slots in the CPU baseplate or into slots in any of the expansion baseplates for the Alspa C80-35 PLC Model 331 or higher. Model 331, 340 and 341 I/O systems support up to 49 Model 35 I/O modules. Model 351 I/O systems support up to 79 Model 35 I/O Modules. The Alspa C80-35 PLC Model 311 or Model 313 5-slot baseplate supports up to 5 Model 35 I/O modules; the 10-slot baseplate supports up to 10 Model 35 I/O modules.

The I/O structure for the Alspa C80-35 PLC is shown in the following figure.

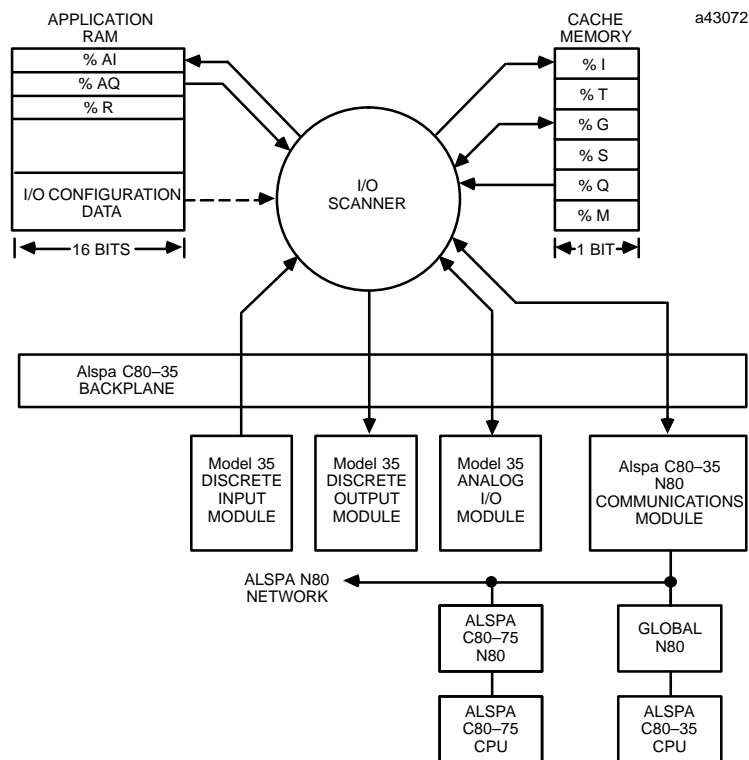

**Figure 2.7 – Alspa C80-35 I/O Structure**

**Note**

The drawing shown above is specific to the Alspa C80-35 I/O structure. For information about the Alspa C80-25 I/O structure, refer to the *ALS 52105 Alspa C80-25 PLC User's Manual*. For information about the Micro PLC I/O structure, refer to the *ALS 52119 Alspa C80-05 Micro PLC User's Manual*.

## 6.1. Model 35 I/O Modules

Model 35 I/O modules are available as five types: discrete input, discrete output, analog input, analog output and option modules. The following table lists the Model 35 I/O modules by catalog number, number of I/O points, and a brief description of each module.

<b>Note</b>
-------------

All of the I/O modules listed below may not be available at the time this manual is printed. For current availability, consult your local Cegelec PLC distributor or Cegelec sales representative. Refer to the *ALS 52118 Alspa C80–35 PLC I/O Module Specifications*, for the specifications and wiring information of each Model 35 I/O module.

**Table 2.9 – Model 35 I/O Modules**

Catalog Number	Points	Description	Manual Number
<b><i>Discrete Modules – Input</i></b>			
IC693MDL230	8	120 VAC Isolated	ALS 52118
IC693MDL231	8	240 VAC Isolated	ALS 52118
IC693MDL240	16	120 VAC	ALS 52118
IC693MDL241	16	24 VAC/DC Positive/Negative Logic	ALS 52118
IC693MDL632	8	125 VDC Positive/Negative Logic	ALS 52118
IC693MDL634	8	24 VDC Positive/Negative Logic	ALS 52118
IC693MDL645	16	24 VDC Positive/Negative Logic	ALS 52118
IC693MDL646	16	24 VDC Positive/Negative Logic, FAST	ALS 52118
CF693MDL100	16	48 VDC Positive/Negative Logic FAST	ALS 52118
IC693MDL654	32	5/12 VDC (TTL) Positive/Negative Logic	ALS 52118
IC693MDL655	32	24 VDC Positive/Negative Logic	ALS 52118
IC693ACC300	8/16	Input Simulator	ALS 52118
<b><i>Discrete Modules – Output</i></b>			
IC693MDL310	12	120 VAC, 0.5A	ALS 52118
IC693MDL330	8	120/240 VAC, 2A	ALS 52118
IC693MDL340	16	120 VAC, 0.5A	ALS 52118
IC693MDL390	5	120/240 VAC Isolated, 2A	ALS 52118
IC693MDL730	8	12/24 VDC Positive Logic, 2A	ALS 52118
IC693MDL731	8	12/24 VDC Negative Logic, 2A	ALS 52118
IC693MDL732	8	12/24 VDC Positive Logic, 0.5A	ALS 52118
IC693MDL733	8	12/24 VDC Negative Logic, 0.5A	ALS 52118
IC693MDL734	6	125 VDC Positive/Negative Logic, 2A	ALS 52118
IC693MDL740	16	12/24 VDC Positive Logic, 0.5A	ALS 52118
IC693MDL741	16	12/24 VDC Negative Logic, 0.5A	ALS 52118
IC693MDL742	16	12/24 VDC Positive Logic, 1A	ALS 52118
IC693MDL752	32	5/24 VDC (TTL) Negative Logic, 0.5A	ALS 52118
IC693MDL753	32	12/24 VDC Positive/Negative Logic, 0.5A	ALS 52118
IC693MDL930	8	Relay, N.O., 4A Isolated	ALS 52118
IC693MDL931	8	Relay, BC, Isolated	ALS 52118
IC693MDL940	16	Relay, N.O., 2A	ALS 52118

IC693MDR390	8/8	<b><u>Input/Output Modules</u></b> 24 VDC Input, Relay Output	ALS 52118
IC693MAR590	8/8		ALS 52118
IC693ALG220	4 ch	<b><u>Analog Modules</u></b> Analog Input, Voltage	ALS 52118
IC693ALG221	4 ch		ALS 52118
IC693ALG222	16		ALS 52118
IC693ALG223	16		ALS 52118
IC693ALG390	2 ch		ALS 52118
IC693ALG391	2 ch		ALS 52118
IC693ALG392	8 ch		ALS 52118
IC693ALG442	4/2		ALS 52118
IC693APU300	—	<b><u>Option Modules</u></b> High Speed Counter	ALS 52401
IC693CMM311	—		ALS 52506
IC693PCM301	—		ALS 52402
IC693PCM311	—		ALS 52402
IC693ADC311	—		ALS 52604
IC693BEM334	—		ALS 52511
IC693CMM304	—		ALS 52501
IC693CMM305	—		ALS 52502
IC693APU301	—		ALS 52607
IC693APU301	—		ALS 52403
IC693APU302	—		ALS 52607
IC693APU302	—		ALS 52403
IC693APU305	—		ALS 52309
IC693CMM321	—		ALS 52512

## 6.2. I/O Data Formats

Discrete inputs and discrete outputs are stored as bits in bit cache (status table) memory. Analog input and analog output data are stored as words and are memory resident in a portion of application RAM memory allocated for that purpose.

## 6.3. Default Conditions for Model 35 Output Modules

At power-up, Model 35 discrete output modules default to outputs off. They will retain this default condition until the first output scan from the PLC. Analog output modules can be configured with a jumper located on the module's removable terminal block to either default to zero or retain their last state. Also, analog output modules may be powered from an external power source so that, even though the PLC has no power, the analog output module will continue to operate in its selected default state.

## 6.4. Diagnostic Data

Diagnostic bits are available in %S memory that will indicate the loss of an I/O module or a mismatch in I/O configuration. Diagnostic information is not available for individual I/O points. More information on fault handling can be found later in this chapter and in chapter 3, *Fault Explanations and Correction*.

## 6.5. Global Data

The Alspa C80–35 PLC supports very fast sharing of data between multiple CPUs using N80 global data. The N80 bus controller, IC693BEM334 in CPU (version 5 and later) and the enhanced N80 Communications module, IC693CMM305, can broadcast up to 128 bytes of data to other PLCs or computers. They can receive up to 128 bytes from each of the up to 30 other NBC on the network. Data can be broadcast from or received into any memory type, not just %G global bits. The original N80 Communications module, IC693CMM304, was limited to fixed %G addresses and could only exchange 32 bits per serial bus address from SBA 16 to 23. This first card should not be used as the enhanced NCM has 50 times the capability.

Global data can be shared between Alspa 8000 PLCs existing on the same Alspa N80 network. There is a preconfigured method of sharing global data. No configuration is required by the user.

Global data is implemented by N80 Communications Modules transmitting data at I/O reference addresses based on their serial bus addresses. Each module can also read global data from up to seven other N80 Communications Modules.

## 6.6. Model 25 I/O Modules

The following I/O modules are available for the Alspa C80–25 PLC. Each module is listed by catalog number, number of I/O points, and a brief description. The I/O is integrated into a baseplate along with the power supply. For the specifications and wiring information of each module, refer to chapter 5 in the *ALS 52105 Alspa C80–25 PLC User's Manual*.

**Table 2.10 – Model 25 I/O Modules**

Catalog Number	Description	I/O Points
IC692MAA541	I/O and Power Supply Base Module, 120 VAC In/120 VAC Out/120 VAC Power Supply	16 In/12 Out
IC692MDR541	I/O and Power Supply Base Module 24 VDC In/Relay Out/120 VAC Power Supply	16 In/12 Out
IC692MDR741	I/O and Power Supply Base Module 24V DC In/Relay Out/240 VAC Power Supply	16 In/12 Out
IC692CPU212	CPU Module, Model CPU 212	Not Applicable

## 6.7. Micro PLCs

The following Alspa C80–05 Micro PLCs are available. Each Micro is listed by catalog number, number of I/O points and a brief description. The CPU, power supply and I/O are all part of one unit. For the specifications and wiring information of each module, refer to the *ALS 52119 Alspa C80–05 Micro PLC User's Manual*.

**Table 2.11 – Micro PLC Models**

<b>Catalog Number</b>	<b>Description</b>	<b>I/O Points</b>
CE693UDR001	CPU, Power Supply and I/O (all one unit) Micro–14 pt. DC In/Relay Out, AC Power Supply	8 In/6 Out
CE693UDR002	CPU, Power Supply and I/O (all one unit) Micro–14 pt. DC In/Relay Out, DC Power Supply	8 In/6 Out
CE693UAA003	CPU, Power Supply and I/O (all one unit) Micro–14 pt. AC In/AC Out, AC Power Supply	8 In/6 Out
CE693UAA007	CPU, Power Supply and I/O (all one unit) Micro–28 pt. AC In/AC Out, AC Power Supply	28 In/12 Out
CE693UDD005	CPU, Power Supply and I/O (all one unit) Micro–28 pt. DC In/Relay Out, AC Power Supply	28 In/12 Out, 1 DC out/ 11 relay Out)

# Chapter 3

## *Fault Explanations and Correction*

---

---

This chapter is an aid to troubleshooting the Alspa C80–35, Alspa C80–25 and Micro PLCs. It explains the fault descriptions, which appear in the PLC fault table, and the fault categories, which appear in the I/O fault table.

Each fault explanation in this chapter lists the fault description for the PLC fault table or the fault category for the I/O fault table. Find the fault description or fault category corresponding to the entry on the applicable fault table displayed on your programmer screen. Beneath it is a description of the cause of the fault along with instructions to correct the fault.

Chapter 3 contains the following paragraphs:

<b>Paragraph</b>	<b>Title</b>	<b>Description</b>	<b>Page</b>
1	Fault Handling	Describes the type of faults that may occur in the Alspa C80–35 or C80–25 PLC and how they are displayed in the fault tables. Descriptions of the PLC and I/O fault table displays are also included. For information on using CTRL-F to access additional fault information, refer to appendix B, “Interpreting Fault Tables Using AlspaP8–25/35/05 Micro Software.”	3–2
2	PLC Fault Table Explanations	Provides a fault description of each PLC fault and instructions to correct the fault.	3–9
3	I/O Fault Table Explanations	Describes the Loss of I/O Module and Addition of I/O Module fault categories.	3–18

Additional information on faults and fault handling may be found in the *ALS 52201 Alspa P8–25/35/05 Programming Software for Alspa C80–35, C80–25 and C80–05 PLCs User’s Manual*. For information on detecting and correcting errors in Statement List programs and the Hand–Held Programmer, refer to the *ALS 52202 Hand–Held Programmer for Alspa C80–35, C80–25 and C80–05 PLCs User’s Manual*.

## 1. FAULT HANDLING

<b>Note</b>
-------------

This information on fault handling applies to systems programmed using Alspa P8–25/35/05 software.

Faults occur in the Alspa C80–35, C80–25 or Micro PLCs when certain failures or conditions happen which affect the operation and performance of the system. These conditions, such as the loss of an I/O module or rack, may affect the ability of the PLC to control a machine or process. These conditions may also have beneficial effects, such as when a new module comes on–line and is now available for use. Or, these conditions may only act as an alert, such as a low battery signal which indicates that the battery protecting the memory needs to be changed.

### 1.1. Alarm Processor

The condition or failure itself is called a fault. When a fault is received and processed by the CPU, it is called an alarm. The software in the CPU which handles these conditions is called the Alarm Processor. The interface to the user for the Alarm Processor is through Alspa P8 programming software. Any detected fault is recorded in a fault table and displayed on either the PLC fault table screen or the I/O fault table screen, as applicable.

### 1.2. Classes of Faults

The Alspa C80–35, C80–25 and C80–05 PLCs detect several classes of faults. These include internal failures, external failures, and operational failures.

Fault Class	Examples
Internal Failures	Non–responding modules. Low battery condition. Memory checksum errors.
External I/O Failures	Loss of rack or module. Addition of rack or module.
Operational Failures	Communication failures. Configuration failures. Password access failures.

<b>Note</b>
-------------

For information specific to Alspa C80–05 Micro PLC fault handling, refer to chapter 7 of the *ALS 52119 Alspa C80–05 Micro PLC User’s Manual*.

### 1.3. System Reaction to Faults

Typically, hardware failures require that either the system be shut down or the failure is tolerated. I/O failures may be tolerated by the PLC system, but they may be intolerable by the application or the process being controlled. Operational failures are normally tolerated. Alspa C80–35, C80–25 and Micro PLC faults have two attributes:

Attribute	Description
Fault Table Affected	I/O fault table PLC fault table
Fault Action	Fatal Diagnostic Informational

#### 1.3.1. Fault Tables

Two fault tables are maintained in the PLC for logging faults, the I/O fault table for logging faults related to the I/O system and the PLC fault table for logging all other faults. The following table lists the fault groups, their fault actions, the fault tables affected, and the “nickname” for system discrete %S points that are affected.

**Table 3.1 – Fault Summary**

Fault Group	Fault Action	Fault Table	Special Discrete Fault References			
			ioflt	anyflt	iopres	losiom
Loss of or Missing I/O Module	Diagnostic	I/O	ioflt	anyflt	iopres	losiom
Loss of or Missing Option Module	Diagnostic	PLC	syflt	anyflt	sypres	losio
System Configuration Mismatch	Fatal	PLC	syflt	anyflt	sypres	cfgmm
PLC CPU Hardware Failure	Fatal	PLC	syflt	anyflt	sypres	hrdcpu
Program Checksum Failure	Fatal	PLC	syflt	anyflt	sypres	pbsum
Low Battery	Diagnostic	PLC	syflt	anyflt	sypres	lowbat
PLC Fault Table Full	Diagnostic	—	syfull			
I/O Fault Table Full	Diagnostic	—	iofull			
Application Fault	Diagnostic	PLC	syflt	anyflt	sypres	aplflt
No User Program	Informational	PLC	syflt	anyflt	sypres	noprog
Corrupted User RAM	Fatal	PLC	syflt	anyflt	sypres	badram
Password Access Failure	Diagnostic	PLC	syflt	anyflt	sypres	badpwd
PLC Software Failure	Fatal	PLC	syflt	anyflt	sypres	sftcpu
PLC Store Failure	Fatal	PLC	syflt	anyflt	sypres	storer
Constant Sweep Time Exceeded	Diagnostic	PLC	syflt	anyflt	sypres	ovswp
Unknown PLC Fault	Fatal	PLC	syflt	anyflt	sypres	
Unknown I/O Fault	Fatal	I/O	ioflt	anyflt	iopres	

### 1.3.2. Fault Action

Two fault tables are provided to make faults easier to find and to keep a single table from becoming too long. These tables are the PLC fault table and the I/O fault table.

Fatal faults cause the fault to be recorded in the appropriate table, any diagnostic variables to be set, and the system to be halted. Diagnostic faults are recorded in the appropriate table, and any diagnostic variables are set. Informational faults are only recorded in the appropriate table.

Possible fault actions are listed in the following table.

**Table 3.2 – Fault Actions**

Fault Action	Response by CPU
Fatal	Log fault in fault table. Set fault references. Go to STOP mode.
Diagnostic	Log fault in fault table. Set fault references.
Informational	Log fault in fault table.

When a fault is detected, the CPU uses the fault action for that fault. Fault actions are not configurable in the Alspa C80–35, C80–25 or Micro PLC.

### 1.4. Fault References

Fault references in the Alspa C80–35, C80–25 and Micro PLCs are of one type, fault summary references. Fault summary references are set to indicate what fault occurred. The fault reference remains on until the PLC is cleared or until cleared by the application program.

An example of a fault bit being set and then clearing the bit is shown in the following example. In this example, the coil light\_01 is turned on when an oversweep condition occurs; the light and the OV\_SWP contact remain on until the %I0359 contact is closed.

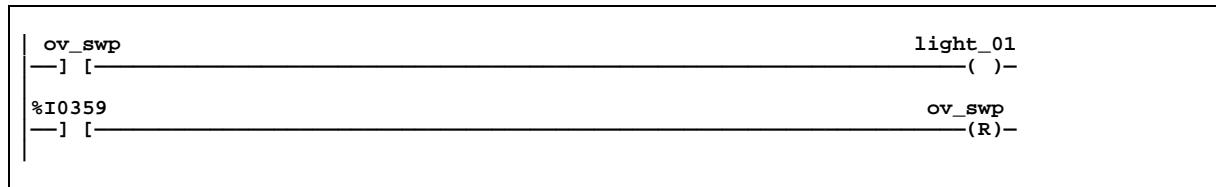

## 1.5. Fault Reference Definitions

The alarm processor maintains the states of the 128 system discrete bits in %S memory. These fault references can be used to indicate where a fault has occurred and what type of fault it is. Fault references are assigned to %S, %SA, %SB, and %SC memory, and they each have a nickname. These references are available for use in the application program as required. Refer to chapter 2, *System Operation*, for a list of the system status references.

## 1.6. Additional Fault Effects

Two faults described previously have additional effects associated with them. These are described in the following table.

Side Effect	Description
PLC CPU Software Failure	Whenever a PLC CPU software failure is logged, the Alspa C80–35 or C80–25 CPU immediately transitions into a special error sweep mode. No activity is permitted in this mode. The only method of clearing this condition is to reset the PLC (i.e., cycle power).
PLC Sequence Store Failure	During a sequence store (a store of program blocks and other data preceded with the special Start-of-Sequence command and ending with the End-of-Sequence command), if communications with the programming device performing the store is interrupted or any other failure occurs which terminates the download, the PLC Sequence Store Failure fault is logged. As long as this fault is present in the system, the PLC will not transition to <b>RUN</b> mode.

## 1.7. PLC Fault Table Display

The PLC Fault Table screen displays PLC faults such as password violations, PLC/configuration mismatches, parity errors, and communications errors. For example:

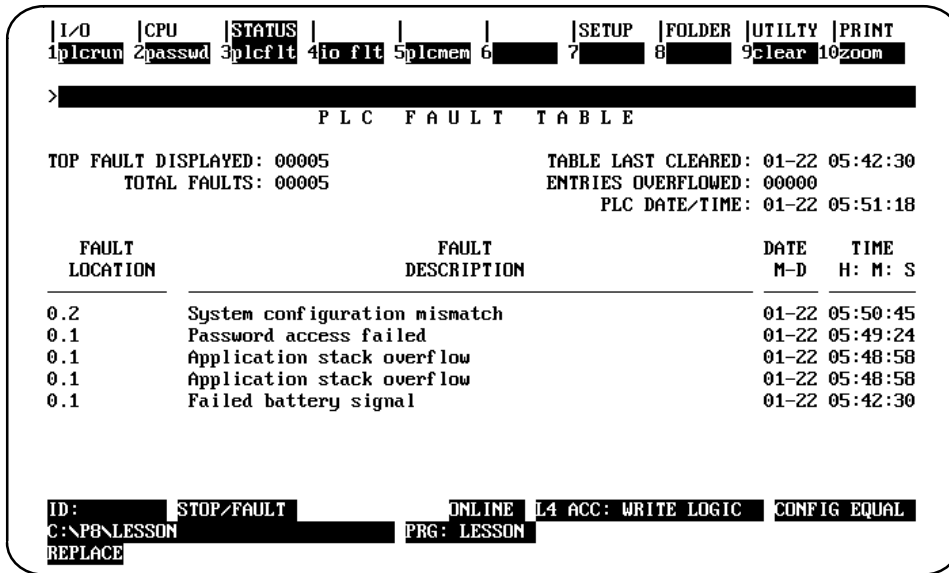

To display the PLC Fault Table screen, press **PLC Fault (F3)** from the PLC Control and Status menu or from another PLC Status functions screen. The programmer may be in any operating mode. If the programmer is in **OFFLINE** mode, no faults are displayed. In **ONLINE** or **MONITOR** mode, PLC fault data is displayed. In **ONLINE** mode, faults can be cleared (this may be password protected).

Once cleared, faults which are still present are not logged again in the table (except for the "Low-Battery" fault).

## 1.8. I/O Fault Table Display

The I/O Fault Table screen displays I/O faults such as circuit faults, address conflicts, forced circuits, and I/O bus faults. For example:

PROGRAM	TABLES	STATUS				SETUP	FOLDER	UTILITY	PRINT
1plcrun	2passwd	3plcflt	4ioflt	5plcmem	6blkmem	7refsiz	8sweep	9clear	10zoom
> I / O FAULT TABLE									
TOP FAULT DISPLAYED: 00002					TABLE LAST CLEARED: 01-21 08:26:37				
TOTAL FAULTS: 00002					ENTRIES OVERFLOWED: 00000				
FAULT DESCRIPTION:					PLC DATE/TIME: 01-22 05:54:48				
FAULT LOCATION	CIRC NO.	REFERENCE ADDR.	FAULT CATEGORY	FAULT TYPE	DATE M-D	TIME H: M: S			
0.3			ADD'N OF I/O MODULE		01-22	05:54:13			
0.3			ADD'N OF I/O MODULE		01-22	05:54:02			
ID: STOP/NO IO ONLINE L4 ACC: WRITE LOGIC CONFIG EQUAL C:\P8\LESSON PRG: LESSON REPLACE									

To display the I/O Fault Table screen, press **I/O Fault (F4)** from the PLC Control and Status menu or from another PLC Status functions screen. The programmer may be in any operating mode. If the programmer is in **OFFLINE** mode, no faults are displayed. In **ONLINE** or **MONITOR** mode, I/O fault data is displayed. In **ONLINE** mode, faults can be cleared (this feature may be password protected).

Once cleared, faults which are still present are not logged again in the table.

## 1.9. Accessing Additional Fault Information

The fault tables displayed by Alspa P8 software contain basic information regarding the fault. Additional information pertaining to each fault can be displayed by positioning the cursor on the fault entry and pressing the Zoom (F10) softkey from the PLC or I/O fault table screen. For more information about this fault zoom feature, refer to chapter 5, *PLC Control and Status*, in the *ALS 52201 Alspa P8-25/35/05 Programming Software for Alspa C80-35, C80-25 and C80-05 PLCs User's Manual*. In addition, a hexadecimal dump of the fault can be obtained by positioning the cursor on the fault entry and pressing the **CTRL-F** key sequence. For more information about using **CTRL-F**, refer to appendix B, *Interpreting Fault Tables Using Alspa P8-25/35/05 Software*, in this manual.

The last entry, Correction, for each fault explanation in this chapter lists the action(s) to be taken to correct the fault. Note that the corrective action for some of the faults includes the statement:

**Display the PLC Fault Table on the Programmer. Contact Cegelec Field Service, giving them all the information contained in the fault entry.**

This second statement means that you must tell Field Service both the information readable directly from the fault table *and* the hexadecimal information you see when you press **CTRL-F**. Field Service personnel will then give you further instructions for the appropriate action to be taken.

An example of the I/O Fault Zoom screen displaying this information is shown below.

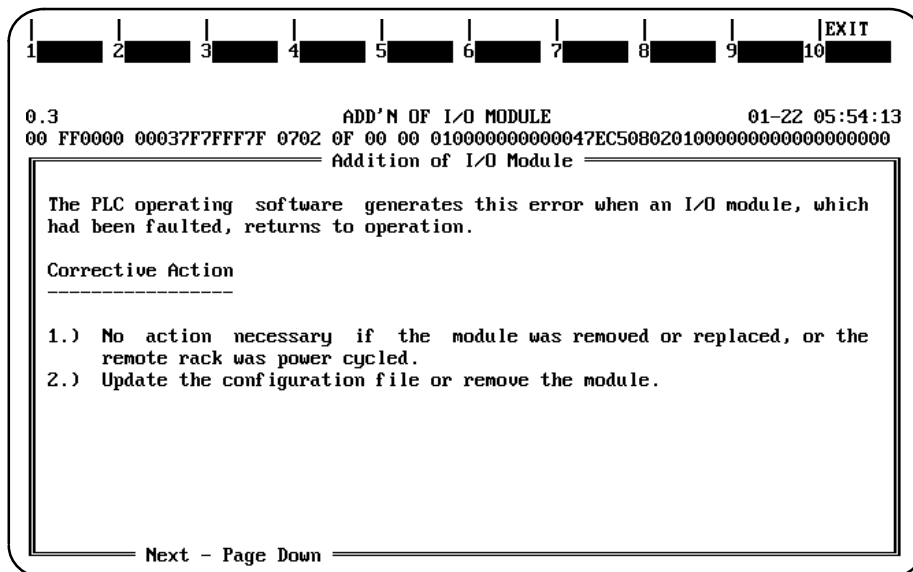

## 2. PLC FAULT TABLE EXPLANATIONS

Each fault explanation contains a fault description and instructions to correct the fault. Many fault descriptions have multiple causes. In these cases, the error code, displayed with the additional fault information obtained by pressing **CTRL-F**, is used to distinguish different fault conditions sharing the same fault description. (For more information about using CTRL-F, refer to appendix B, *Interpreting Fault Tables Using Alspa P8-25/35/05 Software*, in this manual.) The error code is the first two hexadecimal digits in the fifth group of numbers, as shown in the following example.

<pre>01  000000  01030100  0902  0200  000000000000                                    _____ Error Code (first two hex                         digits in fifth group)</pre>
---

Some faults can occur because random access memory on the PLC CPU board has failed. These same faults may also occur because the system has been powered off and the battery voltage is (or was) too low to maintain memory. To avoid excessive duplication of instructions when corrupted memory may be a cause of the error, the correction simply states:

**Perform the corrections for Corrupted Memory.**

This means:

1. If the system has been powered off, replace the battery. Battery voltage may be insufficient to maintain memory contents.
2. Replace the PLC CPU board. The integrated circuits on the PLC CPU board may be failing.

The following table enables you to quickly find a particular PLC fault explanation in this section. Each entry is listed as it appears on the programmer screen.

Fault Description	Page
Loss of, or Missing, Option Module	3-10
Reset of, Addition of, or Extra, Option Module	3-10
System Configuration Mismatch	3-11
Option Module Software Failure	3-11
Program Block Checksum Failure	3-12
Low Battery Signal	3-12
Constant Sweep Time Exceeded	3-12
Application Fault	3-13
No User Program Present	3-13
Corrupted User Program on Power-Up	3-14
Password Access Failure	3-14
PLC CPU System Software Failure	3-15
Communications Failure During Store	3-17

## 2.1. Fault Actions

**Fatal** faults cause the PLC to enter a form of **STOP** mode at the end of the sweep in which the error occurred. **Diagnostic** faults are logged and corresponding fault contacts are set. **Informational** faults are simply logged in the PLC fault table.

## 2.2. Loss of, or Missing, Option Module

The Fault Group **Loss of, or Missing Option Module** occurs when a PCM, CMM or ADC fails to respond. The failure may occur at power-up if the module is missing or during operation if the module fails to respond. The fault action for this group is **Diagnostic**.

<b>Error Code:</b>	1, 42
<b>Name:</b>	Option Module Soft Reset Failed
<b>Description:</b>	PLC CPU unable to re-establish communications with option module after soft reset.
<b>Correction:</b>	<ol style="list-style-type: none"> <li>(1) Try soft reset a second time.</li> <li>(2) Replace the option module.</li> <li>(3) Power off the system. Verify that the PCM is seated properly in the rack and that all cables are properly connected and seated.</li> <li>(4) Replace the cables.</li> </ol>
<b>Error Code:</b>	All Others
<b>Name:</b>	Module Failure During Configuration
<b>Description:</b>	The PLC operating software generates this error when a module fails during power-up or configuration store.
<b>Correction:</b>	<ol style="list-style-type: none"> <li>(1) Power off the system. Replace the module located in that rack and slot.</li> </ol>

## 2.3. Reset of, Addition of, or Extra, Option Module

The Fault Group **Reset of, Addition of, or Extra Option Module** occurs when an option module (PCM, ADC, etc.) comes on-line, is reset, or a module is found in the rack, but none is specified in the configuration. The fault action for this group is **Diagnostic**. Three bytes of fault specific data provide additional information regarding the fault.

<b>Correction:</b>	<ol style="list-style-type: none"> <li>(1) Update the configuration file to include the module.</li> <li>(2) Remove the module from the system.</li> </ol>
--------------------	--

## 2.4. System Configuration Mismatch

The Fault Group **Configuration Mismatch** occurs when the module occupying a slot is different from that specified in the configuration file. The fault action is **Fatal**.

<b>Error Code:</b>	1
<b>Name:</b>	System Configuration Mismatch
<b>Description:</b>	The PLC operating software (system configurer) generates this fault when the module occupying a slot is not of the same type that the configuration file indicates should be in that slot or when the configured rack type does not match the actual rack present.
<b>Correction:</b>	Identify the mismatch and reconfigure the module or rack.
<b>Error Code:</b>	6
<b>Name:</b>	System Configuration Mismatch
<b>Description:</b>	This is the same as error code 1 in that this fault occurs when the module occupying a slot is not of the same type that the configuration file indicates should be in that slot or when the configured rack type does not match the actual rack present.
<b>Correction:</b>	Identify the mismatch and reconfigure the module or rack.
<b>Error Code:</b>	18
<b>Name:</b>	Unsupported Hardware
<b>Description:</b>	A PCM or PCM-type module is present in a 311, 313 or 323 or in an extension rack.
<b>Correction:</b>	Physically correct the situation by removing the PCM or PCM-type module or install a CPU that does support the PCM.
<b>Error Code:</b>	26
<b>Name:</b>	Module busy—config not yet accept by module
<b>Description:</b>	The module cannot accept new configuration at this time because it is busy with a different process.
<b>Correction:</b>	Allow the module to complete the current operation and re-store the configuration.
<b>Error Code:</b>	51
<b>Name:</b>	END Function Executed from SFC Action
<b>Description:</b>	The placement of an END function in SFC logic or in logic called by SFC will produce this fault—refer to the Note on page 4–97 for more information about the END function and SFC logic.
<b>Correction:</b>	Remove the END function from the SFC logic or logic being called by the SFC logic.

## 2.5. Option Module Software Failure

The Fault Group **Option Module Software Failure** occurs when a non-recoverable software failure occurs on a PCM or ADC module. The fault action for this group is **Fatal**.

<b>Error Code:</b>	All
<b>Name:</b>	COMMREQ Frequency Too High
<b>Description:</b>	COMMREQs are being sent to a module faster than it can process them.
<b>Correction:</b>	Change the PLC program to send COMMREQs to the affected module at a slower rate.

## 2.6. Program Block Checksum Failure

The Fault Group **Program Block Checksum Failure** occurs when the PLC CPU detects error conditions in program blocks received by the PLC. It also occurs when the PLC CPU detects checksum errors during power-up verification of memory or during RUN mode background checking. The fault action for this group is **Fatal**.

<b>Error Code:</b>	All
<b>Name:</b>	Program Block Checksum Failure
<b>Description:</b>	The PLC Operating Software generates this error when a program block is corrupted.
<b>Correction:</b>	<ol style="list-style-type: none"> <li>(1) Clear PLC memory and retry the store.</li> <li>(2) Display the PLC fault table on the programmer. Contact Cegelec PLC Field Service, giving them all the information contained in the fault entry.</li> </ol>

## 2.7. Low Battery Signal

The Fault Group **Low Battery Signal** occurs when the PLC CPU detects a low battery on the PLC power supply or a module, such as the PCM, reports a low battery condition. The fault action for this group is **Diagnostic**.

<b>Error Code:</b>	0
<b>Name:</b>	Failed Battery Signal
<b>Description:</b>	The CPU module (or other module having a battery) battery is dead.
<b>Correction:</b>	Replace the battery. Do not remove power from the rack.
<b>Error Code:</b>	1
<b>Name:</b>	Low Battery Signal
<b>Description:</b>	A battery on the CPU, or other module has a low signal.
<b>Correction:</b>	Replace the battery. Do not remove power from the rack.

## 2.8. Constant Sweep Time Exceeded

The Fault Group **Constant Sweep Time Exceeded** occurs when the PLC CPU operates in **CONSTANT SWEEP** mode, and it detects that the sweep has exceeded the constant sweep timer. The fault extra data contains the actual time of the sweep in the first two bytes and the name of the program in the next eight bytes. The fault action for this group is **Diagnostic**.

<b>Correction:</b>	<ol style="list-style-type: none"> <li>(1) Increase constant sweep time.</li> <li>(2) Remove logic from application program.</li> </ol>
--------------------	---

## 2.9. Application Fault

The Fault Group **Application Fault** occurs when the PLC CPU detects a fault in the user program. The fault action for this group is **Diagnostic**.

<b>Error Code:</b>	7
<b>Name:</b>	Subroutine Call Stack Exceeded
<b>Description:</b>	Subroutine calls are limited to a depth of 8. A subroutine can call another subroutine which, in turn, can call another subroutine until 8 call levels are attained.
<b>Correction:</b>	Modify program so that subroutine call depth does not exceed 8.
<b>Error Code:</b>	1B
<b>Name:</b>	Comm Req Not Processed Due To PLC Memory Limitations
<b>Description:</b>	No-wait communication requests can be placed in the queue faster than they can be processed (e.g., one per sweep). In a situation like this, when the communication requests build up to the point that the PLC has less than a minimum amount of memory available, the communication request will be faulted and not processed
<b>Correction:</b>	Issue fewer communication requests or otherwise reduce the amount of mail being exchanged within the system.
<b>Error Code:</b>	5A
<b>Name:</b>	User Shut Down Requested
<b>Description:</b>	The PLC operating software (function blocks) generates this informational alarm when Service Request No. 13 (User Shut Down) executes in the application program.
<b>Correction:</b>	None required. Information-only alarm.

## 2.10. No User Program Present

The Fault Group **No User Program Present** occurs when the PLC CPU is instructed to transition from **STOP** to **RUN** mode or a store to the PLC and no user program exists in the PLC. The PLC CPU detects the absence of a user program on power-up. The fault action for this group is **Informational**.

<b>Correction:</b>	Download an application program before attempting to go to RUN mode.
--------------------	--

## 2.11. Corrupted User Program on Power-Up

The Fault Group **Corrupted User Program on Power-Up** occurs when the PLC CPU detects corrupted user RAM. The PLC CPU will remain in **STOP** mode until a valid user program and configuration file are downloaded. The fault action for this group is **Fatal**.

<b>Error Code:</b>	1
<b>Name:</b>	Corrupted User RAM on Power-Up
<b>Description:</b>	The PLC operating software (operating software) generates this error when it detects corrupted user RAM on power-up.
<b>Correction:</b>	<ol style="list-style-type: none"> <li>(1) Reload the configuration file, user program, and references (if any).</li> <li>(2) Replace the battery on the PLC CPU.</li> <li>(3) Replace the expansion memory board on the PLC CPU.</li> <li>(4) Replace the PLC CPU.</li> </ol>
<b>Error Code:</b>	2
<b>Name:</b>	Illegal Boolean OpCode Detected
<b>Description:</b>	The PLC operating software (operating software) generates this error when it detects a bad instruction in the user program.
<b>Correction:</b>	<ol style="list-style-type: none"> <li>(1) Restore the user program and references (if any).</li> <li>(2) Replace the expansion memory board on the PLC CPU.</li> <li>(3) Replace the PLC CPU.</li> </ol>

## 2.12. Password Access Failure

The Fault Group **Password Access Failure** occurs when the PLC CPU receives a request to change to a new privilege level and the password included with the request is not valid for that level. The fault action for this group is **Informational**.

<b>Correction:</b>	Retry the request with the correct password.
--------------------	--

## 2.13. PLC CPU System Software Failure

Faults in the Fault Group **PLC CPU System Software Failure** are generated by the operating software of the Alspa C80–35, C80–25 or C80–05 PLC CPU. They occur at many different points of system operation. When a **Fatal** fault occurs, the PLC CPU *immediately* transitions into a special **ERROR SWEEP** mode. The only activity permitted when the PLC is in this mode is communications with the programmer. The only way to clear this condition is to cycle power on the PLC. The fault action for this group is **Fatal**.

<b>Error Code:</b>	1 through B
<b>Name:</b>	User Memory Could Not Be Allocated
<b>Description:</b>	The PLC operating software (memory manager) generates these errors when software requests the memory manager to allocate or de-allocate a block or blocks of memory from user RAM that are not legal. These errors should <i>not</i> occur in a production system.
<b>Correction:</b>	Display the PLC fault table on the programmer. Contact Cegelec PLC Field Service, giving them all the information contained in the fault entry.
<b>Error Code:</b>	D
<b>Name:</b>	System Memory Unavailable
<b>Description:</b>	The PLC operating software (I/O Scanner) generates this error when its request for a block of system memory is denied by the memory manager because no memory is available from the system memory heap. It is <i>Informational</i> if the error occurs during the execution of a DO I/O function block. It is <i>Fatal</i> if it occurs during power-up initialization or auto configuration.
<b>Correction:</b>	Display the PLC fault table on the programmer. Contact Cegelec PLC Field Service, giving them all the information contained in the fault entry.
<b>Error Code:</b>	E
<b>Name:</b>	System Memory Could Not Be Freed
<b>Description:</b>	The PLC operating software (I/O Scanner) generates this error when it requests the memory manager to deallocate a block of system memory and the deallocation fails. This error can only occur during the execution of a DO I/O function block.
<b>Correction:</b>	(1) Display the PLC fault table on the programmer. Contact Cegelec PLC Field Service, giving them all the information contained in the fault entry. (2) Perform the corrections for corrupted memory.
<b>Error Code:</b>	10
<b>Name:</b>	Invalid Scan Request of the I/O Scanner
<b>Description:</b>	The PLC operating software (I/O Scanner) generates this error when the operating system or DO I/O function block scan requests neither a full nor a partial scan of the I/O. This should <i>not</i> occur in a production system.
<b>Correction:</b>	Display the PLC fault table on the programmer. Contact Cegelec PLC Field Service, giving them all the information contained in the fault entry.
<b>Error Code:</b>	13
<b>Name:</b>	PLC Operating Software Error
<b>Description:</b>	The PLC operating software generates this error when certain PLC operating software problems occur. This error should <i>not</i> occur in a production system.
<b>Correction:</b>	(1) Display the PLC fault table on the programmer. Contact Cegelec PLC Field Service, giving them all the information contained in the fault entry. (2) Perform the corrections for corrupted memory.

<b>Error Code:</b>	14, 27
<b>Name:</b>	Corrupted PLC Program Memory
<b>Description:</b>	The PLC operating software generates these errors when certain PLC operating software problems occur. These should <i>not</i> occur in a production system.
<b>Correction:</b>	(1) Display the PLC fault table on the programmer. Contact Cegelec PLC Field Service, giving them all the information contained in the fault entry. (2) Perform the corrections for corrupted memory.
<b>Error Code:</b>	27 to 4E
<b>Name:</b>	PLC Operating Software Error
<b>Description:</b>	The PLC operating software generates these errors when certain PLC operating software problems occur. These errors should <i>not</i> occur in a production system.
<b>Correction:</b>	Display the PLC fault table on the programmer. Contact Cegelec PLC Field Service, giving them all the information contained in the fault entry.
<b>Error Code:</b>	4F
<b>Name:</b>	Communications Failed
<b>Description:</b>	The PLC operating software (service request processor) generates this error when it attempts to comply with a request that requires backplane communications and receives a rejected response.
<b>Correction:</b>	(1) Check the bus for abnormal activity. (2) Replace the intelligent option module to which the request was directed.
<b>Error Code:</b>	50, 51, 53
<b>Name:</b>	System Memory Errors
<b>Description:</b>	The PLC operating software generates these errors when its request for a block of system memory is denied by the memory manager because no memory is available or contains errors.
<b>Correction:</b>	(1) Display the PLC fault table on the programmer. Contact Cegelec PLC Field Service, giving them all the information contained in the fault entry. (2) Perform the corrections for corrupted memory.
<b>Error Code:</b>	52
<b>Name:</b>	Backplane Communications Failed
<b>Description:</b>	The PLC operating software (service request processor) generates this error when it attempts to comply with a request that requires backplane communications and receives a rejected mail response.
<b>Correction:</b>	(1) Check the bus for abnormal activity. (2) Replace the intelligent option module to which the request was directed. (3) Check parallel programmer cable for proper attachment.
<b>Error Code:</b>	All Others
<b>Name:</b>	PLC CPU Internal System Error
<b>Description:</b>	An internal system error has occurred that should <b>not</b> occur in a production system.
<b>Correction:</b>	Display the PLC fault table on the programmer. Contact Cegelec PLC Field Service, giving them all the information contained in the fault entry.

## 2.14. Communications Failure During Store

The Fault Group **Communications Failure During Store** occurs during the store of program blocks and other data to the PLC. The stream of commands and data for storing program blocks and data starts with a special start-of-sequence command and terminates with an end-of-sequence command. If communications with the programming device performing the store is interrupted or any other failure occurs which terminates the load, this fault is logged. As long as this fault is present in the system, the controller will not transition to **RUN** mode.

This fault is *not* automatically cleared on power-up; the user must specifically order the condition to be cleared. The fault action for this group is **Fatal**.

<b>Correction:</b>	Clear the fault and retry the download of the program or configuration file.
--------------------	--

### 3. I/O FAULT TABLE EXPLANATIONS

The I/O fault table reports data about faults in three classifications:

- Fault category.
- Fault type.
- Fault description.

The faults described on the following page have a fault category, but do not have a fault type or fault group.

Each fault explanation contains a fault description and instructions to correct the fault. Many fault descriptions have multiple causes. In these cases, the error code, displayed with the additional fault information obtained by pressing CTRL-F, is used to distinguish different fault conditions sharing the same fault description. (For more information about using CTRL-F, refer to appendix B, *Interpreting Fault Tables Using Alspa P8-25/35/05 Software*, in this manual.) The error code is the first two hexadecimal digits in the fifth group of numbers, as shown in the following example.

```
01  000000  01030100  0902  0200  000000000000
                |_____ Error Code (first two hex
                |_____ digits in fifth group)
```

The following table enables you to quickly find a particular I/O fault explanation in this section. Each entry is listed as it appears on the programmer screen.

### 3.1. Loss of I/O Module

The Fault Category **Loss of I/O Module** applies to Model 35 discrete and analog I/O modules. There are no fault types or fault descriptions associated with this category. The fault action is **Diagnostic**.

<b>Description:</b>	The PLC operating software generates this error when it detects that a Model 35 I/O module is no longer responding to commands from the PLC CPU, or when the configuration file indicates an I/O module is to occupy a slot and no module exists in the slot.
<b>Correction:</b>	<ol style="list-style-type: none"> <li>(1) Replace the module.</li> <li>(2) Correct the configuration file.</li> <li>(3) Display the PLC fault table on the programmer. Contact Cegelec PLC Field Service, giving them all the information contained in the fault entry.</li> </ol>

### 3.2. Addition of I/O Module

The Fault Category **Addition of I/O Module** applies to Model 35 discrete and analog I/O modules. There are no fault types or fault descriptions associated with this category. The fault action is **Diagnostic**.

<b>Description:</b>	The PLC operating software generates this error when an I/O module which had been faulted returns to operation.
<b>Correction:</b>	<ol style="list-style-type: none"> <li>(1) No action necessary if the module was removed or replaced, or the remote rack was power cycled.</li> <li>(2) Update the configuration file or remove the module.</li> </ol>
<b>Description:</b>	The PLC operating software generates this error when it detects a Model 35 I/O module in a slot which the configuration file indicates should be empty.
<b>Correction:</b>	<ol style="list-style-type: none"> <li>(1) Remove the module. (It may be in the wrong slot.)</li> <li>(2) Update and restore the configuration file to include the extra module.</li> </ol>



# Chapter 4

## Alspa P8–25/35/05 Instruction Set

Programming consists of creating an application program for a PLC. Because the Alspa C80–35, C80–25 and C80–05 PLCs have a common instruction set, all three can be programmed using this software. This chapter describes the programming instructions that may be used to create ladder logic programs for the Alspa C80–35 and Alspa C80–25 programmable controllers.

If Alspa P8–25/35/05 programming software is not yet installed, please refer to the *ALS 52201 Alspa P8–25/35/05 Programming Software for Alspa C80–35, C80–25 and C80–05 PLCs User's Manual*, for instructions. The user's manual explains how to create, transfer, edit, and print programs.

Configuration is the process of assigning logical addresses, as well as other characteristics, to the hardware modules in the system. It may be done either before or after programming, using the configuration software or Hand–Held Programmer; however, it is recommended that configuration be done first. If that has not been done, you should refer to the *ALS 52201 Alspa P8–25/35/05 Programming Software for Alspa C80–35, C80–25 and C80–05 PLCs User's Manual*, to decide whether it is best to begin programming at this time.

This chapter contains the following paragraphs:

Paragraph	Title	Description	Page
1	Relay Functions	Describes contacts, coils, and links.	4–2
2	Timers and Counters	Describes on–delay and stopwatch–type timers, up counters, and down counters.	4–9
3	Math Functions	Describes addition, subtraction, multiplication, division, modulo division and square root, trigonometric functions, logarithmic/exponential functions, and radian conversion.  <i>Note that trigonometric functions, logarithmic/exponential functions, and radian conversion functions are only available with the model 352 CPU.</i>	4–23
4	Relational Functions	Describes how to compare two numbers for equality, non–equality, greater than, greater than or equal to, less than, and less than or equal to.	4–35
5	Bit Operation Functions	Describes how to perform comparison and move operations on bitstrings.	4–40
6	Data Move Functions	Describes basic data move capabilities.	4–60
7	Table Functions	Describes how to use table functions to enter values into and copy values out of a table.	4–75
8	Conversion Functions	Describes how to convert a data item from one number type to another.	4–82
9	Control Functions	Describes how to limit program execution and alter the way the CPU executes the application program by using the control functions.	4–90

## 1. RELAY FUNCTIONS

This paragraph explains the use of contacts, coils, and links in ladder logic rungs.

Function	Page
Coils and negated coils.	4-4
Normally open and normal closed contacts.	4-3
Retentive and negated retentive coils.	4-4
Positive and negative transition coils.	4-5
SET and RESET coils.	4-5
Retentive SET and RESET coils.	4-6
Horizontal and vertical links.	4-7
Continuation coils and contacts.	4-8

### 1.1. Using Contacts

A contact is used to monitor the state of a reference. Whether the contact passes power flow depends on the state or status of the reference being monitored and on the contact type. A reference is ON if its state is 1; it is OFF if its state is 0.

**Table 4.1 – Types of Contacts**

Type of Contact	Display	Contact Passes Power to Right:
Normally Open	— —	When reference is ON.
Normally Closed	— /—	When reference is OFF.
Continuation Contact	<+>——	If the preceding continuation coil is set ON.

### 1.2. Using Coils

Coils are used to control discrete references. Conditional logic must be used to control the flow of power to a coil. Coils cause action directly they do not pass power flow to the right. If additional logic in the program should be executed as a result of the coil condition, an internal reference should be used for that coil or a continuation coil/contact combination may be used.

Coils are always located at the rightmost position of a line of logic. A rung may contain up to eight coils.

The type of coil used will depend on the type of program action desired. The states of retentive coils are saved when power is cycled or when the PLC goes from **STOP** to **RUN** mode. The states of non-retentive coils are set to zero when power is cycled or the PLC goes from **STOP** to **RUN** mode.

**Table 4.2 – Types of Coils**

Type of Coil	Display	Power to Coil	Result
Normally Open	—( )—	ON OFF	Set reference ON. Set reference OFF.
Negated	—(/)—	ON OFF	Set reference OFF. Set reference ON.
Retentive	—(M)—	ON OFF	Set reference ON, retentive. Set reference OFF, retentive.
Negated Retentive	—(/M)—	ON OFF	Set reference OFF, retentive. Set reference ON, retentive.
Positive Transition	—↑—	OFF→ON	If reference is OFF, set it ON for one sweep.
Negative Transition	—↓—	ON←OFF	If reference is OFF, set it ON for one sweep.
SET	—(S)—	ON OFF	Set reference ON until reset OFF by —(R)—. Do not change the coil state.
RESET	—(R)—	ON OFF	Set reference OFF until set ON by —(S)—. Do not change the coil state.
Retentive SET	—(SM)—	ON OFF	Set reference ON until reset OFF by —(RM)—, retentive. Do not change the coil state.
Retentive RESET	—(RM)—	ON OFF	Set reference OFF until set ON by —(SM)—, retentive. Do not change the coil state.
Continuation Coil	———<+>	ON OFF	Set next continuation contact ON. Set next continuation contact OFF.

### 1.3. Normally Open Contact —| |—

A normally open contact acts as a switch that passes power flow if the associated reference is ON (1).

### 1.4. Normally Closed Contact —|/|—

A normally closed contact acts as a switch that passes power flow if the associated reference is OFF (0).

**Example:**

The following example shows a rung with 10 elements having nicknames from E1 to E10. Coil E10 is ON when references E1, E2, E5, E6 and E9 are ON and references E3, E4, E7 and E8 are OFF.

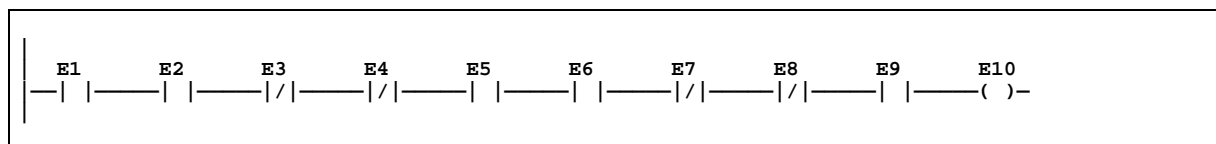

## 1.5. Coil —( )—

A coil sets a discrete reference ON while it receives power flow. It is non-retentive therefore, it cannot be used with system status references (%SA, %SB, %SC, or %G).

### Example:

In the following example, coil E3 is ON when reference E1 is ON and reference E2 is OFF.

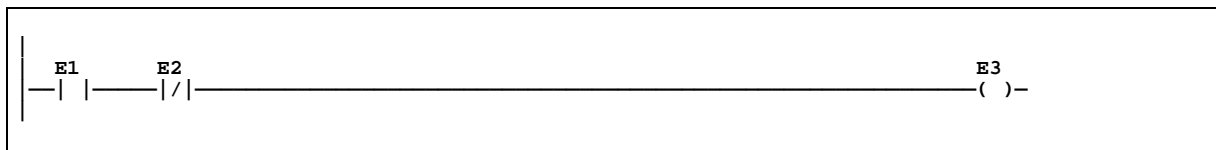

## 1.6. Negated Coil —(/)—

A negated coil sets a discrete reference ON when it does not receive power flow. It is not retentive therefore, it cannot be used with system status references (%SA, %SB, %SC, or %G).

### Example:

In the following example, coil E3 is ON when reference E1 is OFF.

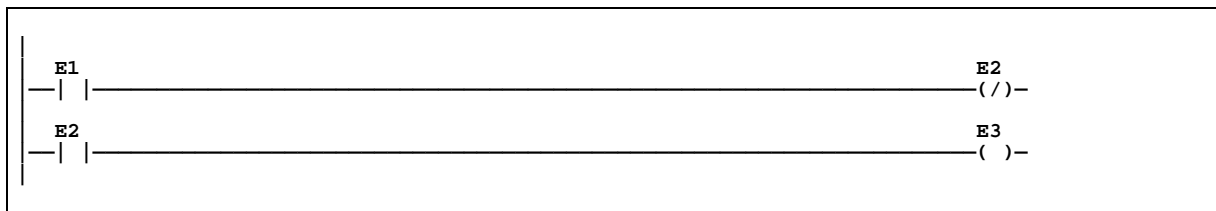

## 1.7. Retentive Coil —(M)—

Like a normally open coil, the retentive coil sets a discrete reference ON while it receives power flow. The state of the retentive coil is retained across power failure. Therefore, it cannot be used with references from strictly non-retentive memory (%T).

## 1.8. Negated Retentive Coil —(/M)—

The negated retentive coil sets a discrete reference ON when it does not receive power flow. The state of the negated retentive coil is retained across power failure. Therefore, it cannot be used with references from strictly non-retentive memory (%T).

### 1.9. Positive Transition Coil —(↑)—

If the reference associated with a positive transition coil is OFF, when the coil receives power flow it is set to ON until the next time the coil is executed. (If the rung containing the coil is skipped on subsequent sweeps, it will remain ON.) This coil can be used as a one-shot.

Do not write from external devices (e.g., PCM, programmer, ADS, etc.) to references used on positive transition coils since it will destroy the one-shot nature of these coils.

Transitional coils can be used with references from either retentive or non-retentive memory (%Q, %M, %T, %G, %SA, %SB, or %SC).

### 1.10. Negative Transition Coil —(↓)—

If the reference associated with this coil is OFF, when the coil stops receiving power flow, the reference is set to ON until the next time the coil is executed.

Do not write from external devices to references used on negative transition coils since it will destroy the one-shot nature of these coils.

Transitional coils can be used with references from either retentive or non-retentive memory (%Q, %M, %T, %G, %SA, %SB, or %SC).

**Example:**

In the following example, when reference E1 goes from OFF to ON, coils E2 and E3 receive power flow, turning E2 ON for one logic sweep. When E1 goes from ON to OFF, power flow is removed from E2 and E3, turning coil E3 ON for one sweep.

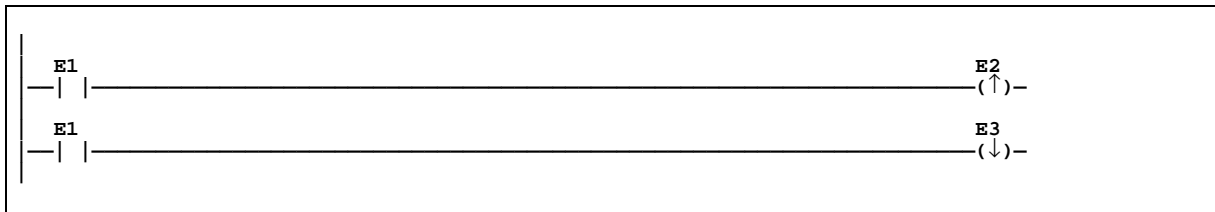

### 1.11. SET Coil —(S)—

SET and RESET are non-retentive coils that can be used to keep (“latch”) the state of a reference (e.g., E1) either ON or OFF. When a SET coil receives power flow, its reference stays ON (whether or not the coil itself receives power flow) until the reference is reset by another coil.

SET coils write an undefined result to the transition bit for the given reference. (Refer to the information on “Transitions and Overrides” in chapter 2, *System Operation*.)

## 1.12. RESET Coil —(R)—

The RESET coil sets a discrete reference OFF if the coil receives power flow. The reference remains OFF until the reference is reset by another coil. The last-solved SET coil or RESET coil of a pair takes precedence.

RESET coils write an undefined result to the transition bit for the given reference. (Refer to the information on “Transitions and Overrides” in chapter 2, *System Operation*.)

### Example:

In the following example, the coil represented by E1 is turned ON whenever reference E2 or E6 is ON. The coil represented by E1 is turned OFF whenever reference E5 or E3 is ON.

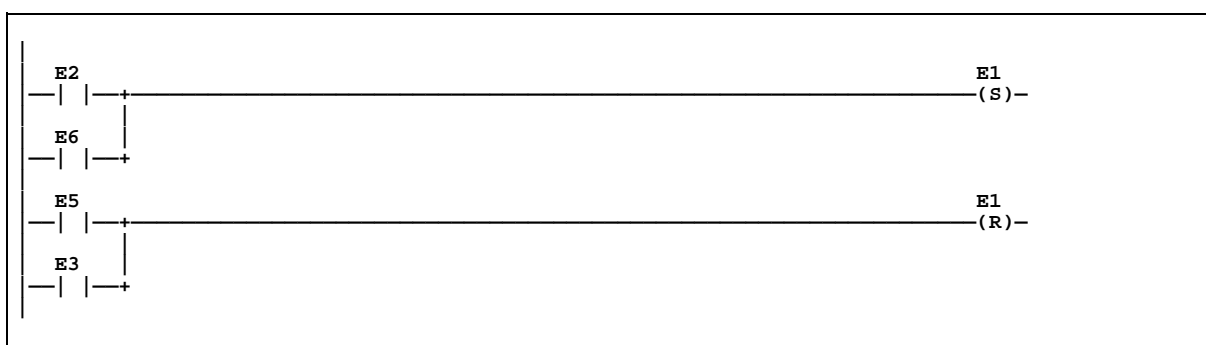

### Note

When the level of coil checking is SINGLE, you can use a specific %M or %Q reference with only one Coil, but you can use it with one SET Coil and one RESET Coil simultaneously. When the level of coil checking is WARN MULTIPLE or MULTIPLE, then each reference can be used with multiple Coils, SET Coils and RESET Coils. With multiple usage, a reference could be turned ON by either a SET Coil or a normal Coil and could be turned OFF by a RESET Coil or by a normal Coil.

## 1.13. Retentive SET Coil —(SM)—

Retentive SET and RESET coils are similar to SET and RESET coils, but they are retained across power failure or when the PLC transitions from **STOP** to **RUN** mode. A retentive SET coil sets a discrete reference ON if the coil receives power flow. The reference remains ON until reset by a retentive RESET coil.

Retentive SET coils write an undefined result to the transition bit for the given reference. (Refer to the information on “Transitions and Overrides” in chapter 2, *System Operation*.)

### 1.14. Retentive RESET Coil —(RM)—

This coil sets a discrete reference OFF if it receives power flow. The reference remains OFF until set by a retentive SET coil. The state of this coil is retained across power failure or when the PLC transitions from **STOP** to **RUN** mode.

Retentive RESET coils write an undefined result to the transition bit for the given reference. (Refer to the information on “Transitions and Overrides” in chapter 2, *System Operation*.)

### 1.15. Links

Horizontal and vertical links are used to connect elements of a line of ladder logic between functions. Their purpose is to complete the flow of logic (“power”) from left to right in a line of logic.

**Note**

You can not use a horizontal link to tie a function or coil to the left power rail. You can, however, use %S7, the AWL\_ON (always on) system bit with a normally open contact tied to the power rail to call a function every sweep.

**Example:**

In the following example, two horizontal links are used to connect contacts E2 and E5. A vertical link is used to connect contacts E3, E6, E7, E8, and E9 to E2.

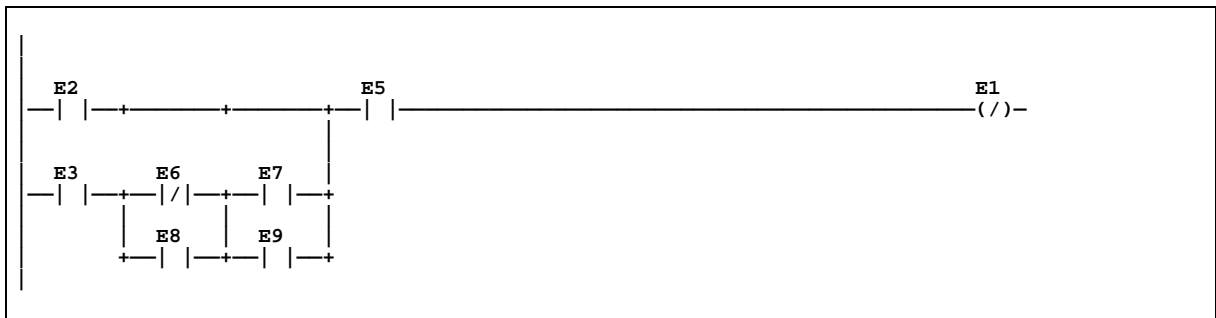

## 1.16. Continuation Coils (—<+>) and Contacts (<+>—)

Continuation coils (—<+>) and continuation contacts (<+>—) are used to continue relay ladder rung logic beyond the limit of ten columns. The state of the last executed continuation coil is the flow state that will be used on the next executed continuation contact. If the flow of logic does not execute a continuation coil before it executes a continuation contact, the state of the contact will be no flow.

There can be only one continuation coil and contact per rung the continuation contact must be in column 1 and the continuation coil must be in column 10. An example continuation coil and contact are shown below.

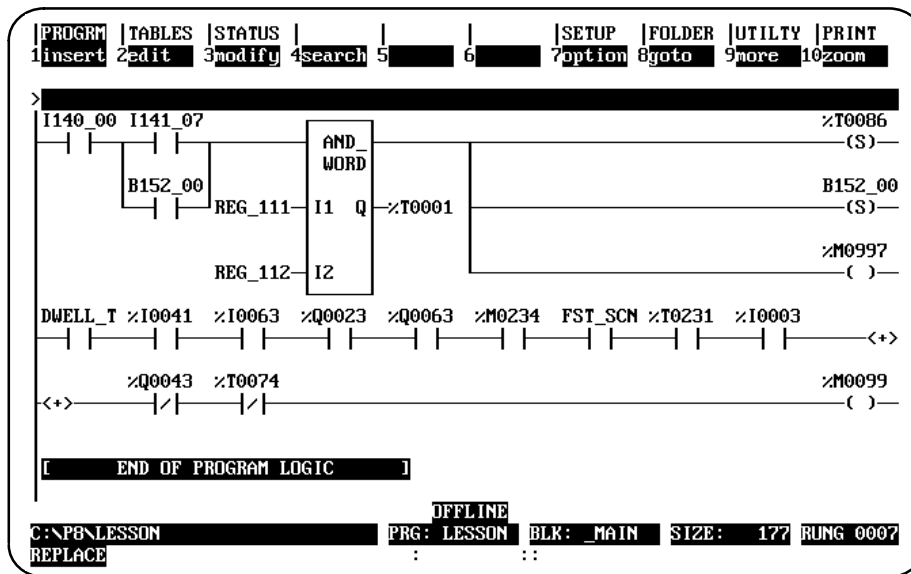

## 2. TIMERS AND COUNTERS

This paragraph explains how to use on-delay and stopwatch-type timers, up counters and down counters. The data associated with these functions is retentive through power cycles.

Abbreviation	Function	Page
ONDTR	Retentive On-Delay Timer	4-10
TMR	Simple On-Delay Timer	4-13
OFDT	Off-Delay Timer	4-15
UPCTR	Up Counter	4-18
DNCTR	Down Counter	4-19

### 2.1. Function Block Data Required for Timers and Counters

Each timer or counter uses three words (registers) of %R memory to store the following information:

current value (CV)	word 1
preset value (PV)	word 2
control word	word 3

When you enter a timer or counter, you must enter a beginning address for these three words (registers) directly below the graphic representing the function. For example:

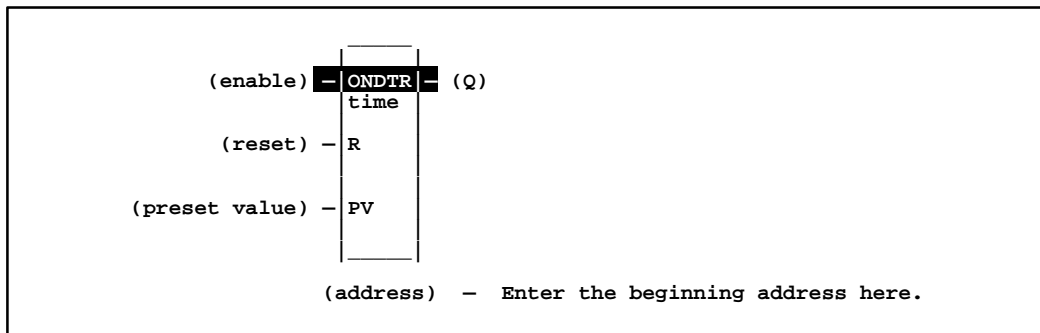

**Note**

Do not use consecutive registers for the 3 word timer/counter blocks. Alspla P8 does *not* check or warn you if register blocks overlap. Timers and counters will not work if you place the current value of a block on top of the preset for the previous block.

The control word stores the state of the boolean inputs and outputs of its associated function block, as shown in the following format:

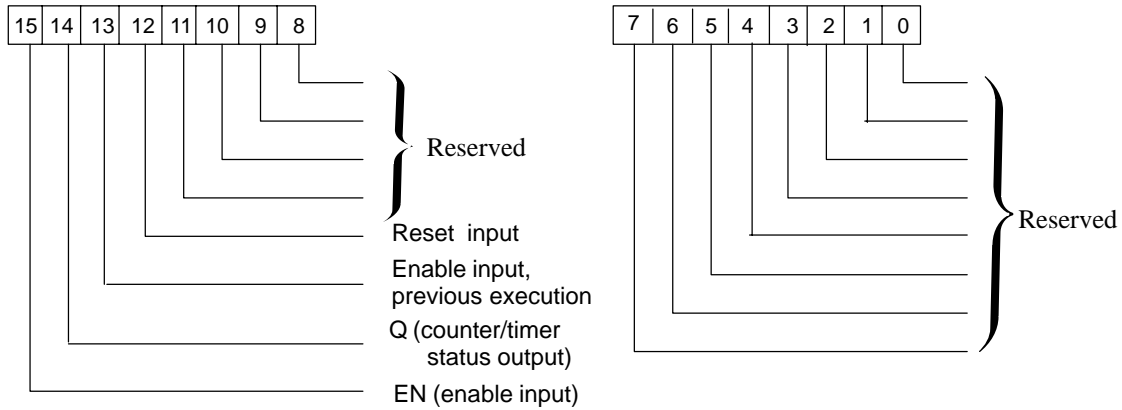

Bits 0 to 13 are used for timer accuracy; bits 0 to 11 are not used for counters.

**Note**

Use care if you use the same address for PV as the second word in the block of three words. If PV is not a constant, the PV is normally set to a different location than the second word. Some applications choose to use the second word address for the PV, such as using %R0102 when the bottom data block starts at %R0101. This allows an application to change the PV while the timer or counter is running. Applications can read the first CV or third Control words, but the application cannot write to these values or the function will not work.

## 2.2. ONDTR

A retentive on–delay timer (ONDTR) increments while it receives power flow and holds its value when power flow stops. Time may be counted in tenths of a second (the default selection), hundredths of a second or thousandths of a second. The range is 0 to +32767 time units. The state of this timer is retentive on power failure no automatic initialization occurs at power–up.

When the ONDTR first receives power flow, it starts accumulating time (current value). When this timer is encountered in the ladder logic, its current value is updated.

**Note**

If multiple occurrences of the same timer with the same reference address are enabled during a CPU sweep, the current values of the timers will be the same.

When the current value equals or exceeds the preset value PV, output Q is energized. As long as the timer continues to receive power flow, it continues accumulating until the maximum value is reached. Once the maximum value is reached, it is retained and output Q remains energized regardless of the state of the enable input.

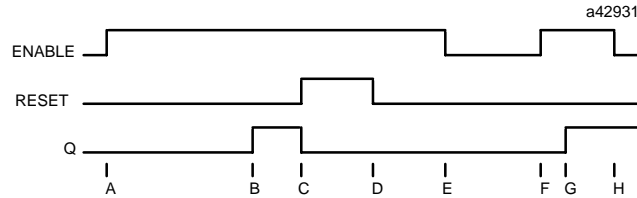

- A = ENABLE goes high; timer starts accumulating.
- B = Current value reaches preset value PV; Q goes high.
- C = RESET goes high; Q goes low, accumulated time is reset.
- D = RESET goes low; timer then starts accumulating again.
- E = ENABLE goes low; timer stops accumulating. Accumulated time stays the same.
- F = ENABLE goes high again; timer continues accumulating time.
- G = Current value becomes equal to preset value PV; Q goes high. Timer continues to accumulate time until ENABLE goes low, RESET goes high or current value becomes equal to the maximum time.
- H = ENABLE goes low; timer stops accumulating time.

When power flow to the timer stops, the current value stops incrementing and is retained. Output Q, if energized, will remain energized. When the function receives power flow again, the current value again increments, beginning at the retained value. When reset R receives power flow, the current value is set back to zero and output Q is de-energized unless PV equals zero.

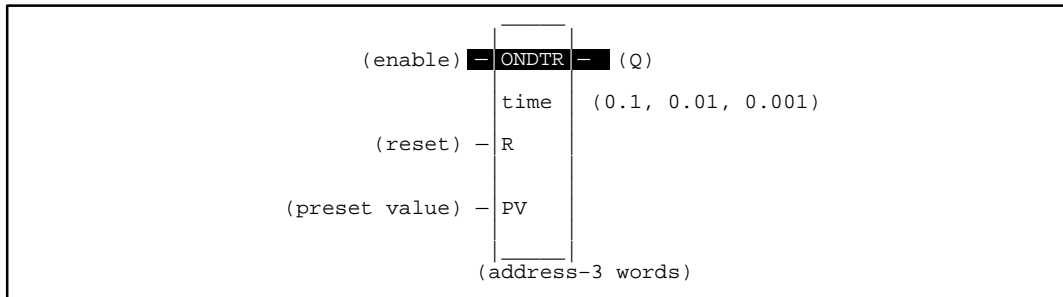

### 2.2.1. Parameters

Parameter	Description
address	<p>The ONDTR uses three consecutive words (registers) of %R memory to store the following:</p> <ul style="list-style-type: none"> <li>• Current value (CV) = word 1.</li> <li>• Preset value (PV) = word 2.</li> <li>• Control word = word 3.</li> </ul> <p>When you enter an ONDTR, you must enter an address for the location of these three consecutive words (registers) directly below the graphic representing the function.</p> <p><b>Note:</b> Do not use this address with other instructions.</p> <p><b>Caution:</b> Overlapping references will result in erratic operation of the timer.</p>
enable	When enable receives power flow, the timer’s current value is incremented.
R	When R receives power flow, it resets the current value to zero.
PV	PV is the value to copy into the timer’s preset value when the timer is enabled or reset.
Q	Output Q is energized when the current value is greater than or equal to the preset value.
time	Time increment is in tenth (0.1), hundredths (0.01) or thousandths (0.001) of seconds for the low bit of the PV preset and CV current value.

### 2.2.2. Valid Memory Types

Parameter	flow	%I	%Q	%M	%T	%S	%G	%R	%AI	%AQ	const	none
address								•				
enable	•											
R	•											
PV		•	•	•	•		•	•	•	•	•	•
Q	•											•

• = Valid reference or place where power may flow through the function.

#### Example:

In the following example, a retentive on–delay timer is used to create a signal (%Q0011) that turns on 8.0 seconds after %Q0010 turns on and turns off when %Q0010 turns off.

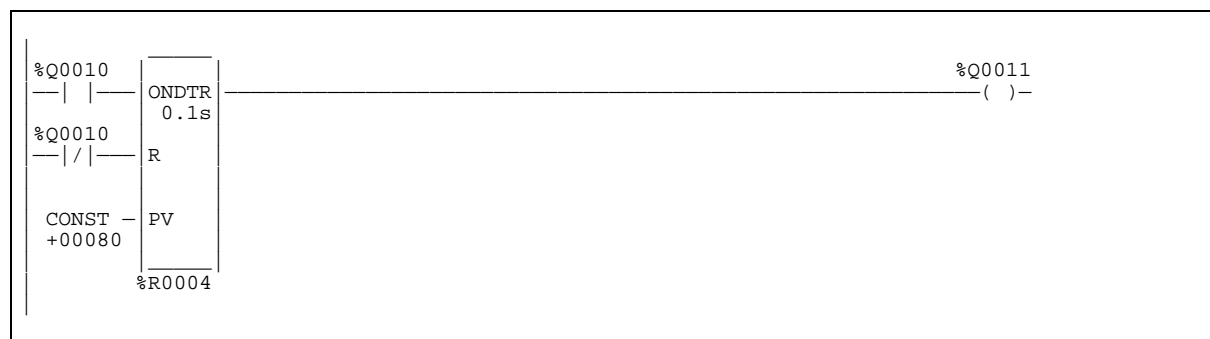

### 2.3. TMR

The simple on-delay timer (TMR) function increments while it receives power flow and resets to zero when power flow stops. Time may be counted in tenths of a second (the default selection), hundredths of a second or thousandths of a second. The range is 0 to +32767 time units. The state of this timer is retentive on power failure no automatic initialization occurs at power-up.

When the TMR receives power flow, the timer starts accumulating time (current value). The current value is updated when it is encountered in the logic to reflect the total elapsed time the timer has been enabled since it was last reset.

**Note**

If multiple occurrences of the same timer with the same reference address are enabled during a CPU sweep, the current values of the timers will be the same.

This update occurs as long as the enabling logic remains ON. When the current value equals or exceeds the preset value PV, the function begins passing power flow to the right. The timer continues accumulating time until the maximum value is reached. When the enabling parameter transitions from ON to OFF, the timer stops accumulating time and the current value is reset to zero.

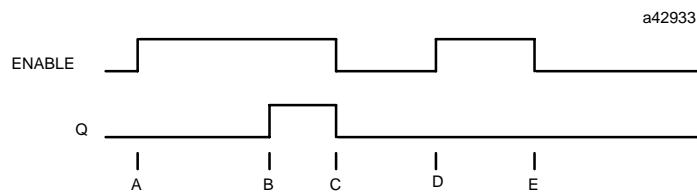

- A = ENABLE goes high; timer begins accumulating time.
- B = Current value reaches preset value PV; Q goes high, and timer continues accumulating time.
- C = ENABLE goes low; Q goes low; timer stops accumulating time and current time is cleared.
- D = ENABLE goes high; timer starts accumulating time.
- E = ENABLE goes low before current value reaches preset value PV; Q remains low; timer stops accumulating time and is cleared to zero.

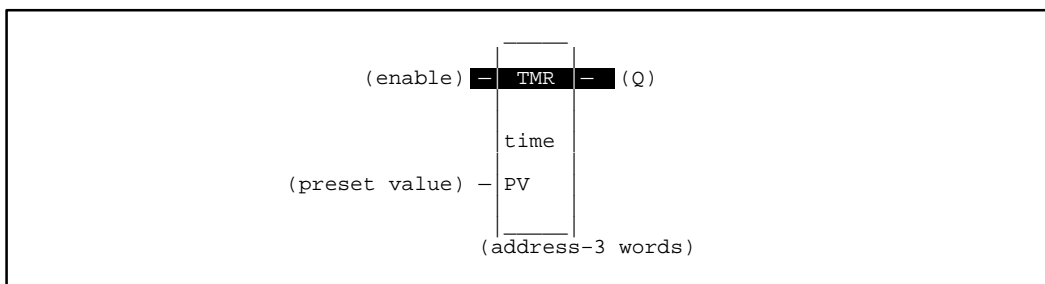

### 2.3.1. Parameters

Parameter	Description
address	<p>The TMR uses three consecutive words (registers) of %R memory to store the following:</p> <ul style="list-style-type: none"> <li>• Current value (CV) = word 1.</li> <li>• Preset value (PV) = word 2.</li> <li>• Control word = word 3.</li> </ul> <p>When you enter an TMR, you must enter an address for the location of these three consecutive words (registers) directly below the graphic representing the function.</p> <p><b>Note:</b> Do not use this address with other instructions.</p> <p><b>Caution:</b> Overlapping references will result in erratic operation of the timer.</p>
enable	When enable receives power flow, the timer’s current value is incremented. When the TMR is not enabled, the current value is reset to zero and Q is turned off.
PV	PV is the value to copy into the timer’s preset value when the timer is enabled or reset.
Q	Output Q is energized when TMR is enabled and the current value is greater than or equal to the preset value.

### 2.3.2. Valid Memory Types

Parameter	flow	%I	%Q	%M	%T	%S	%G	%R	%AI	%AQ	const	none
address								•				
enable	•											
PV		•	•	•	•		•	•	•	•	•	•
Q	•											•

• = Valid reference or place where power may flow through the function.

#### Example:

In the following example, a delay timer (with address) TMRID is used to control the length of time that coil DWELL is on. When the normally open (momentary) contact DO\_DWL is on, coil DWELL is energized. The contact of coil DWELL keeps coil DWELL energized (when contact DO\_DWL is released) and also starts the timer TMRID. When TMRID reaches its preset value of one-half second, coil REL energizes, interrupting the latched-on condition of coil DWELL. The contact DWELL interrupts power flow to TMRID, resetting its current value and de-energizing coil REL. The circuit is then ready for another momentary activation of contact DO\_DWL.

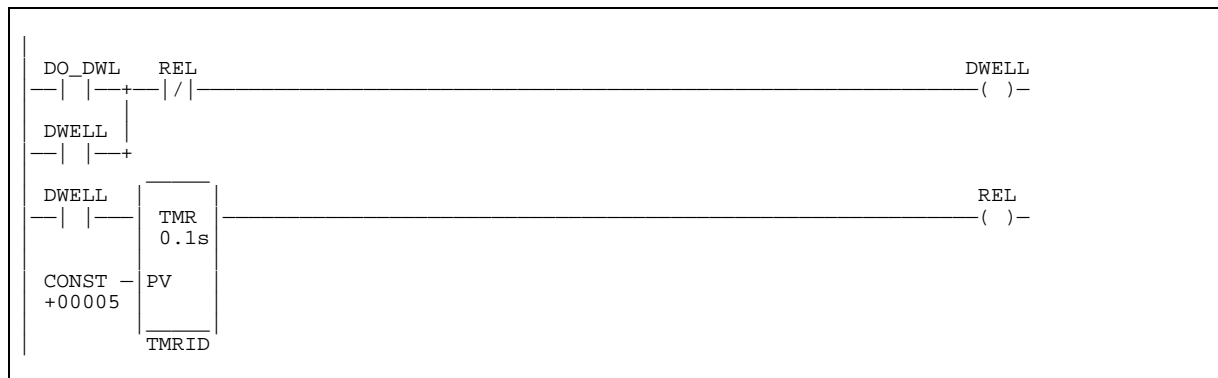

## 2.4. OFDT

The off-delay timer (OFDT) increments while power flow is off, and resets to zero when power flow is on. Time may be counted in tenths of a second (the default selection), hundredths of a second or thousandths of a second. The range is 0 to +32767 time units. The state of this timer is retentive on power failure no automatic initialization occurs at power-up.

When the OFDT first receives power flow, it passes power to the right and the current value (CV) is set to zero. (The OFDT uses word 1 [register] as its CV storage location—see the “Parameters” paragraph on the next page for additional information.) The output remains on as long as the function receives power flow. If the function stops receiving power flow from the left, it continues to pass power to the right and the timer starts accumulating time in the current value.

**Note**

If multiple occurrences of the same timer with the same reference address are enabled during a CPU sweep, the current values of the timers will be the same.

The OFDT does not pass power flow if the preset value is zero or negative.

Each time the function is invoked with the enabling logic set to OFF, the current value is updated to reflect the elapsed time since the timer was turned off. When the current value (CV) is equal to the preset value (PV), the function stops passing power flow to the right. When that occurs, the timer stops accumulating time—see Part C below.

When the function receives power flow again, the current value resets to zero.

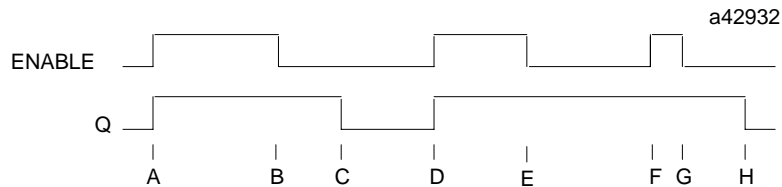

- A = ENABLE and Q both go high; timer is reset (CV = 0).
- B = ENABLE goes low; timer starts accumulating time.
- C = CV reaches PV; Q goes low and timer stops accumulating time.
- D = ENABLE goes high; timer is reset (CV = 0).
- E = ENABLE goes low; timer starts accumulating time.
- F = ENABLE goes high; timer is reset (CV = 0).
- G = ENABLE goes low; timer begins accumulating time.
- H = CV reaches PV; Q goes low and timer stops accumulating time.

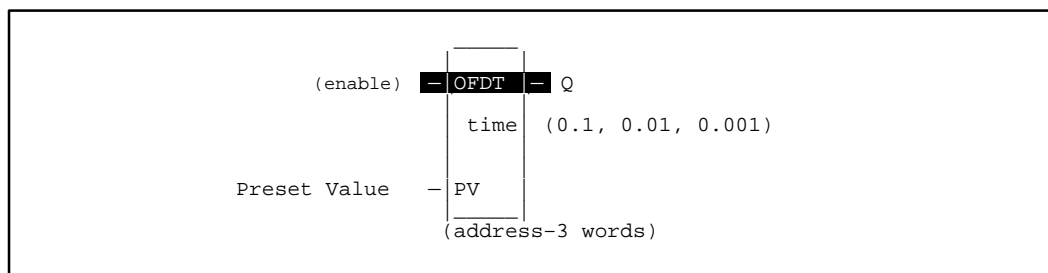

When the OFDT is used in a program block that is *not* called every sweep, the timer accumulates time between calls to the program block unless it is reset. This means that it functions like a timer operating in a program with a much slower sweep than the timer in the main program block. For program blocks that are inactive for a long time, the timer should be programmed to allow for this catch-up feature. For example, if a timer in a program block is reset and the program block is not called (is inactive) for four minutes, when the program block is called, four minutes of time will already have accumulated. This time is applied to the timer when enabled, unless the timer is first reset.

### 2.4.1. Parameters

Parameter	Description
address	The OFDT uses three consecutive words (registers) of %R memory to store the following: <ul style="list-style-type: none"> <li>• Current value (CV) = word 1.</li> <li>• Preset value (PV) = word 2.</li> <li>• Control word = word 3.</li> </ul> When you enter an OFDT, you must enter an address for the location of these three consecutive words (registers) directly below the graphic representing the function.  <b>Note:</b> Do not use this address with other instructions.  <b>Caution:</b> Overlapping references will result in erratic operation of the timer.
enable	When enable receives power flow, the timer's current value is incremented.
time	Time (P1) specifies the type of unit (milliseconds, etc.) the registers are using.
PV	PV is the value to copy into the timer's preset value when the timer is enabled or reset. For a register (%R) PV reference, the PV parameter is specified as the second word of the address parameter. For example, an address parameter of %R00001 would use %R00002 as the PV parameter.
Q	Output Q is energized when the current value is less than the preset value. The Q state is retentive on power failure; no automatic initialization occurs at power-up.

### 2.4.2. Valid Memory Types

Parameter	flow	%I	%Q	%M	%T	%S	%G	%R	%AI	%AQ	const	none
address								•				
enable	•											
PV	•	•	•	•	•		•	•	•	•	•	•
Q	•											•

- Valid reference or place where power may flow through the function.

**Example:**

In the following example, an OFDT timer is used to turn off an output (%Q00001) whenever an input (%I00001) turns on. The output is turned on again 0.3 seconds after the input goes off.

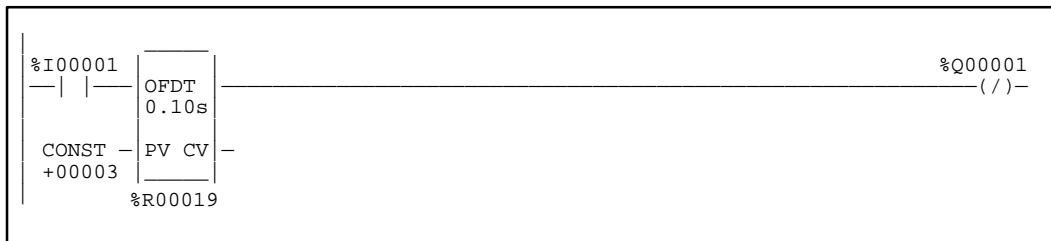

## 2.5. UPCTR

The Up Counter (UPCTR) function is used to count up to a designated value. The range is 0 to +32767 counts. When the up counter reset is ON, the current value of the counter is reset to 0. Each time the enable input transitions from OFF to ON, the current value is incremented by 1. The current value can be incremented past the preset value PV. The output is ON whenever the current value is greater than or equal to the preset value.

The state of the UPCTR is retentive on power failure; no automatic initialization occurs at power-up.

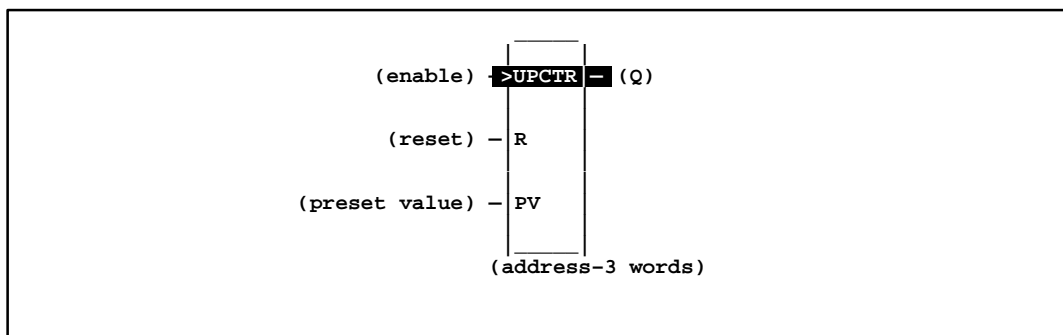

### 2.5.1. Parameters

Parameter	Description
address	<p>The UPCTR uses three consecutive words (registers) of %R memory to store the following:</p> <ul style="list-style-type: none"> <li>• Current value (CV) = word 1.</li> <li>• Preset value (PV) = word 2.</li> <li>• Control word = word 3.</li> </ul> <p>When you enter an UPCTR, you must enter an address for the location of these three consecutive words (registers) directly below the graphic representing the function.</p> <p><b>Note:</b> Do not use this address with another up counter, down counter or any other instruction or improper operation will result.</p> <p><b>Caution:</b> Overlapping references will result in erratic operation of the counter.</p>
enable	On a positive transition of enable, the current count is incremented by one.
R	When R receives power flow, it resets the current value back to zero.
PV	PV is the value to copy into the counter's preset value when the counter is enabled or reset.
Q	Output Q is energized when the current value is greater than or equal to the preset value.

### 2.5.2. Valid Memory Types

Parameter	flow	%I	%Q	%M	%T	%S	%G	%R	%AI	%AQ	const	none
address								•				
enable	•											
R	•											
PV		•	•	•	•		•	•	•	•	•	•
Q	•											•

•= Valid reference or place where power may flow through the function.

**Example:**

In the following example, every time input %I0012 transitions from OFF to ON, up counter PRT\_CNT counts up by 1; internal coil %M0001 is energized whenever 100 parts have been counted. Whenever %M0001 is ON, the accumulated count is reset to zero.



**2.6. DNCTR**

The Down Counter (DNCTR) function is used to count down from a preset value. The minimum preset value is zero; the maximum present value is +32767 counts. The minimum current value is —32768. When reset, the current value of the counter is set to the preset value PV. When the enable input transitions from OFF to ON, the current value is decremented by one. The output is ON whenever the current value is less than or equal to zero.

The current value of the DNCTR is retentive on power failure; no automatic initialization occurs at power-up.

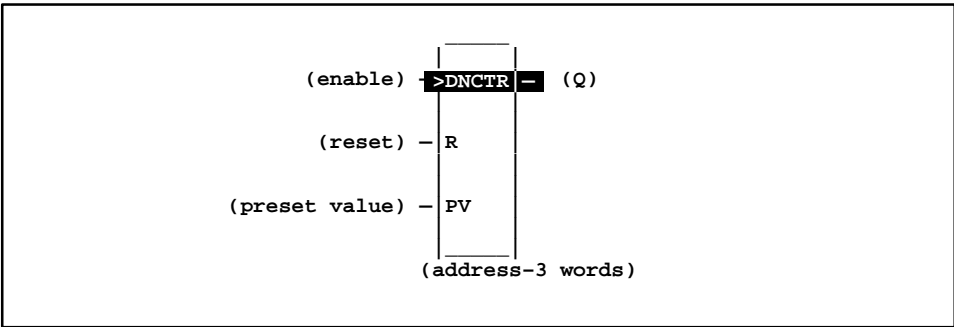

### 2.6.1. Parameters

Parameter	Description
address	<p>The DNCTR uses three consecutive words (registers) of %R memory to store the following:</p> <ul style="list-style-type: none"> <li>• Current value (CV) = word 1.</li> <li>• Preset value (PV) = word 2.</li> <li>• Control word = word 3.</li> </ul> <p>When you enter an DNCTR, you must enter an address for the location of these three consecutive words (registers) directly below the graphic representing the function.</p> <p><b>Note:</b> Do not use this address with another down counter, up counter or any other instruction or improper operation will result.</p> <p><b>Caution:</b> Overlapping references will result in erratic operation of the counter.</p>
enable	On a positive transition of enable, the current value is decremented by one.
R	When R receives power flow, it resets the current value to the preset value.
PV	PV is the value to copy into the counter’s preset value when the counter is enabled or reset.
Q	Output Q is energized when the current value is less than or equal to zero.

### 2.6.2. Valid Memory Types

Parameter	flow	%I	%Q	%M	%T	%S	%G	%R	%AI	%AQ	const	none
address								•				
enable	•											
R	•											
PV		•	•	•	•		•	•	•	•	•	•
Q	•											•

•= Valid reference or place where power may flow through the function.

**Example:**

In the following example, the down counter identified as COUNTP counts 500 new parts before energizing output %Q0005.

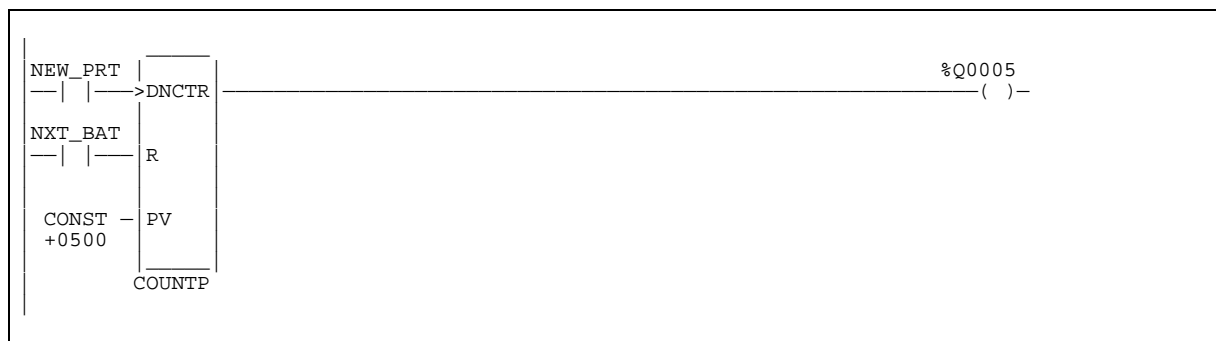

**Example:**

In the following example, the PLC is used to keep track of the number of parts contained in a temporary storage area. There are two ways of accomplishing this function using the Alspa P8-25/35/05 instruction set.

The first method is to use an up/down counter pair with a shared register for the accumulated or current value. When the parts enter the storage area, the up counter increments by 1, increasing the current value of the parts in storage by a value of 1. When a part leaves the storage area, the down counter decrements by 1, decreasing the inventory storage value by 1. To avoid conflict with the shared register, both counters use different register addresses. When a register counts, its current value must be moved to the current value register of the other counter.

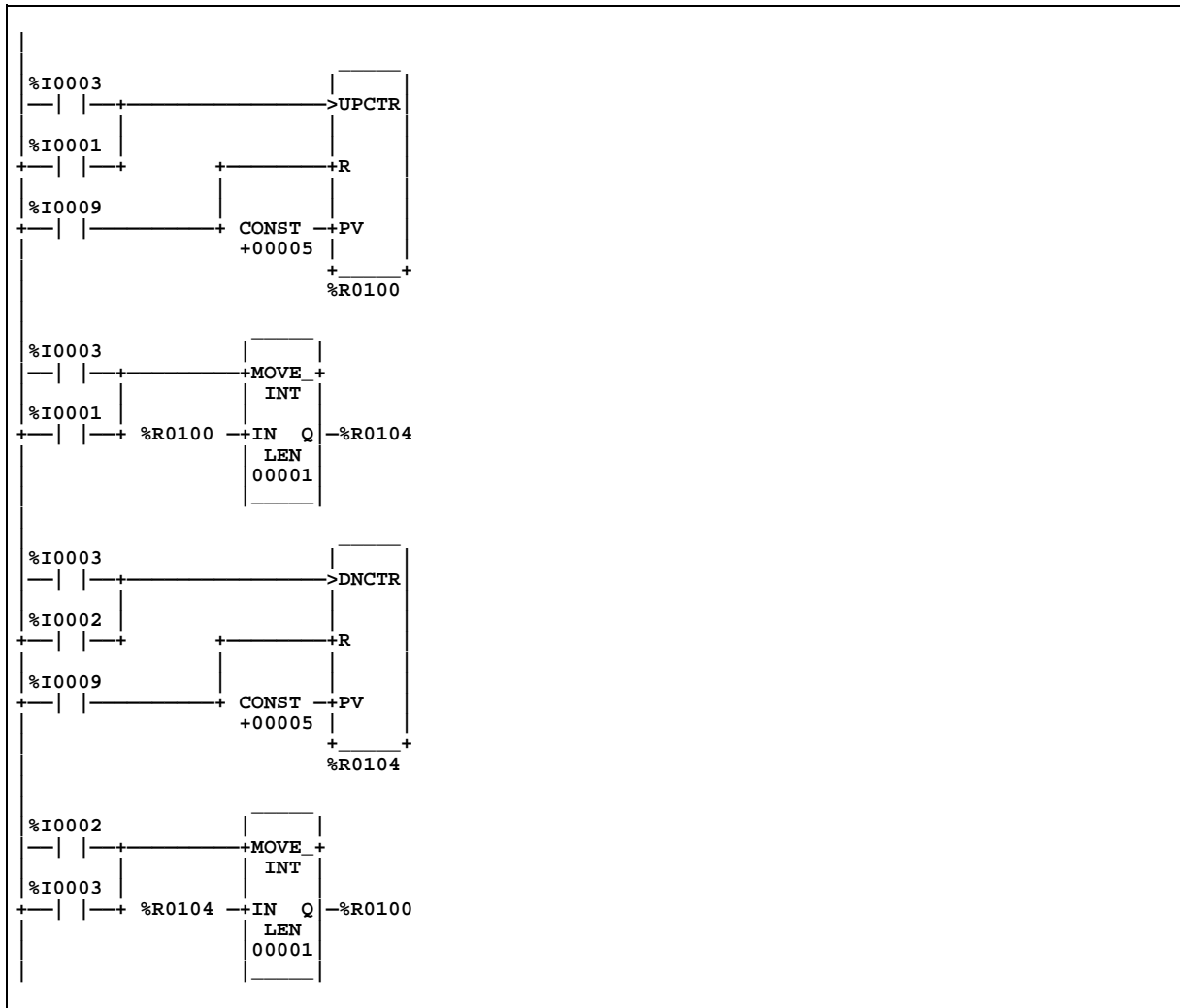

The second method, shown below, uses the ADD and SUB functions to provide storage tracking.

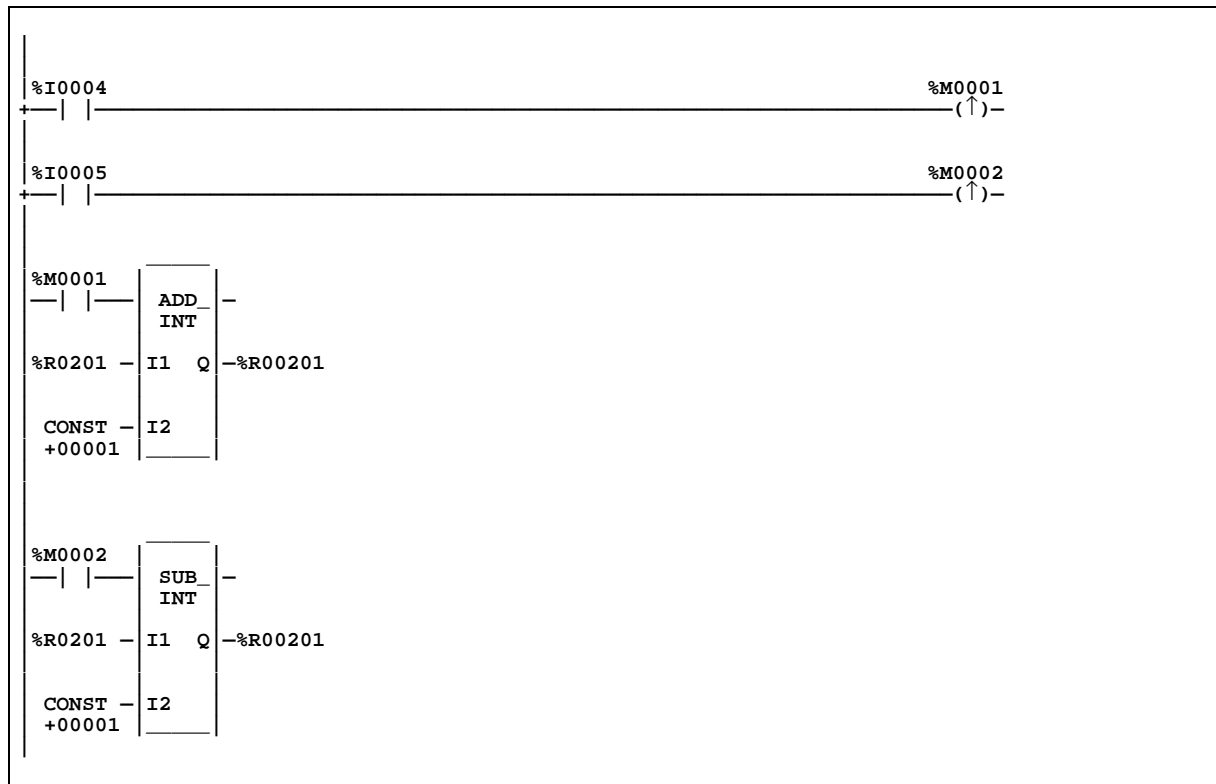

### 3. MATH FUNCTIONS

This paragraph describes the math functions of the Alspla P8–25/35/05 Instruction Set:

Abbreviation	Function	Description	Page
ADD	Addition	Add two numbers.	4–23
SUB	Subtraction	Subtract one number from another.	4–23
MUL	Multiplication	Multiply two numbers.	4–23
DIV	Division	Divide one number by another, yielding a quotient.	4–23
MOD	Modulo Division	Divide one number by another, yielding a remainder.	4–27
SQRT	Square Root	Find the square root of an integer or real value.	4–29
SIN, COS, TAN, ASIN, ACOS, ATAN	Trigonometric Functions *	Perform the appropriate function on the real value in input IN.	4–30
LOG, LN EXP, EXPT	Logarithmic/Exponential Functions *	Perform the appropriate function on the real value in input IN.	4–32
RAD, DEG	Radian Conversion *	Perform the appropriate function on the real value in input IN.	4–34

\* Trigonometric Functions, Logarithmic/Exponential Functions and Radian Conversion functions are only available on the model 352 CPU.

**Note**

Division and modulo division are similar functions which differ in their output; division finds a quotient, while modulo division finds a remainder.

#### 3.1. Standard Math Functions (ADD, SUB, MUL, DIV)

Math functions include addition, subtraction, multiplication and division. When a function receives power flow, the appropriate math function is performed on input parameters I1 and I2. These parameters must be the same data type. Output Q is the same data type as I1 and I2.

**Note**

DIV rounds down; it does not round to the closest integer. (For example, 24 DIV 5 = 4).

Math functions operate on these types of data:

Data Type	Description
INT	Signed integer.
DINT	Double precision signed integer.
REAL	Floating Point

**Note**

The REAL data type is only available on 352 CPUs.

The default data type is signed integer; however, it can be changed after selecting the function. For more information on data types, please refer to chapter 2, § 2., *Program Organization and User References/Data*.

If the operation results in overflow, the output reference is set to its largest possible value for the data type. For signed numbers, the sign is set to show the direction of the overflow. If the operation does not result in overflow, the ok output is set ON; otherwise, it is set OFF.

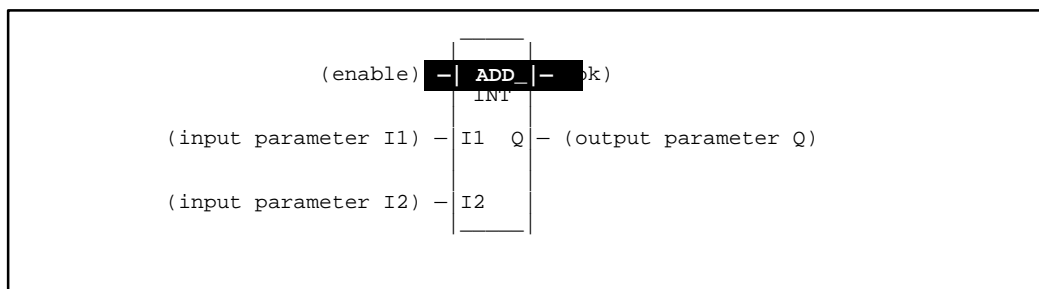

### 3.1.1. Parameters

Parameter	Description
enable	When the function is enabled, the operation is performed.
I1	I1 contains a constant or reference for the first value used in the operation. (I1 is on the left side of the mathematical equation, as in I1 — I2).
I2	I2 contains a constant or reference for the second value used in the operation. (I2 is on the right side of the mathematical equation, as in I1 — I2).
ok	The ok output is energized when the function is performed without overflow, unless an invalid operation occurs.
Q	Output Q contains the result of the operation.

### 3.1.2. Valid Memory Types

Parameter	flow	%I	%Q	%M	%T	%S	%G	%R	%AI	%AQ	const	none
enable	•											
I1		o	o	o	o		o	•	•	•	•†	
I2		o	o	o	o		o	•	•	•	•†	
ok	•											•
Q		o	o	o	o		o	•	•	•		

- = Valid reference or place where power may flow through the function.
- o = Valid reference for INT data only; not valid for DINT or REAL.
- † = Constants are limited to values between —32768 and +32767 for double precision signed integer operations.

#### Note

The default type is INT for 16-bit or single register operands. Press **F10** to change the Types selection to DINT, 32-bit double word or REAL (for the CPU352 only). PLC INT values occupy a single 16-bit register, %R, %AI or %AQ. DINT values require two consecutive registers with the low 16 bits in the first word and the upper 16 bits with the sign in second word. REAL values, in the CPU352 only, also occupy a 32-bit double register with the sign in the high bit followed by the exponent and mantissa.

**Example:**

In the following example, whenever input %I0001 is set, the integer content of %R0002 is decremented by 1 and coil %Q0001 is turned on, provided there is no overflow in the subtraction.

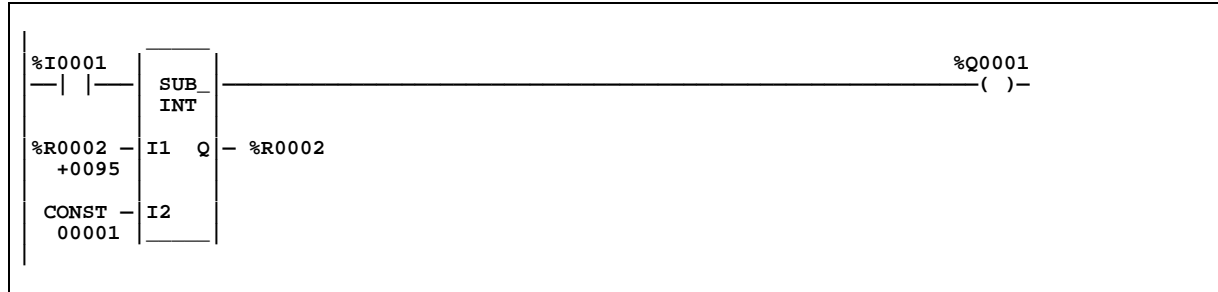

**3.1.3. Math Functions and Data Types**

Function	Operation	Displays as
ADD INT	$Q(16 \text{ bit}) = I1(16 \text{ bit}) + I2(16 \text{ bit})$	5-digit base 10 number with sign
ADD DINT	$Q(32 \text{ bit}) = I1(32 \text{ bit}) + I2(32 \text{ bit})$	8-digit base 10 number with sign
ADD REAL*	$Q(32 \text{ bit}) = I1(32 \text{ bit}) + I2(32 \text{ bit})$	7-digit base 10 number, sign and decimal
SUB INT	$Q(16 \text{ bit}) = I1(16 \text{ bit}) - I2(16 \text{ bit})$	5-digit base 10 number with sign
SUB DINT	$Q(32 \text{ bit}) = I1(32 \text{ bit}) - I2(32 \text{ bit})$	8-digit base 10 number with sign
SUB REAL*	$Q(32 \text{ bit}) = I1(32 \text{ bit}) - I2(32 \text{ bit})$	7-digit base 10 number, sign and decimal
MUL INT	$Q(16 \text{ bit}) = I1(16 \text{ bit}) * I2(16 \text{ bit})$	5-digit base 10 number with sign
MUL DINT	$Q(32 \text{ bit}) = I1(32 \text{ bit}) * I2(32 \text{ bit})$	8-digit base 10 number with sign
MUL REAL*	$Q(32 \text{ bit}) = I1(32 \text{ bit}) * I2(32 \text{ bit})$	7-digit base 10 number, sign and decimal
DIV INT	$Q(16 \text{ bit}) = I1(16 \text{ bit}) / I2(16 \text{ bit})$	5-digit base 10 number with sign
DIV DINT	$Q(32 \text{ bit}) = I1(32 \text{ bit}) / I2(32 \text{ bit})$	8-digit base 10 number with sign
DIV REAL*	$Q(32 \text{ bit}) = I1(32 \text{ bit}) / I2(32 \text{ bit})$	7-digit base 10 number, sign and decimal

\* 352 CPUs only

**Note**

The input and output data types must be the same. The MUL and DIV functions do not support a mixed mode as the C80-75 PLCs do. For example, the MUL INT of 2 16-bit inputs produces a 16-bit product, not a 32-bit product. Using MUL DINT for a 32-bit product requires both inputs to be 32-bit. The DIV INT divides a 16-bit I2 for a 16-bit result while DIV DINT divides a 32-bit I1 by 32-bit I2 for a 32-bit result.

These functions pass power if there is no math overflow. If an overflow occurs, the result is the largest value with the proper sign and no power flow.

Be careful to avoid overflows when using MUL and DIV functions. If you have to convert INT to DINT values, remember that the CPU uses standard 2's complement with the sign extended to the highest bit of the second word.

You must check the sign of the low 16 bit word and extend it into the second 16 bit word. If the most significant bit in a 16-bit INT word is 0 (positive), move a 0 to the second word. If the most significant bit in a 16-bit word is -1 (negative), move a -1 or hex 0FFFFh to the second word. Converting from DINT to INT is easier as the low 16 bit word (first register) is the INT part of a DINT 32 bit word. The upper 16 bits or second word should be either a 0 (positive) or -1 (negative) value or the DINT number is too big to convert to 16 bit.

A common application is to scale analog input values with a MUL operation followed by an DIV and possible an ADD operation. With a range up to 32000, using a MUL INT will overflow. Using an %AI value for a MUL DINT will also not work as the 32 bit I1 will combine 2 analog inputs at the same time. You must move the analog input to the low word of a double register, then test the sign and set the second register to 0 if positive or -1 if it was negative. Use the double register with the MUL DINT for a 32 product for the following DIV function. For example, the following logic could be used to scale a +/-10 volt input %AI1 to +/- 25000 engineering units in %R5.

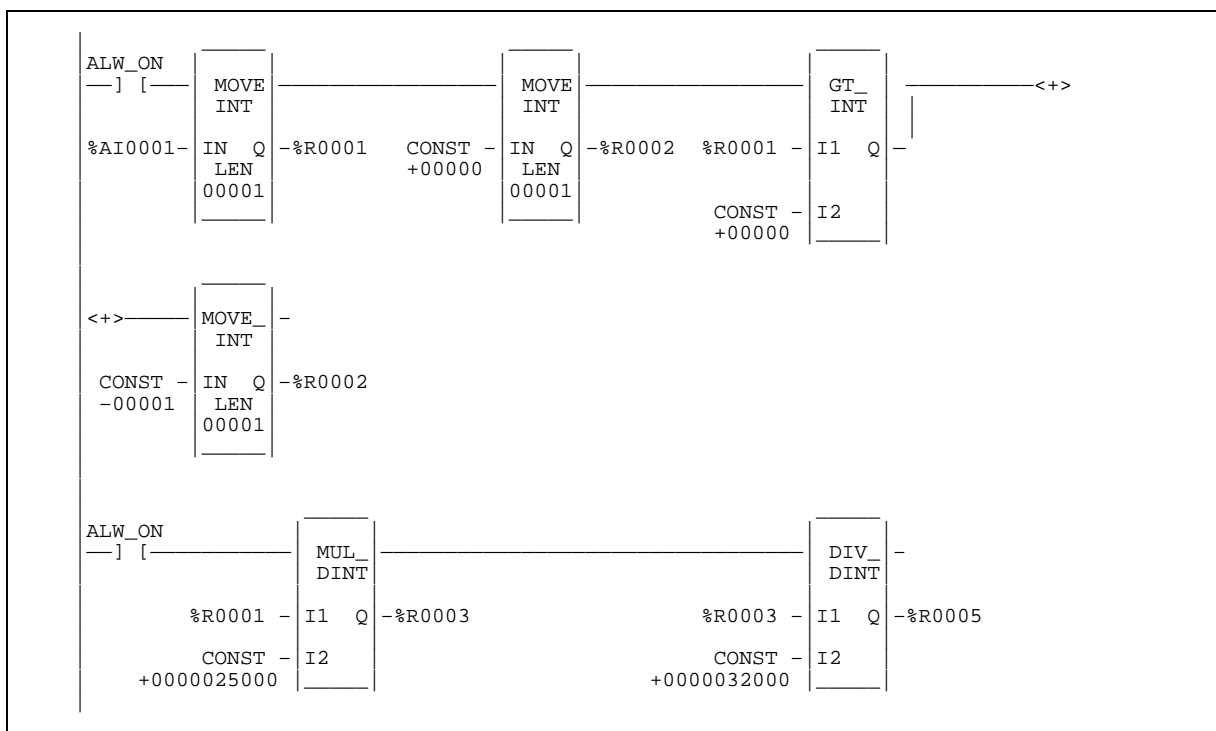

### 3.2. MOD (INT, DINT)

The Modulo (MOD) function is used to divide one value by another value of the same data type, to obtain the remainder. The sign of the result is always the same as the sign of input parameter I1.

The MOD function operates on these types of data:

Data Type	Description
INT	Signed integer.
DINT	Double precision signed integer.

The default data type is signed integer; however, it can be changed after selecting the function. For more information on data types, please refer to chapter 2, § 2., *Program Organization and User References/Data*.

When the function receives power flow, it divides input parameter I1 by input parameter I2. These parameters must be the same data type. Output Q is calculated using the formula:

$$Q = I1 - ((I1 \text{ DIV } I2) * I2)$$

where DIV produces an integer number. Q is the same data type as input parameters I1 and I2.

OK is always ON when the function receives power flow, unless there is an attempt to divide by zero. In that case, it is set OFF.

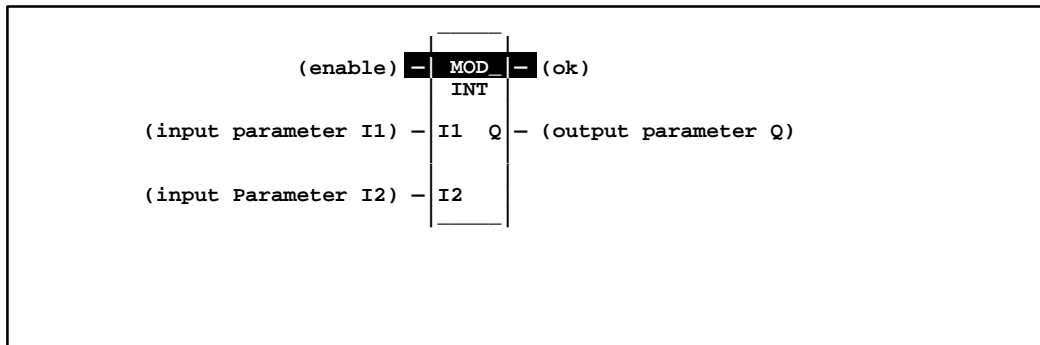

#### 3.2.1. Parameters

Parameter	Description
enable	When the function is enabled, the operation is performed.
I1	I1 contains a constant or reference for the value to be divided by I2.
I2	I2 contains a constant or reference for the value to be divided into I1.
ok	The ok output is energized when the function is performed without overflow.
Q	Output Q contains the result of dividing I1 by I2 to obtain a remainder.

### 3.2.2. Valid Memory Types

Parameter	flow	%I	%Q	%M	%T	%S	%G	%R	%AI	%AQ	const	none
enable	•											
I1		o	o	o	o		o	•	•	•	•†	
I2		o	o	o	o		o	•	•	•	•†	
ok	•											•
Q		o	o	o	o		o	•	•	•		

- = Valid reference or place where power may flow through the function.
- o = Valid reference for INT data only; not valid for DINT.
- † = Constants are limited to values between —32768 and +32767 for double precision signed integer operations.

#### Example:

In the following example, the remainder of the integer division of BOXES into PALLETS is placed into NT\_FULL whenever %I0001 is ON.



### 3.3. SQRT (INT, DINT)

The Square Root (SQRT) function is used to find the square root of a value. When the function receives power flow, the value of output Q is set to the integer portion of the square root of the input IN. The output Q must be the same data type as IN.

The SQRT function operates on these types of data:

Data Type	Description
INT	Signed integer.
DINT	Double precision signed integer.
REAL	Floating Point.

**Note**

The REAL data type is only available on 352 CPUs.

The default data type is signed integer; however, it can be changed after selecting the function. For more information on data types, please refer to chapter 2, § 2., *Program Organization and User References/Data*.

OK is set ON if the function is performed without overflow, unless one of the invalid REAL operations occurs:

- IN < 0,
- IN is NaN (Not a Number).

Otherwise, OK is set to OFF.

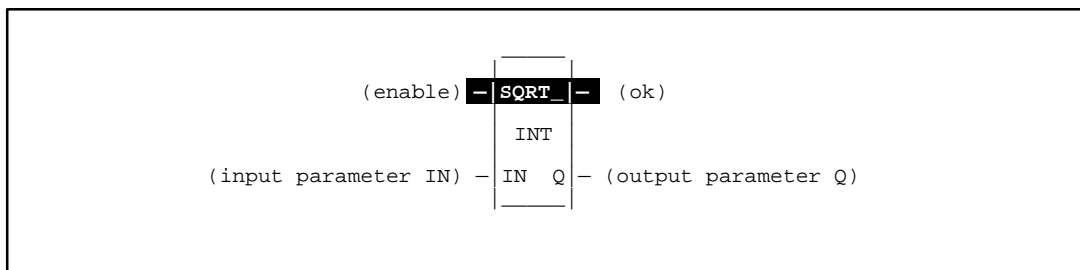

#### 3.3.1. Parameters

Parameter	Description
enable	When the function is enabled, the operation is performed.
IN	IN contains a constant or reference for the value whose square root is to be calculated. If IN is less than zero, the function will not pass power flow.
ok	The ok output is energized when the function is performed without overflow, unless an invalid operation occurs.
Q	Output Q contains the square root of IN.

### 3.3.2. Valid Memory Types

Parameter	flow	%I	%Q	%M	%T	%S	%G	%R	%AI	%AQ	const	none
enable	•											
IN		o	o	o	o		o	•	•	•	•†	
ok	•											•
Q		o	o	o	o		o	•	•	•		

- = Valid reference or place where power may flow through the function.
- o = Valid reference for INT data only; not valid for DINT or REAL.
- † = Constants are limited to values between —32768 and +32767 for double precision signed integer operations.

#### Example:

In the following example, the square root of the integer number located at %AI001 is placed into the result located at %R0003 whenever %I0001 is ON.



### 3.4. Trig Function (SIN, COS, TAN, ASIN, ACOS, ATAN)

The SIN, COS and TAN functions are used to find the trigonometric sine, cosine and tangent respectively of its input. When one of these functions receives power flow, it computes the sine (or cosine or tangent) of IN, whose units are radians and stores the result in output Q. Both IN and Q are floating-point values.

The ASIN, ACOS and ATAN functions are used to find the inverse sine, cosine and tangent respectively of its input. When one of these functions receives power flow, it computes the inverse sine (or cosine or tangent) of IN and stores the result in output Q, whose units are radians. Both IN and Q are floating-point values.

The SIN, COS and TAN functions accept a broad range of input values, where  $-2^{63} < IN < +2^{63}$ , ( $2^{63} \approx 9.22 \times 10^{18}$ ).

The ASIN and ACOS functions accept a narrow range of input values, where  $-1 \leq IN \leq 1$ . Given a valid value for the IN parameter, the ASIN\_REAL function will produce a result Q such that:

$$\text{ASIN (IN)} = -\frac{\pi}{2} \leq Q \leq \frac{\pi}{2}$$

The ACOS\_REAL function will produce a result Q such that:

$$\text{ACOS (IN)} = 0 \leq Q \leq \pi$$

The ATAN function accepts the broadest range of input values, where  $-\infty \leq IN \leq +\infty$ . Given a valid value for the IN parameter, the ATAN\_REAL function will produce a result Q such that:

$$\text{ATAN (IN)} = -\frac{\pi}{2} \leq Q \leq \frac{\pi}{2}$$

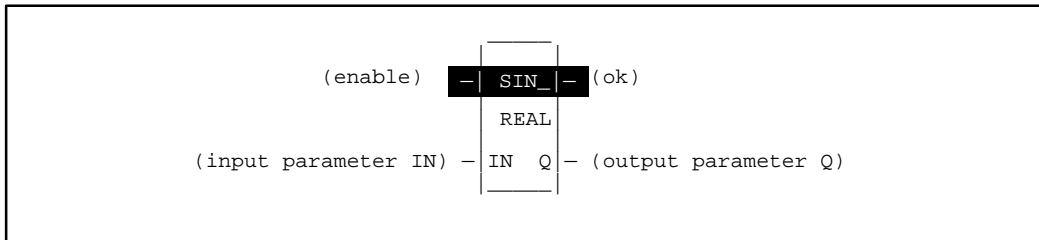

**Note**

The TRIG functions are only available on the model 352 CPU.

### 3.4.1. Parameters

Parameter	Description
enable	When the function is enabled, the operation is performed.
IN	IN contains the constant or reference real value to be operated on.
ok	The ok output is energized when the function is performed without overflow, unless an invalid operation occurs and/or IN is NaN.
Q	Output Q contains the trigonometric value of IN.

### 3.4.2. Valid Memory Types

Parameter	flow	%I	%Q	%M	%T	%S	%G	%R	%AI	%AQ	const	none
enable	•											
IN								•	•	•	•	
ok	•											•
Q								•	•	•		

- Valid reference or place where power may flow through the function.

**Example:**

In the following example, the COS of the value in %R0001 is placed in %R0033.

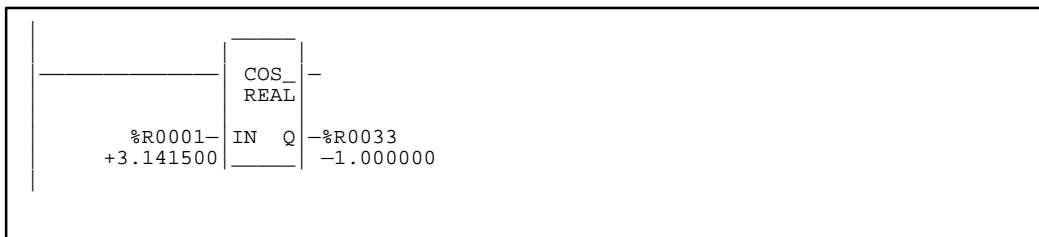

### 3.5. Logarithmic/Exponential Functions (LOG, LN, EXP, EXPT)

The LOG, LN and EXP functions have two input parameters and two output parameters. When the function receives power flow, it performs the appropriate logarithmic/exponential operation on the real value in input IN and places the result in output Q.

- For the LOG function, the base 10 logarithm of IN is placed in Q.
- For the LN function, the natural logarithm of IN is placed in Q.
- For the EXP function,  $e$  is raised to the power specified by IN and the result is placed in Q.
- For the EXPT function, the value of input I1 is raised to the power specified by the value I2 and the result is placed in output Q. (The EXPT function has three input parameters and two output parameters.)

The ok output will receive power flow, unless IN is NaN (Not a Number) or is negative.

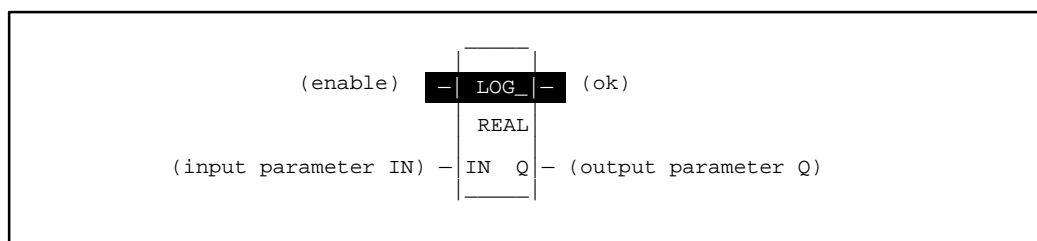

#### 3.5.1. Parameters

Parameter	Description
enable	When the function is enabled, the operation is performed.
IN	IN contains the real value to be operated on.
ok	The ok output is energized when the function is performed without overflow, unless an invalid operation occurs and/or IN is NaN or is negative.
Q	Output Q contains the logarithmic/exponential value of IN.

#### Note

The LOG, LN, EXP and EXPT functions are only available on the model 352 CPU.

### 3.5.2. Valid Memory Types

Parameter	flow	%I	%Q	%M	%T	%S	%G	%R	%AI	%AQ	const	none
enable	•											
IN*								•	•	•	•	
ok	•											•
Q								•	•	•		

\* For the EXPT function, input IN is replaced by input parameters I1 and I2.

- Valid reference or place where power may flow through the function.

#### Example:

In the following example, the value of %AI001 is raised to the power of 2.5 and the result is placed in %R0001.

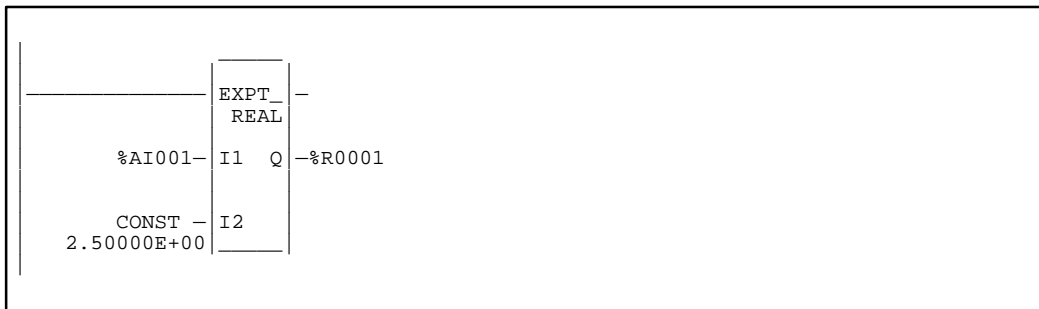

### 3.6. Radian Conversion (RAD, DEG)

When the function receives power flow, the appropriate conversion (RAD\_TO\_DEG or DEG\_TO\_RAD, i.e., Radian to Degree or vice versa) is performed on the real value in input IN and the result is placed in output Q.

The ok output will receive power flow unless IN is NaN (Not a Number).

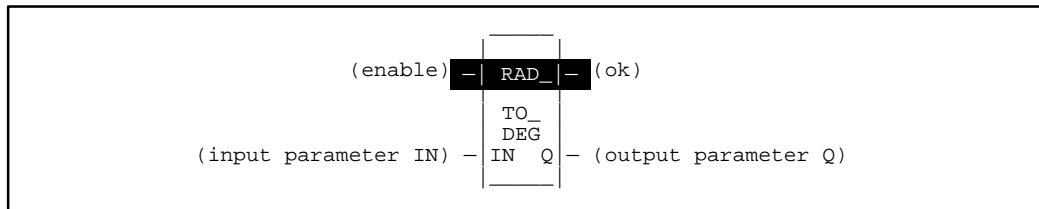

#### 3.6.1. Parameters

Parameter	Description
enable	When the function is enabled, the operation is performed.
IN	IN contains the real value to be operated on.
ok	The ok output is energized when the function is performed without overflow, unless IN is NaN.
Q	Output Q contains the converted value of IN.

**Note**

The Radian conversion functions are only available on the 352 CPU.

#### 3.6.2. Valid Memory Types

Parameter	flow	%I	%Q	%M	%T	%S	%G	%R	%AI	%AQ	const	none
enable	•											
IN								•	•	•	•	
ok	•											•
Q								•	•	•		

- Valid reference or place where power may flow through the function.

**Example:**

In the following example, +1500 is converted to DEG and is placed in %R0001.



## 4. RELATIONAL FUNCTIONS

### 4.1. Comparisons

Relational functions are used to compare two numbers. This paragraph describes the following relational functions:

Abbreviation	Function	Description	Page
EQ	Equal	Test two numbers for equality.	4–35
NE	Not Equal	Test two numbers for non–equality.	4–35
GT	Greater Than	Test for one number greater than another.	4–35
GE	Greater Than or Equal	Test for one number greater than or equal to another.	4–35
LT	Less Than	Test for one number less than another.	4–35
LE	Less Than or Equal	Test for one number less than or equal to another.	4–35
RANGE	Range	Determine whether a number is within a specified range (available for Release 4.5 or higher CPUs) .	4–37

Relational functions are used to determine the relation of two values. When the function receives power flow, it compares input parameter I1 to input parameter I2. These parameters must be the same data type.

Relational functions operate on these types of data:

Data Type	Description
INT	Signed integer.
DINT	Double precision signed integer.
REAL	Floating point

**Note**

The REAL data type is only available on the 352 CPU. Also, the Range function block does not accept REAL type. Additionally, the %S0020 bit is set ON when a relational function using REAL data executes successfully. It is cleared when either input is NaN (Not a Number).

The default data type is signed integer. To compare either signed integers, double precision signed integers or real numbers, select the new data type after selecting the relational function. To compare data of other types or of two different types, first use the appropriate conversion function (described in § 8., *Conversion Functions*) to change the data to one of the integer types.

If input parameters I1 and I2 match the specified relation, output Q receives power flow and is set ON (1); otherwise, it is set OFF (0).

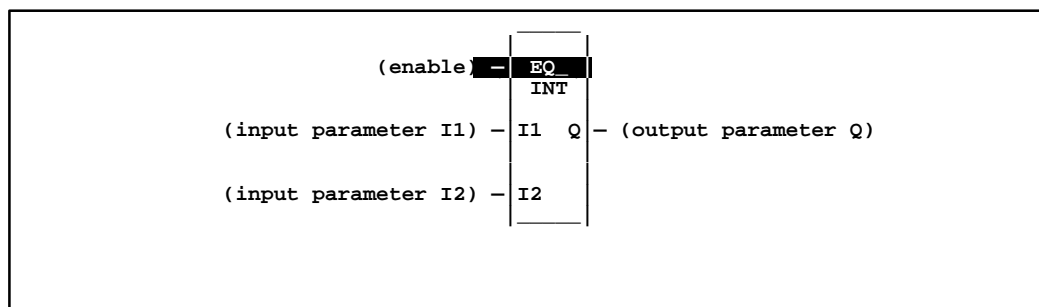

### 4.1.1. Parameters

Parameter	Description
enable	When the function is enabled, the operation is performed.
I1	I1 contains a constant or reference for the first value to be compared. (I1 is on the left side of the relational equation, as in I1 < I2).
I2	I2 contains a constant or reference for the second value to be compared. (I2 is on the right side of the relational equation, as in I1 < I2).
Q	Output Q is energized when I1 and I2 match the specified relation.

**Note**

I1 and I2 must be valid numbers, i.e., cannot be NaN (Not a Number).

### 4.1.2. Valid Memory Types

Parameter	flow	%I	%Q	%M	%T	%S	%G	%R	%AI	%AQ	const	none
enable	•											
I1		o	o	o	o		o	•	•	•	•‡	
I2		o	o	o	o		o	•	•	•	•‡	
Q	•											•

- = Valid reference or place where power may flow through the function.
- o = Valid reference for INT data only; not valid for DINT or REAL.
- ‡ = Constants are limited to integer values for double precision signed integer operations.

**Example:**

In the following example, two double precision signed integers, PWR\_MDE and BIN\_FUL are compared whenever %I0001 is set. If PWR\_MDE is less than or equal to BIN\_FUL, coil %Q0002 is turned on.

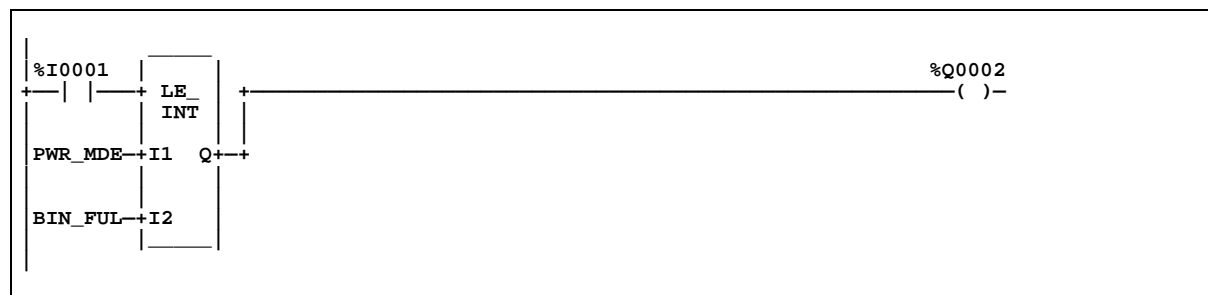

## 4.2. RANGE (INT, DINT, WORD, DWORD)

The RANGE function is used to determine if a value is between the range of two numbers.

**Note**

**This function is available only for Release 4.41 or later CPUs.**

The RANGE function operates on these types of data:

Data Type	Description
INT	Signed integer.
DINT	Double precision signed integer.
WORD	Word data type.

The default data type is signed integer; however, it can be changed after selecting the function. For more information on data types, please refer to chapter 2, § 2., *Program Organization and User References/Data*.

When the function is enabled, the RANGE function block will compare the value in input parameter IN against the range specified by limit parameters L1 and L2. When the value is within the range specified by L1 and L2, inclusive, output parameter Q is set ON (1). Otherwise, Q is set OFF (0).

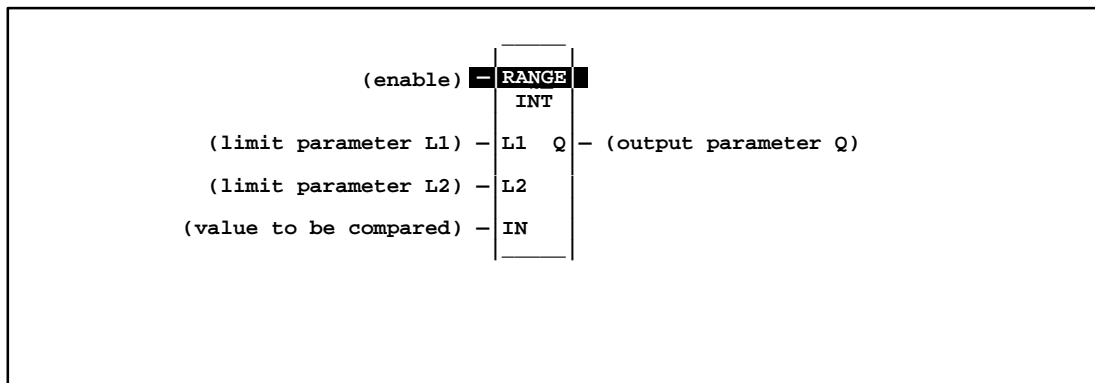

**Note**

Limit parameters L1 and L2 represent the end points of a range. There is no minimum/maximum or high/low connotation assigned to either parameter. Thus, a desired range of 0 to 100 could be specified by assigning 0 to L1 and 100 to L2 or 0 to L2 and 100 to L1.

### 4.2.1. Parameters

Parameter	Description
enable	When the function is enabled, the operation is performed.
L1	L1 contains the start point of the range.
L2	L2 contains the end point of the range.
IN	IN contains the value to be compared against the range specified by L1 and L2.
Q	Output Q is energized when the value in IN is within the range specified by L1 and L2, inclusive.

### 4.2.2. Valid Memory Types

Parameter	flow	%I	%Q	%M	%T	%S	%G	%R	%AI	%AQ	const	none
enable	•											
L1		o	o	o	o		o	•	•	•	•‡	
L2		o	o	o	o		o	•	•	•	•‡	
IN		o	o	o	o		o	•	•	•		
Q	•											•

- = Valid reference or place where power may flow through the function.
- o = Valid reference for INT or WORD data only; not valid for DINT.
- ‡ = Constants are limited to integer values for double precision signed integer operations.

#### Example 1:

In the following example, %AI001 is checked to be within a range specified by two constants, 0 and 100.



RANGE Truth Table				
Enable State %I0001	L1 Value Constant	L2 Value Constant	IN Value %AI001	Q State %Q0001
ON	100	0	< 0	OFF
ON	100	0	0 — 100	ON
ON	100	0	> 100	OFF
OFF	100	0	Not Applicable	OFF

**Example 2:**

In this example, %AI001 is checked to be within a range specified by two register values.

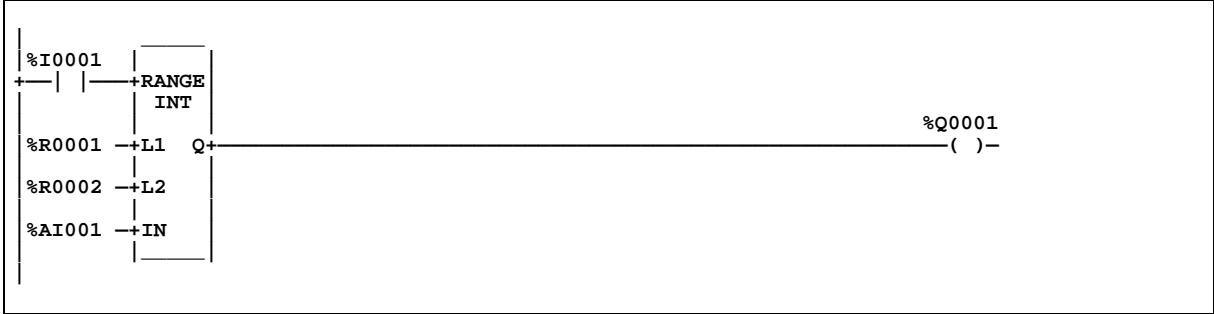

RANGE Truth Table				
Enable State %I0001	L1 Value %R0001	L2 Value %R0002	IN Value %AI001	Q State %Q0001
ON	500	0	< 0	OFF
ON	500	0	0 — 500	ON
ON	500	0	> 500	OFF
OFF	500	0	Not Applicable	

## 5. BIT OPERATION FUNCTIONS

Bit operation functions perform comparison, logical and move operations on bit strings. The AND, OR, XOR and NOT functions operate on a single word. The remaining bit operation functions may operate on multiple words with a maximum string length of 256 words. All bit operation functions require WORD data.

Although data must be specified in 16-bit increments, these functions operate on data as a continuous string of bits, with bit 1 of the first word being the Least Significant Bit (LSB). The last bit of the last word is the Most Significant Bit (MSB). For example, if you specified three words of data beginning at reference %R0100, it would be operated on as 48 contiguous bits.

%R0100	16	15	14	13	12	11	10	9	8	7	6	5	4	3	2	1	← bit 1 (LSB)
%R0101	32	31	30	29	28	27	26	25	24	23	22	21	20	19	18	17	
%R0102	48	47	46	45	44	43	42	41	40	39	38	37	36	35	34	33	
	↑																
	(MSB)																

**Note**

Overlapping input and output reference address ranges in multi-word functions may produce unexpected results.

The following bit operation functions are described in this paragraph:

Abbreviation	Function	Description	Page
AND	Logical AND	If a bit in bit string I1 and the corresponding bit in bit string I2 are both 1, place a 1 in the corresponding location in output string Q.	4–41
OR	Logical OR	If a bit in bit string I1 and/or the corresponding bit in bit string I2 are both 1, place a 1 in the corresponding location in output string Q.	4–41
XOR	Logical exclusive OR	If a bit in bit string I1 and the corresponding bit in string I2 are different, place a 1 in the corresponding location in the output bit string.	4–44
NOT	Logical invert	Set the state of each bit in output bit string Q to the opposite state of the corresponding bit in bit string I1..	4–46
SHL	Shift Left	Shift all the bits in a word or string of words to the left by a specified number of places.	4–47
SHR	Shift Right	Shift all the bits in a word or string of words to the right by a specified number of places.	4–47
ROL	Rotate Left	Rotate all the bits in a string a specified number of places to the left.	4–49
ROR	Rotate Right	Rotate all the bits in a string a specified number of places to the right.	4–49
BTST	Bit Test	Test a bit within a bit string to determine whether that bit is currently 1 or 0.	4–51
BSET	Bit Set	Set a bit in a bit string to 1.	4–52
BCLR	Bit Clear	Clear a bit within a string by setting that bit to 0.	4–52
BPOS	Bit Position	Locate a bit set to 1 in a bit string.	4–54
MSKCOMP	Masked Compare	Compare the contents of two separate bit strings with the ability to mask selected bits (available for Release 4.5 or higher CPUs).	4–56

## 5.1. AND and OR (WORD)

Each scan that power is received, the AND or OR function examines each bit in bit string I1 and the corresponding bit in bit string I2, beginning at the least significant bit in each.

For each two bits examined for the AND function, if both are 1, then a 1 is placed in the corresponding location in output string Q. If either or both bits are 0, then a 0 is placed in string Q in that location.

The AND function is useful for building masks or screens, where only certain bits are passed through (those that are opposite a 1 in the mask), and all other bits are set to 0. The function can also be used to clear the selected area of word memory by ANDing the bits with another bit string known to contain all 0s. The I1 and I2 bit strings specified may overlap.

For each two bits examined for the OR function, if either or both bits are 1, then a 1 is placed in the corresponding location in output string Q. If both bits are 0, then a 0 is placed in string Q in that location.

The OR function is useful for combining strings, and to control many outputs through the use of one simple logical structure. The function is the equivalent of two relay contacts in parallel multiplied by the number of bits in the string. It can be used to drive indicator lamps directly from input states or superimpose blinking conditions on status lights.

The function passes power flow to the right whenever power is received.

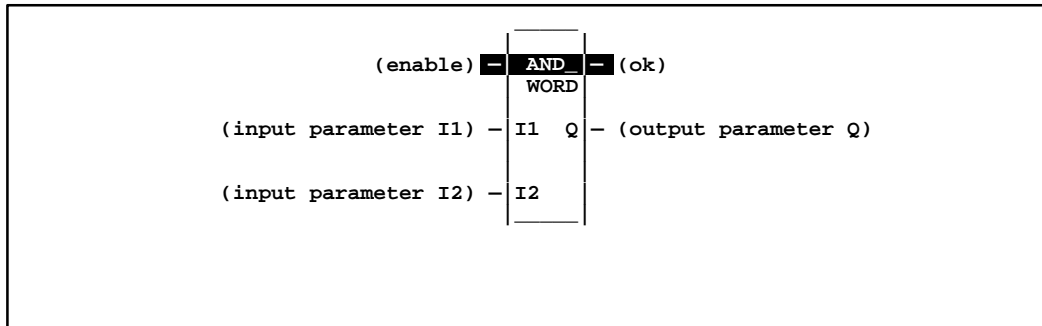

### 5.1.1. Parameters

Parameter	Description
enable	When the function is enabled, the operation is performed.
I1	I1 contains a constant or reference for the first word of the first string.
I2	I2 contains a constant or reference for the first word of the second string.
ok	The ok output is energized whenever enable is energized.
Q	Output Q contains the result of the operation.

### 5.1.2. Valid Memory Types

Parameter	flow	%I	%Q	%M	%T	%S	%G	%R	%AI	%AQ	const	none
enable	•											
I1		•	•	•	•	•	•	•	•	•	•	
I2		•	•	•	•	•	•	•	•	•	•	
ok	•											•
Q		•	•	•	•	•†	•	•	•	•		

- = Valid reference or place where power may flow through the function.
- † = %SA, %SB, or %SC only; %S cannot be used.

**Example:**

In the following example, whenever input %I0001 is set, the 16-bit strings represented by nicknames WORD1 and WORD2 are examined. The results of the Logical AND are placed in output string RESULT.



WORD1	0	0	0	1	1	1	1	1	1	1	0	0	1	0	0	0
WORD2	1	1	0	1	1	1	0	0	0	0	0	0	1	1	1	1
RESULT	0	0	0	1	1	1	0	0	0	0	0	0	1	0	0	0

## 5.2. XOR (WORD)

The Exclusive OR (XOR) function is used to compare each bit in bit string I1 with the corresponding bit in string I2. If the bits are different, a 1 is placed in the corresponding position in the output bit string.

Each scan that power is received, the function examines each bit in string I1 and the corresponding bit in string I2, beginning at the least significant bit in each. For each two bits examined, if only one is 1, then a 1 is placed in the corresponding location in bit string Q. The XOR function passes power flow to the right whenever power is received.

If string I2 and output string Q begin at the same reference, a 1 placed in string I1 will cause the corresponding bit in string I2 to alternate between 0 and 1, changing state with each scan as long as power is received. Longer cycles can be programmed by pulsing the power flow to the function at twice the desired rate of flashing; the power flow pulse should be one scan long (one-shot type coil or self-resetting timer).

The XOR function is useful for quickly comparing two bit strings, or to blink a group of bits at the rate of one ON state per two scans.

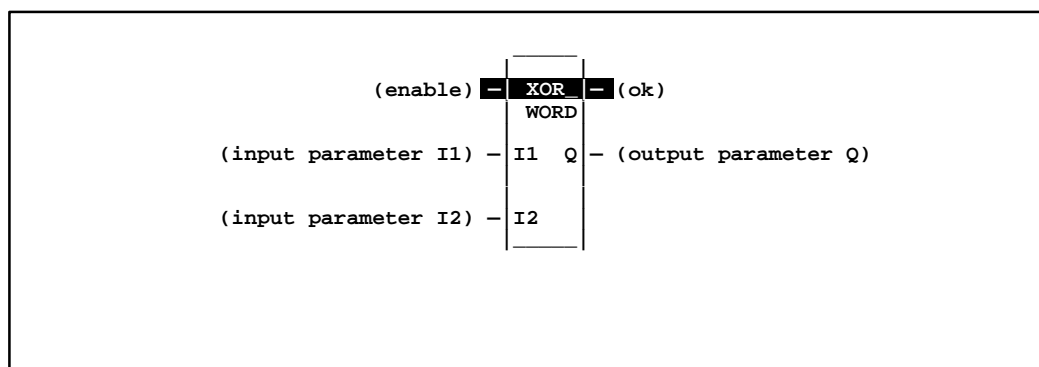

### 5.2.1. Parameters

Parameter	Description
enable	When the function is enabled, the operation is performed.
I1	I1 contains a constant or reference for the first word to be XORed.
I2	I2 contains a constant or reference for the second word to be XORed.
ok	The ok output is energized whenever enable is energized.
Q	Output Q contains the result of I1 XORed with I2.

### 5.2.2. Valid Memory Types

Parameter	flow	%I	%Q	%M	%T	%S	%G	%R	%AI	%AQ	const	none
enable	•											
I1		•	•	•	•	•	•	•	•	•	•	
I2		•	•	•	•	•	•	•	•	•	•	
ok	•											•
Q		•	•	•	•	•†	•	•	•	•		

- = Valid reference or place where power may flow through the function.
- † = %SA, %SB, or %SC only; %S cannot be used.

**Example:**

In the following example, whenever %I0001 is set, the bit string represented by the nickname WORD3 is cleared (set to all zeros).



I1 (WORD3)	0	0	0	1	1	1	1	1	1	1	0	0	1	0	0	0
I2 (WORD3)	0	0	0	1	1	1	1	1	1	1	0	0	1	0	0	0
Q (WORD3)	0	0	0	0	0	0	0	0	0	0	0	0	0	0	0	0

### 5.3. NOT (WORD)

The NOT function is used to set the state of each bit in the output bit string Q to the opposite of the state of the corresponding bit in bit string I1.

All bits are altered on each scan that power is received, making output string Q the logical complement of I1. The function passes power flow to the right whenever power is received.

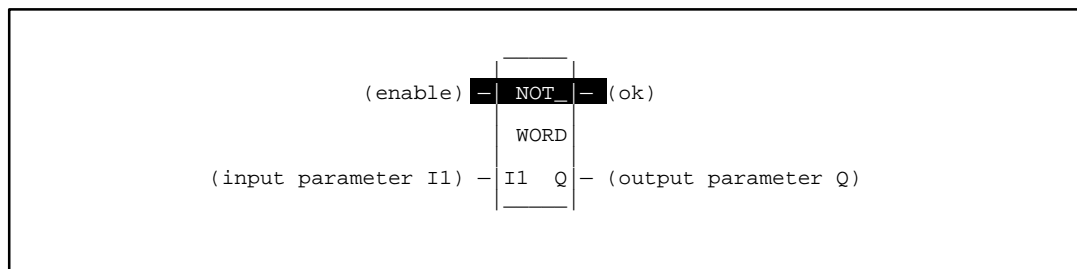

#### 5.3.1. Parameters

Parameter	Description
enable	When the function is enabled, the operation is performed.
I1	I1 contains the constant or reference for the word to be negated.
ok	The ok output is energized whenever enable is energized.
Q	Output Q contains the NOT (negation) of I1.

#### 5.3.2. Valid Memory Types

Parameter	flow	%I	%Q	%M	%T	%S	%G	%R	%AI	%AQ	const	none
enable	•											
I1		•	•	•	•	•	•	•	•	•	•	
ok	•											•
Q		•	•	•	•	•†	•	•	•	•		

• = Valid reference or place where power may flow through the function.

† = %SA, %SB, or %SC only; %S cannot be used.

#### Example:

In the following example, whenever input %I0001 is set, the bit string represented by the nickname TAC is set to the inverse of bit string CAT.



### 5.4. SHL and SHR (WORD)

The Shift Left (SHL) function is used to shift all the bits in a word or group of words to the left by a specified number of places. When the shift occurs, the specified number of bits is shifted out of the output string to the left. As bits are shifted out of the high end of the string, the same number of bits is shifted in at the low end.

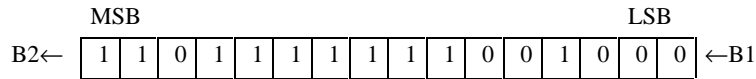

The Shift Right (SHR) function is used to shift all the bits in a word or group of words a specified number of places to the right. When the shift occurs, the specified number of bits is shifted out of the output string to the right. As bits are shifted out of the low end of the string, the same number of bits is shifted in at the high end.

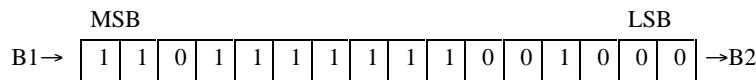

A string length of 1 to 256 words can be selected for either function.

If the number of bits to be shifted (N) is greater than the number of bits in the array (LEN) \* 16 or if the number of bits to be shifted is zero, then the array (Q) is filled with copies of the input bit (B1) and the input bit is copied to the output power flow (B2). If the number of bits to be shifted is zero, then no shifting is performed the input array is copied into the output array and input bit (B1) is copied into the power flow.

The bits being shifted into the beginning of the string are specified via input parameter B1. If a length greater than 1 has been specified as the number of bits to be shifted, each of the bits is filled with the same value (0 or 1). This can be:

- The boolean output of another program function.
- All 1s. To do this, use the special reference nickname ALW\_ON as a permissive to input B1.
- All 0s. To do this, use the special reference nickname ALW\_OFF as a permissive to input B1.

The SHL or SHR function passes power flow to the right, unless the number of bits specified to be shifted.

Output Q is the shifted copy of the input string. If you want the input string to be shifted, the output parameter Q must use the same memory location as the input parameter IN. The entire shifted string is written on each scan that power is received. Output B2 is the last bit shifted out. For example, if four bits were shifted, B2 would be the fourth bit shifted out.

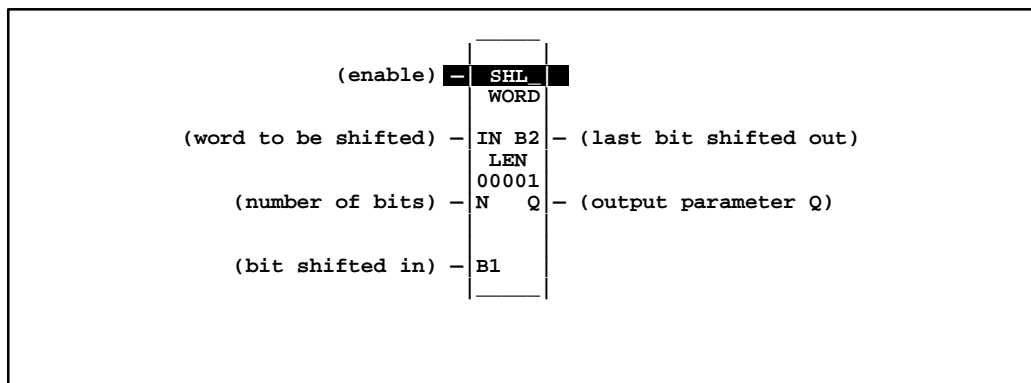

### 5.4.1. Parameters

Parameter	Description
enable	When the function is enabled, the shift is performed.
IN	IN contains the first word to be shifted.
N	N contains the number of places (bits) that the array is to be shifted.
B1	B1 contains the bit value to be shifted into the array.
B2	B2 contains the bit value of the last bit shifted out of the array.
Q	Output Q contains the first word of the shifted array.
LEN	LEN is the number of words in the array to be shifted.

### 5.4.2. Valid Memory Types

Parameter	flow	%I	%Q	%M	%T	%S	%G	%R	%AI	%AQ	const	none
enable	•											
IN		•	•	•	•	•	•	•	•	•		
N		•	•	•	•		•	•	•	•	•	
B1	•											
B2	•											•
Q		•	•	•	•	•†	•	•	•	•		

- = Valid reference or place where power may flow through the function.
- † = %SA, %SB, or %SC only; %S cannot be used.

#### Example:

In the following example, whenever input %I0001 is set, the output bit string represented by the nickname WORD2 is made a copy of WORD1, left-shifted by the number of bits represented by the nickname LENGTH. The resulting open bits at the beginning of the output string are set to the value of %I0002.

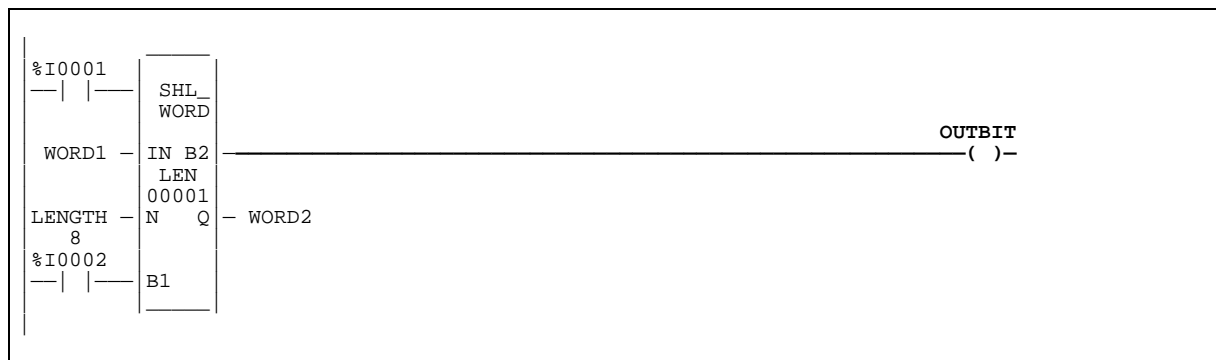

## 5.5. ROL and ROR (WORD)

The Rotate Left (ROL) function is used to rotate all the bits in a string a specified number of places to the left. When rotation occurs, the specified number of bits is rotated out of the input string to the left and back into the string on the right.

The Rotate Right (ROR) function rotates the bits in the string to the right. When rotation occurs, the specified number of bits is rotated out of the input string to the right and back into the string on the left.

A string length of 1 to 256 words can be selected for either function.

The number of places specified for rotation must be more than zero and less than the number of bits in the string. Otherwise, no movement occurs and no power flow is generated.

The ROL or ROR function passes power flow to the right, unless the number of bits specified to be rotated is greater than the total length of the string or is less than zero.

The result is placed in output string Q. If you want the input string to be rotated, the output parameter Q must use the same memory location as the input parameter IN. The entire rotated string is written on each scan that power is received.

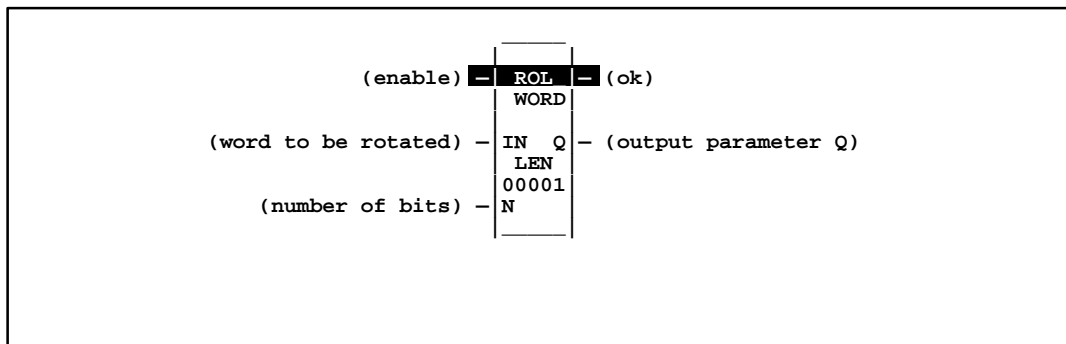

### 5.5.1. Parameters

Parameter	Description
enable	When the function is enabled, the rotation is performed.
IN	IN contains the first word to be rotated.
N	N contains the number of places that the array is to be rotated.
ok	The ok output is energized when the rotation is energized and the rotation length is not greater than the array size.
Q	Output Q contains the first word of the rotated array.
LEN	LEN is the number of words in the array to be rotated.

### 5.5.2. Valid Memory Types

Parameter	flow	%I	%Q	%M	%T	%S	%G	%R	%AI	%AQ	const	none
enable	•											
IN		•	•	•	•	•	•	•	•	•		
N		•	•	•	•		•	•	•	•	•	
ok	•											•
Q		•	•	•	•	•†	•	•	•	•		

• = Valid reference or place where power may flow through the function.

† = %SA, %SB, or %SC only; %S cannot be used.

#### Example:

In the following example, whenever input %I0001 is set, the input bit string %R0001 is rotated 3 bits and the result is placed in %R0002. After execution of this function, the input bit string %R0001 is unchanged. If the same reference is used for IN and Q, a rotation will occur in place.

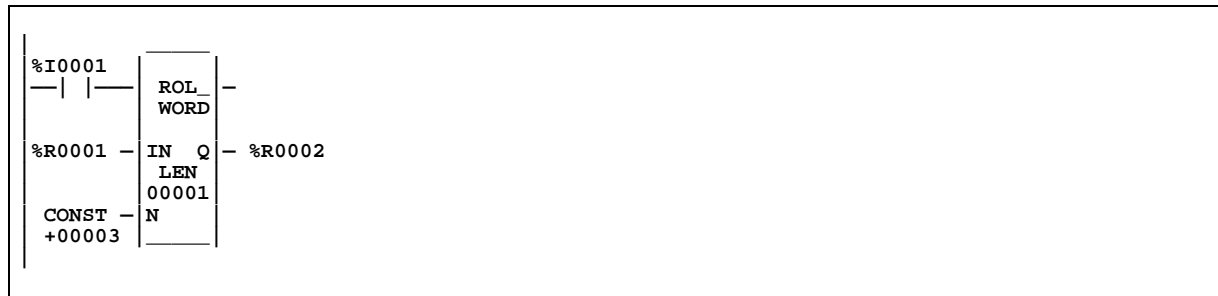

%R0001:

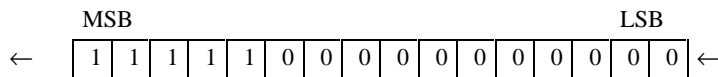

%R0002 (after %I0001 is set):

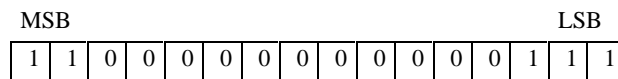

## 5.6. BTST (WORD)

The Bit Test (BTST) function is used to test a bit within a bit string to determine whether that bit is currently 1 or 0. The result of the test is placed in output Q.

Each sweep power is received, the BTST function sets its output Q to the same state as the specified bit. If a register rather than a constant is used to specify the bit number, the same function block can test different bits on successive sweeps. If the value of BIT is outside the range ( $1 \leq \text{BIT} \leq (16 * \text{LEN})$ ), then Q is set OFF.

A string length of 1 to 256 words can be selected.

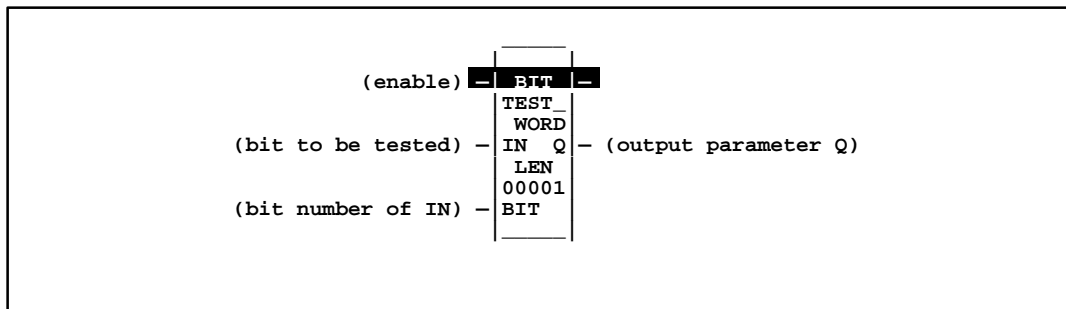

### 5.6.1. Parameters

Parameter	Description
enable	When the function is enabled, the bit test is performed.
IN	IN contains the first word of the data to be operated on.
BIT	BIT contains the bit number of IN that should be tested. Valid range is ( $1 \leq \text{BIT} \leq (16 * \text{LEN})$ ).
Q	Output Q is energized if the bit tested was a 1.
LEN	LEN is the number of words in the string to be tested.

### 5.6.2. Valid Memory Types

Parameter	flow	%I	%Q	%M	%T	%S	%G	%R	%AI	%AQ	const	none
enable	•											
IN		•	•	•	•	•	•	•	•	•		
BIT		•	•	•	•		•	•	•	•	•	
Q	•											•

• = Valid reference or place where power may flow through the function.

**Example:**

In the following example, whenever input %I0001 is set, the bit at the location contained in reference PICKBIT is tested. The bit is part of string PRD\_CDE. If it is 1, output Q passes power flow and the coil %Q0001 is turned on.



### 5.7. BSET and BCLR (WORD)

The Bit Set (BSET) function is used to set a bit in a bit string to 1. The Bit Clear (BCLR) function is used to clear a bit within a string by setting that bit to 0.

Each sweep that power is received, the function sets the specified bit to 1 for the BSET function or to 0 for the BCLR function. If a variable (register) rather than a constant is used to specify the bit number, the same function block can set different bits on successive sweeps.

A string length of 1 to 256 words can be selected. The function passes power flow to the right, unless the value for BIT is outside the range  $(1 \leq \text{BIT} \leq (16 * \text{LEN}))$ . Then, ok is set OFF.

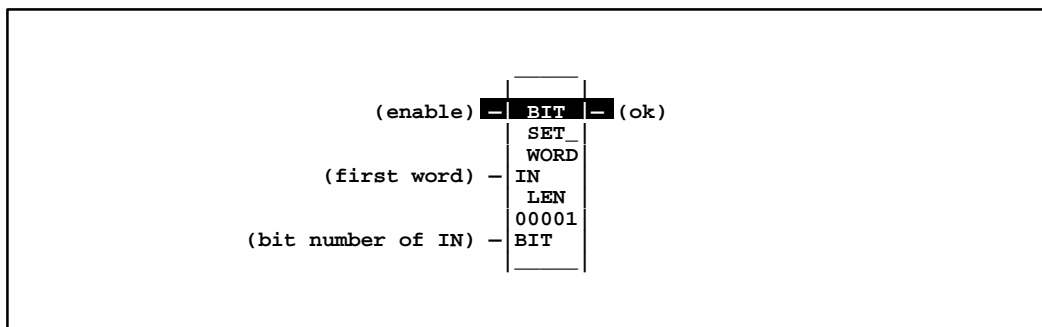

### 5.7.1. Parameters

Parameter	Description
enable	When the function is enabled, the bit operation is performed.
IN	IN contains the first word of the data to be operated on.
BIT	BIT contains the bit number of IN that should be set or cleared. Valid range is $(1 \leq \text{BIT} \leq (16 * \text{LEN}))$ .
ok	The ok output is energized whenever enable is energized.
LEN	LEN is the number of words in the bit string.

### 5.7.2. Valid Memory Types

Parameter	flow	%I	%Q	%M	%T	%S	%G	%R	%AI	%AQ	const	none
enable	•											
IN		•	•	•	•	†	•	•	•	•		
BIT		•	•	•	•		•	•	•	•	•	
ok	•											•

- = Valid reference or place where power may flow through the function.
- † = %SA, %SB, or %SC only; %S cannot be used.

#### Example:

In the following example, whenever input %I0001 is set, bit 12 of the string beginning at reference %R0040 is set to 1.

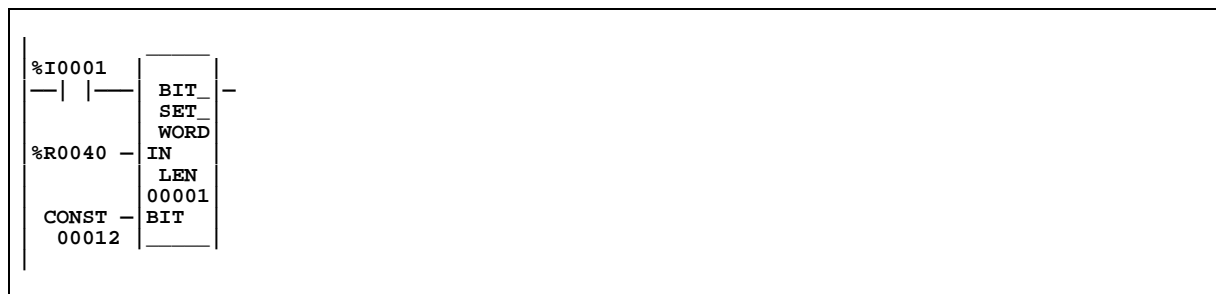

## 5.8. BPOS (WORD)

The Bit Position (BPOS) function is used to locate a bit set to 1 in a bit string.

Each sweep that power is received, the function scans the bit string starting at IN. When the function stops scanning, either a bit equal to 1 has been found or the entire length of the string has been scanned.

POS is set to the position within the bit string of the first non-zero bit; POS is set to zero if no non-zero bit is found.

A string length of 1 to 256 words can be selected. The function passes power flow to the right whenever enable is ON.

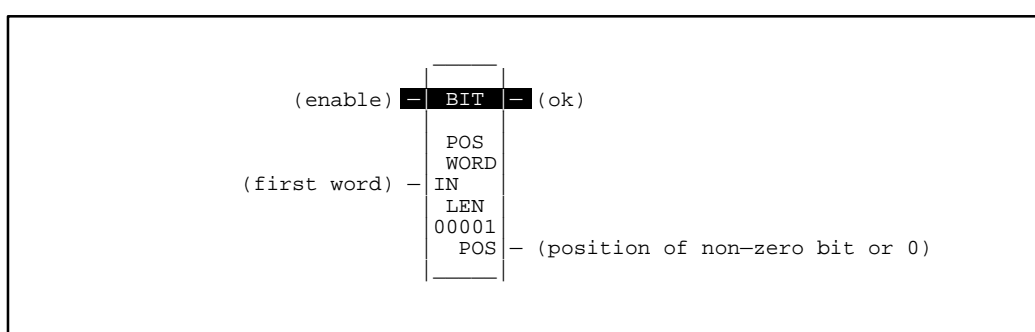

### 5.8.1. Parameters

Parameter	Description
enable	When the function is enabled, a bit search operation is performed.
IN	IN contains the first word of the data to be operated on.
ok	The ok output is energized whenever enable is energized.
POS	The position of the first non-zero bit found, or zero if a non-zero bit is not found.
LEN	LEN is the number of words in the bit string.

### 5.8.2. Valid Memory Types

Parameter	flow	%I	%Q	%M	%T	%S	%G	%R	%AI	%AQ	const	none
enable	•											
IN		•	•	•	•	•	•	•	•	•		
POS		•	•	•	•		•	•	•	•		
ok	•											•

• = Valid reference or place where power may flow through the function.

**Example:**

In the following example, if %I0001 is set, the bit string starting at %M0001 is searched until a bit equal to 1 is found, or 6 words have been searched. Coil %Q0001 is turned on. If a bit equal to 1 is found, its location within the bit string is written to %AQ001. If %I0001 is set, bit %M0001 is 0, and bit %M0002 is 1, then the value written to %AQ001 is 2.

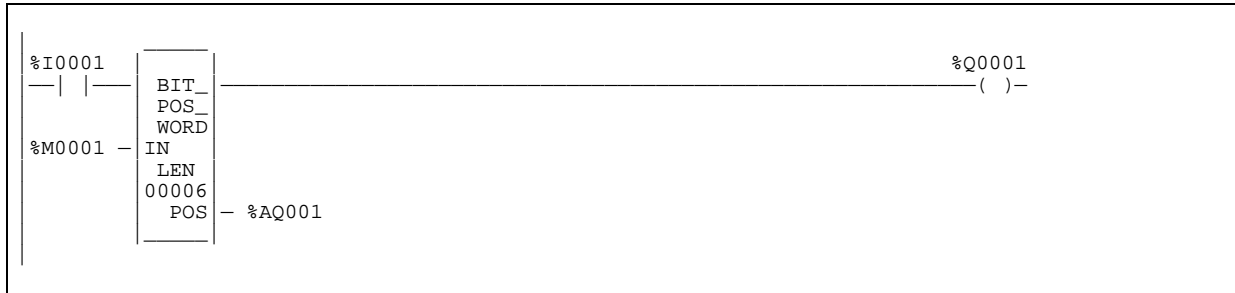

## 5.9. MSKCMP (WORD, DWORD)

The Masked Compare (MSKCMP) function (available for Release 4.41 or later CPUs) is used to compare the contents of two separate bit strings with the ability to mask selected bits. The length of the bit strings to be compared is specified by the LEN parameter (where the value of LEN specifies the number of 16-bit words for the MSKCMPW function and 32-bit words for the MSKCMPD function).

When the logic controlling the enable input to the function passes power flow to the enable (EN) input, the function begins comparing the bits in the first string with the corresponding bits in the second string. Comparison continues until a miscompare is found, or until the end of the string is reached.

The BIT input is used to store the bit number where the next comparison should start (where a "0" indicates the first bit in the string). The BN output is used to store the bit number where the last comparison occurred (where a "1" indicates the first bit in the string). Using the same reference for BIT and BN causes the compare to start at the next bit position after a miscompare; or, if all bits compared successfully upon the next invocation of the function block, the compare starts at the beginning.

If you want to start the next comparison at some other location in the string, you can enter different references for BIT and BN. If the value of BIT is a location that is beyond the end of the string, BIT is reset to 0 before starting the next comparison.

### If All Bits in I1 and I2 are the Same

If all corresponding bits in strings I1 and I2 match, the function sets the "miscompare" output MC to 0 and BN to the highest bit number in the input strings. The comparison then stops. On the next invocation of MSKCMPW, it will be reset to 0.

### If a Miscompare is Found

When the two bits currently being compared are not the same, the function checks the correspondingly numbered bit in string M (the mask). If the mask bit is a "1", the comparison continues until it reaches another miscompare or the end of the input strings.

If a miscompare is detected and the corresponding mask bit is a "0", the function does the following:

1. Sets the corresponding mask bit in M to 1.
2. Sets the miscompare (MC) output to 1.
3. Updates the output bit string Q to match the new content of mask string M
4. Sets the bit number output (BN) to the number of the miscompared bit.
5. Stops the comparison.

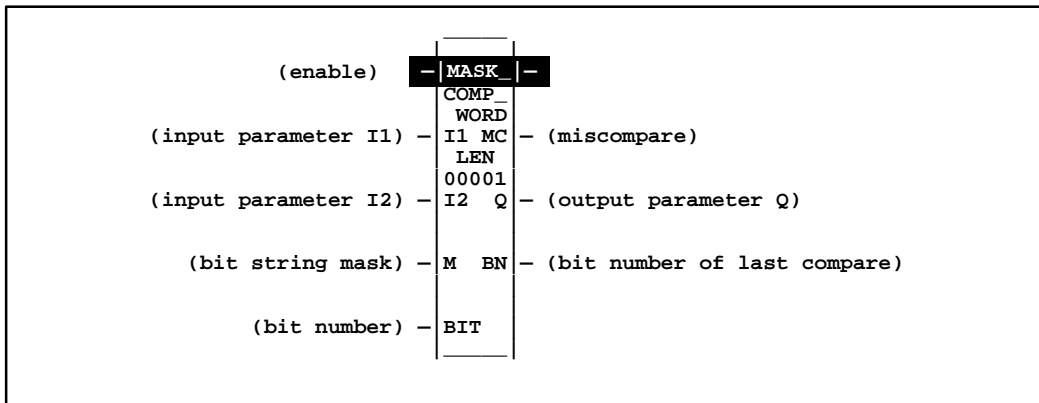

### 5.9.1. Parameters

Parameter	Description
enable	Permissive logic to enable the function.
I1	Reference for the first bit string to be compared.
I2	Reference for the second bit string to be compared.
M	Reference for the bit string mask.
BIT	Reference for the bit number where the next comparison should start.
MC	User logic to determine if a miscompare has occurred.
Q	Output copy of the mask (M) bit string.
BN	Number of the bit where the last compare occurred.
LEN	LEN is the number of words in the bit string.

### 5.9.2. Valid Memory Types

Parameter	flow	%I	%Q	%M	%T	%S	%G	%R	%AI	%AQ	const	none
enable	•											
I1		o	o	o	o	o	o	•	•	•		
I2		o	o	o	o	o	o	•	•	•		
M		o	o	o	o	o†	o	•	•	•		
BIT		•	•	•	•	•	•	•	•	•	•	
LEN											•‡	
MC	•											•
Q		o	o	o	o	o†	o	•	•	•		
BN		•	•	•	•	•	•	•	•	•		

- Valid reference or place where power may flow through the function.
- o Valid reference for WORD data only; not valid for DWORD.
- † %SA, %SB, %SC only; %S cannot be used.
- ‡ Max const value of 4095 for WORD and 2047 for DWORD.

**Example:**

In the following example, after first scan, the MSKCOMPW function block is executed. %M0001 through %M0016 is compared with %M0017 through %M0032. %M0033 through %M0048 contains the mask value. The value in %R0001 determines at which bit position the comparison starts within the two input strings. The contents of the above references before the function block is executed are as follows:

(I1) – %M0001 = 6C6Ch =

0	1	1	0	1	1	0	0	0	1	1	0	1	1	0	0
---	---	---	---	---	---	---	---	---	---	---	---	---	---	---	---

(I2) – %M0017 = 606Fh =

0	1	1	0	1	1	0	1	0	1	1	0	1	1	1	1
---	---	---	---	---	---	---	---	---	---	---	---	---	---	---	---

(M/Q) – %M0033 = 000Fh =

0	0	0	0	0	0	0	0	0	0	0	0	1	1	1	1
---	---	---	---	---	---	---	---	---	---	---	---	---	---	---	---

(BIT/BN) – %R0001 = 0

(MC) – %Q0001 = OFF

The contents of these references after the function block is executed are as follows:

(I1) – %M0001 =

0	1	1	0	1	1	0	0	0	1	1	0	1	1	0	0
---	---	---	---	---	---	---	---	---	---	---	---	---	---	---	---

(I2) – %M0017 =

0	1	1	0	1	1	0	1	0	1	1	0	1	1	1	1
---	---	---	---	---	---	---	---	---	---	---	---	---	---	---	---

(M/Q) – %M0033

0	0	0	0	0	0	0	1	0	0	0	0	1	1	1	1
---	---	---	---	---	---	---	---	---	---	---	---	---	---	---	---

(BIT/BN) – %R0001 = 8

(MC) – %Q0001 = ON

**Ladder Diagram Representation**



Notice that, in the example shown above, we used the contact %T1 and the coil %M100 to force one and only one execution; otherwise the masked compare would repeat, not necessarily delivering the desired results.

## 6. DATA MOVE FUNCTIONS

Data move functions provide basic data move capabilities. This paragraph describes the following data move functions:

Abbreviation	Function	Description	Page
MOVE	Move	Copy data as individual bits. The maximum length allowed is 256 words, except MOVE_BIT is 256 bits. Data can be moved into a different data type without prior conversion.	4–60
BLKMOV	Block Move	Copy a block of seven constants to a specified memory location. The constants are input as part of the function.	4–63
BLKCLR	Block Clear	Replace the content of a block of data with all zeros. This function can be used to clear an area of bit (%I, %Q, %M, %G, or %T) or word (%R, %AI, or %AQ) memory. The maximum length allowed is 256 words.	4–65
SHFR	Shift Register	Shift one or more data words into a table. The maximum length allowed is 256 words.	4–66
BITSEQ	Bit Sequencer	Perform a bit sequence shift through an array of bits. The maximum length allowed is 256 words.	4–69
COMMREQ	Communications Request	Allow the program to communicate with an intelligent module, such as an N80 Communications Module or a Programmable Coprocessor Module.	4–72

### 6.1. MOVE (BIT, INT, WORD)

Use the MOVE function to copy data (as individual bits) from one location to another. Because the data is copied in bit format, the new location does not need to be the same data type as the original location.

The MOVE function has two input parameters and two output parameters. When the function receives power flow, it copies data from input parameter IN to output parameter Q as bits. If data is moved from one location in discrete memory to another, (for example, from %I memory to %T memory), the transition information associated with the discrete memory elements is updated to indicate whether or not the MOVE operation caused any discrete memory elements to change state. Data at the input parameter does not change unless there is an overlap in the source destination.

For the BIT type there is another consideration. If a BIT array specified on the Q parameter does not encompass all of the bits in a byte, the transition bits associated with that byte (which are not in the array) will be cleared when the MOVE\_BIT receives power flow.

Input IN can be either a reference for the data to be moved or a constant. If a constant is specified, then the constant value is placed in the location specified by the output reference. For example, if a constant value of 4 is specified for IN, then 4 is placed in the memory location specified by Q. If the length is greater than 1 and a constant is specified, then the constant is placed in the memory location specified by Q and the locations following, up to the length specified. For example, if the constant value 9 is specified for IN and the length is 4, then 9 is placed in the memory location specified by Q and the three locations following.

The LEN operand specifies the number of:

- Words to be moved for MOVE\_INT and MOVE\_WORD.
- Bits to be moved for MOVE\_BIT.
- Reals to be moved for MOVE\_REAL.

**Note**

The REAL data type is only available on 352 CPUs.

The function passes power to the right whenever power is received.

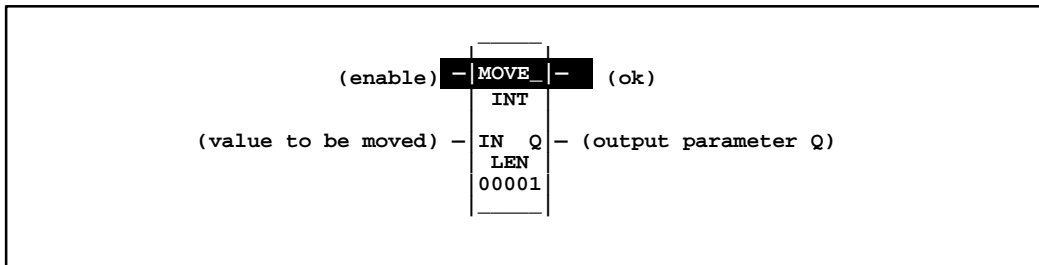

### 6.1.1. Parameters

Parameter	Description
enable	When the function is enabled, the move is performed.
IN	IN contains the value to be moved. For MOVE_BIT, any discrete reference may be used; it does not need to be byte aligned. However, 16 bits, beginning with the reference address specified, are displayed online.
ok	The ok output is energized whenever the function is enabled.
Q	When the move is performed, the value at IN is written to Q. For MOVE_BIT, any discrete reference may be used; it does not need to be byte aligned. However, 16 bits, beginning with the reference address specified, are displayed online.
LEN	LEN specifies the number of words or bits to be moved. For MOVE_WORD and MOVE_INT, LEN must be between 1 and 256 words. For MOVE_BIT, when IN is a constant, LEN must be between 1 and 16 bits; otherwise, LEN must be between 1 and 256.

**Note**

On 351 and 352 CPUs, the MOVE\_INT and MOVE\_WORD functions do not work properly if you allow overlapping of IN and Q parameters.

Also, please note that the 352 CPU is the only C80–35 Floating Point CPU at this time and therefore the only one capable of MOVE\_REAL.

### 6.1.2. Valid Memory Types

Parameter	flow	%I	%Q	%M	%T	%S	%G	%R	%AI	%AQ	const	none
enable	•											
IN		•	•	•	•	o	•	•	•	•	•	
ok	•											•
Q		•	•	•	•	o†	•	•	•	•		

**Note:** For REAL data, the only valid types are %R, %AI and %AQ.

- = Valid reference for BIT, INT, or WORD data, or place where power may flow through the function.  
For MOVE\_BIT, discrete user references %I, %Q, %M and %T need not be byte aligned.
- o = Valid reference for BIT or WORD data only; not valid for INT.
- † = %SA, %SB, %SC only; %S cannot be used.

#### Example 1

When enabling input %Q0014 is ON, 48 bits are moved from memory location %M0001 to memory location %M0033. Even though the destination overlaps the source for 16 bits, the move is done correctly (except for the 351 and 352 CPUs as noted on previously).

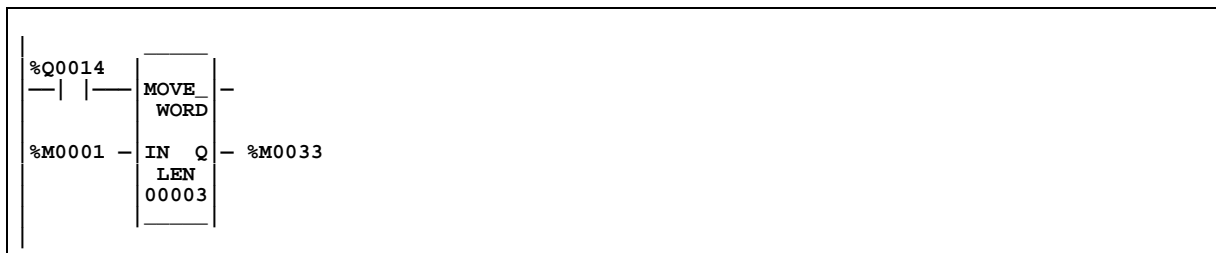

#### Before using the Move function:

INPUT (%M0001 to %M0048)

	1															
%M0016	1	1	1	1	0	0	0	0	1	1	1	1	0	0	0	0
%M0032	0	0	0	0	1	1	1	1	0	0	0	0	1	1	1	1
%M0048	1	1	1	1	1	1	1	1	1	1	1	1	1	1	1	1

#### After using the Move function:

INPUT (%M0033 to %M0080)

	33															
%M0048	1	1	1	1	0	0	0	0	1	1	1	1	0	0	0	0
%M0064	0	0	0	0	1	1	1	1	0	0	0	0	1	1	1	1
%M0080	1	1	1	1	1	1	1	1	1	1	1	1	1	1	1	1

#### Example 2

In this example, whenever %I0001 is set, the three bits %M0001, %M0002 and %M0003 are moved to %M0100, %M0101 and %M0102, respectively. Coil %Q0001 is turned on.

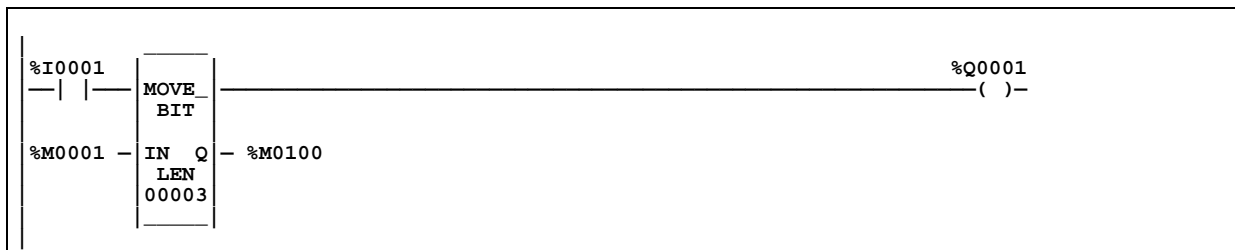

## 6.2. BLKMOV (INT, WORD, REAL)

Use the Block Move (BLKMOV) function to copy a block of seven constants to a specified location.

The BLKMOV function has eight input parameters and two output parameters. When the function receives power flow, it copies the constant values into consecutive locations, beginning at the destination specified in output Q. Output Q cannot be the input of another program function.

**Note**

The REAL data type is only available on 352 CPUs.

For BLKMOV\_INT, the values of IN1 — IN7 are displayed as signed decimals. For BLKMOV\_WORD, IN1 — IN7 are displayed in hexadecimal. For BLKMOV\_REAL, IN1–IN7 are displayed in Real format.

The function passes power to the right whenever power is received.

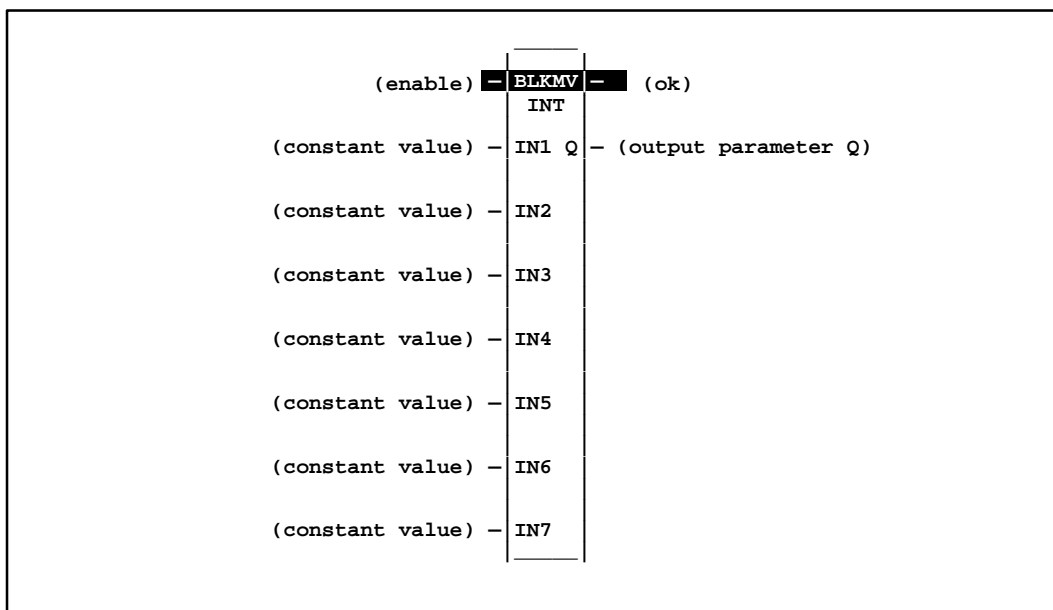

### 6.2.1. Parameters

Parameter	Description
enable	When the function is enabled, the block move is performed.
IN1—IN7	IN1 to IN7 contain seven constant values.
ok	The ok output is energized whenever the function is enabled.
Q	Output Q contains the first integer of the moved array. IN1 is moved to Q.

### 6.2.2. Valid Memory Types

Parameter	flow	%I	%Q	%M	%T	%S	%G	%R	%AI	%AQ	const	none
enable	•											
IN1 — IN7											•	
ok	•											•
Q		•	•	•	•	o†	•	•	•	•		

**Note:** For REAL data, the only valid types are %R, %AI and %AQ.

- = Valid reference for place where power may flow through the function.
- o = Valid reference for WORD data only; not valid for INT or REAL.
- † = %SA, %SB, %SC only; %S cannot be used.

**Note**

The 352 CPU is the only C80-35 Floating Point CPU at this time and therefore the only one capable of BLKMV\_REAL.

#### Example

In the following example, when the enabling input represented by the nickname FST\_SCN is ON, the BLKMOV function copies the seven input constants into memory locations %R0010 to %R0016.

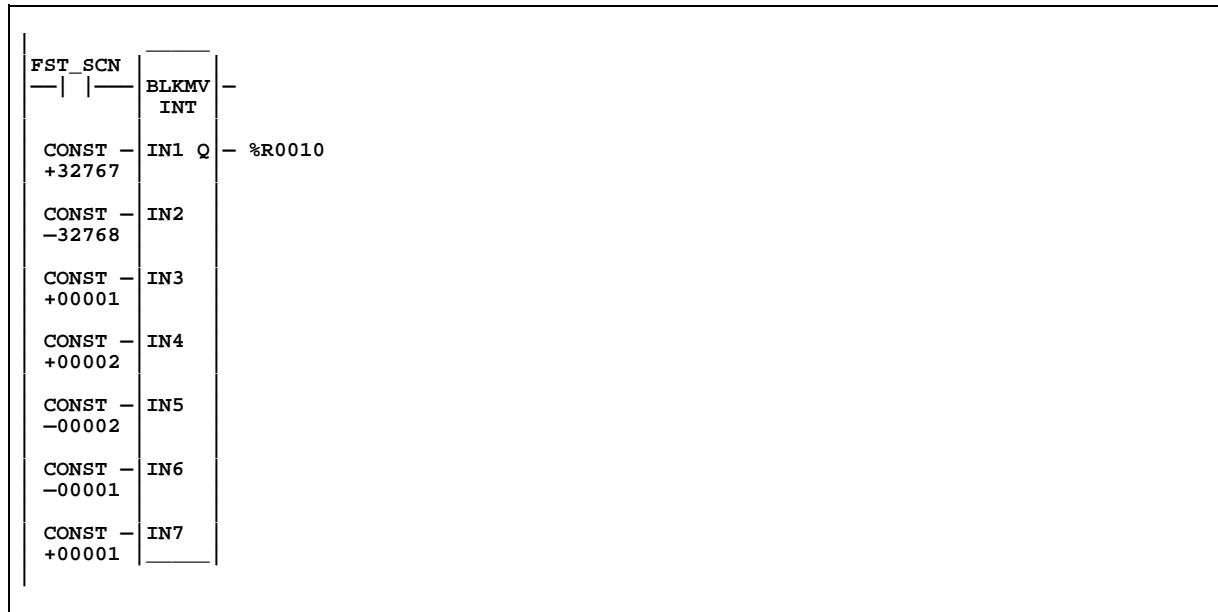

### 6.3. BLKCLR (WORD)

Use the Block Clear (BLKCLR) function to fill a specified block of data with zeros.

The BLKCLR function has two input parameters and one output parameter. When the function receives power flow, it writes zeros into the memory location beginning at the reference specified by IN. When the data to be cleared is from discrete memory (%I, %Q, %M, %G, or %T), the transition information associated with the references is also cleared.

The function passes power to the right whenever power is received.

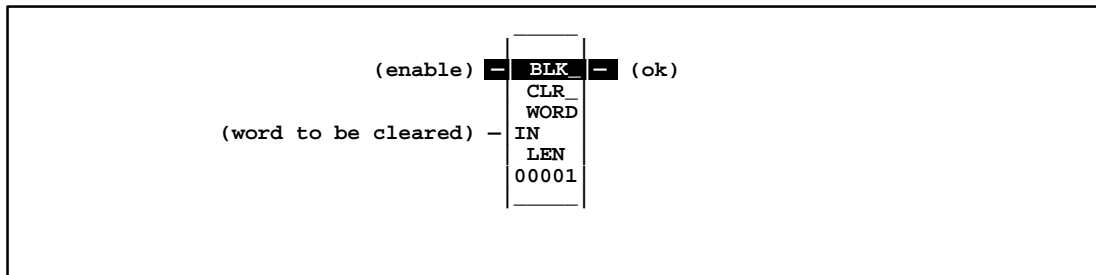

#### 6.3.1. Parameters

Parameter	Description
enable	When the function is enabled, the array is cleared.
IN	IN contains the first word of the array to be cleared.
ok	The ok output is energized whenever the function is enabled.
LEN	LEN must be between 1 and 256 words.

#### 6.3.2. Valid Memory Types

Parameter	flow	%I	%Q	%M	%T	%S	%G	%R	%AI	%AQ	const	none
enable	•											
IN		•	•	•	•	•†	•	•	•	•		
ok	•											•

- = Valid reference or place where power may flow through the function.
- † = %SA, %SB, %SC only; %S cannot be used.

#### Example

In the following example, at power-up, 32 words of %Q memory (512 points) beginning at %Q0001 are filled with zeros.

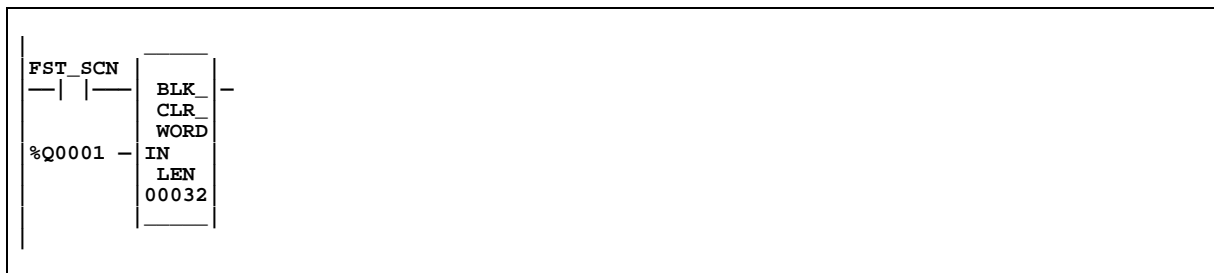

## 6.4. SHFR (BIT, WORD)

Use the Shift Register (SHFR) function to shift one or more data words or data bits from a reference location into a specified area of memory. For example, one word might be shifted into an area of memory with a specified length of five words. As a result of this shift, another word of data would be shifted out of the end of the memory area.

**Note**

When assigning reference addresses, overlapping input and output reference address ranges in multi-word functions may produce unexpected results.

The SHFR function has four input parameters and two output parameters. The reset input (R) takes precedence over the function enable input. When the reset is active, all references beginning at the shift register (ST) up to the length specified for LEN, are filled with zeros.

If the function receives power flow and reset is not active, each bit or word of the shift register is moved to the next highest reference. The last element in the shift register is shifted into Q. The highest reference of the shift register element of IN is shifted into the vacated element starting at ST. The contents of the shift register are accessible throughout the program because they are overlaid on absolute locations in logic addressable memory.

The function passes power to the right whenever power is received through the enable logic.

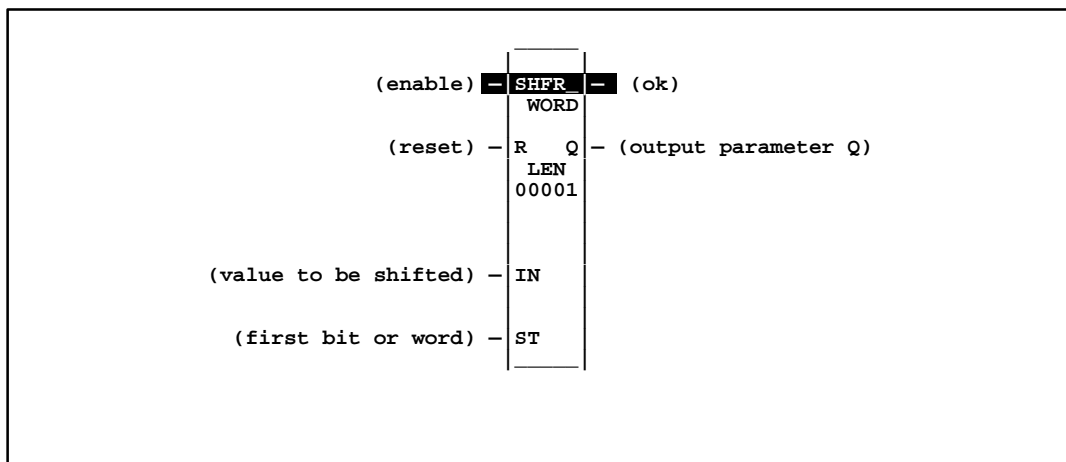

### 6.4.1. Parameters

Parameter	Description
enable	When enable is energized and R is not, the shift is performed.
R	When R is energized, the shift register located at ST is filled with zeros.
IN	IN contains the value to be shifted into the first bit or word of the shift register. For SHFR_BIT, any discrete reference may be used; it does not need to be byte aligned. However, 16 bits, beginning with the reference address specified, are displayed on–line.
ST	ST contains the first bit or word of the shift register. For SHFR_BIT, any discrete reference may be used; it does not need to be byte aligned. However, 16 bits, beginning with the reference address specified, are displayed on–line.
ok	The ok output is energized whenever the function is enabled and R is not enabled.
Q	Output Q contains the bit or word shifted out of the shift register. For SHFR_BIT, any discrete reference may be used; it does not need to be byte aligned. However, 16 bits, beginning with the reference address specified, are displayed on–line.
LEN	LEN determines the length of the shift register. For SHFR_WORD, LEN must be between 1 and 256 words. For SHFR_BIT, LEN must be between 1 and 256 bits.

### 6.4.2. Valid Memory Types

Parameter	flow	%I	%Q	%M	%T	%S	%G	%R	%AI	%AQ	const	none
enable	•											
R	•											
IN		•	•	•	•	•	•	•	•	•	•	
ST		•	•	•	•	•†	•	•	•	•		
ok	•											•
Q		•	•	•	•	•†	•	•	•	•		

- = Valid reference for BIT or WORD data, or place where power may flow through the function. For SHFR\_BIT, discrete user references %I, %Q, %M and %T need not be byte aligned.
- † = %SA, %SB, %SC only; %S cannot be used.

**Example 1**

In the following example, the shift register operates on register memory locations %R0001 to %R0100. When the reset reference CLEAR is active, the shift register words are set to zero.

When the NXT\_CYC reference is active and CLEAR is not active, the word from output status table location %Q0033 is shifted into the shift register at %R0001. The word shifted out of the shift register from %R0100 is stored in output %M0005.

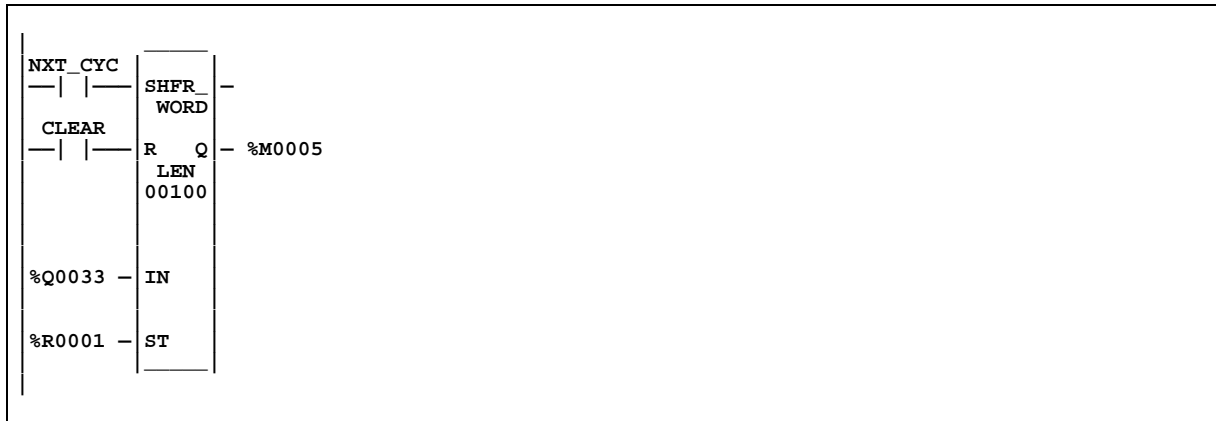

**Example 2**

In this example, the shift register operates on memory locations %M0001 to %M0100. When the reset reference CLEAR is active, the SHFR function fills %M0001 to %M0100 with zeros.

When NXT\_CYC is active and CLEAR is not, the SHFR function shifts the data in %M0001 to %M0100 down by one bit. The bit in %Q0033 is shifted into %M0001 while the bit shifted out of %M0100 is written to %M0200.

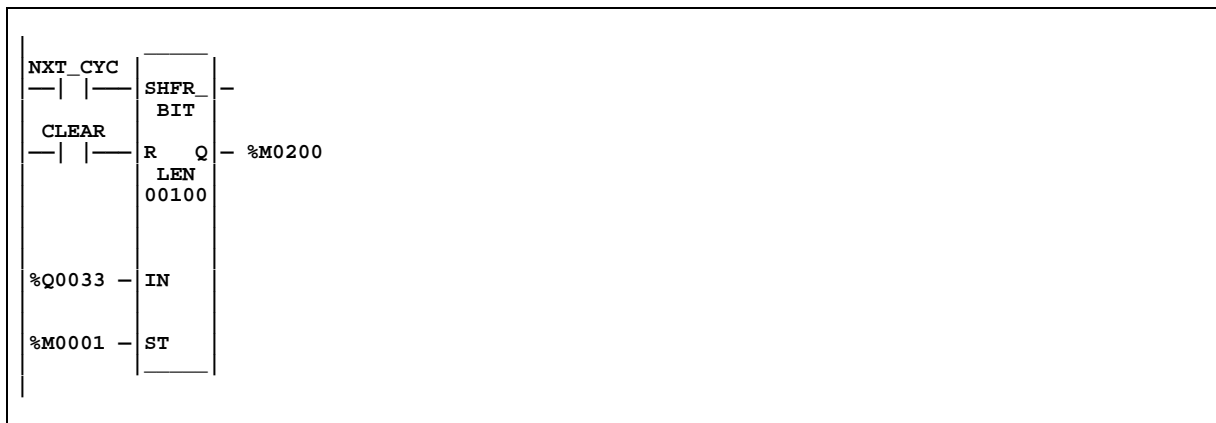

## 6.5. BITSEQ (BIT)

The Bit Sequencer (BITSEQ) function performs a bit sequence shift through an array of bits. The BITSEQ function has five input parameters and one output parameter. The operation of the function depends on the previous value of the parameter EN, as shown in the following table.

R Current Execution	EN Previous Execution	EN Current Execution	Bit Sequencer Execution
OFF	OFF	OFF	Bit sequencer does not execute.
OFF	OFF	ON	Bit sequencer increments/decrements by 1.
OFF	ON	OFF	Bit sequencer does not execute.
OFF	ON	ON	Bit sequencer does not execute.
ON	ON/OFF	ON/OFF	Bit sequencer resets.

The reset input (R) overrides the enable (EN) and always resets the sequencer. When R is active, the current step number is set to the value passed in via the step number parameter. If no step number is passed in, step is set to 1. All of the bits in the sequencer are set to 0, except for the bit pointed to by the current step, which is set to 1.

When EN is active and R is not active, the bit pointed to by the current step number is cleared. The current step number is either incremented or decremented, based on the direction parameter. Then, the bit pointed to by the new step number is set to 1.

- When the step number is being incremented and it goes outside the range of  $(1 \leq \text{step number} \leq \text{LEN})$ , it is set back to 1.
- When the step number is being decremented and it goes outside the range of  $(1 \leq \text{step number} \leq \text{LEN})$ , it is set to LEN.

The parameter ST is optional. If it is not used, the BITSEQ operates as described above, except that no bits are set or cleared. Basically, the BITSEQ then just cycles the current step number through its legal range.

### 6.5.1. Memory Required for a Bit Sequencer

Each bit sequencer uses three words (registers) of %R memory to store the following information:

current step number	word 1
length of sequence (in bits)	word 2
control word	word 3

When you enter a bit sequencer, you must enter a beginning address for these three words (registers) directly below the graphic representing the function (see example on next page).

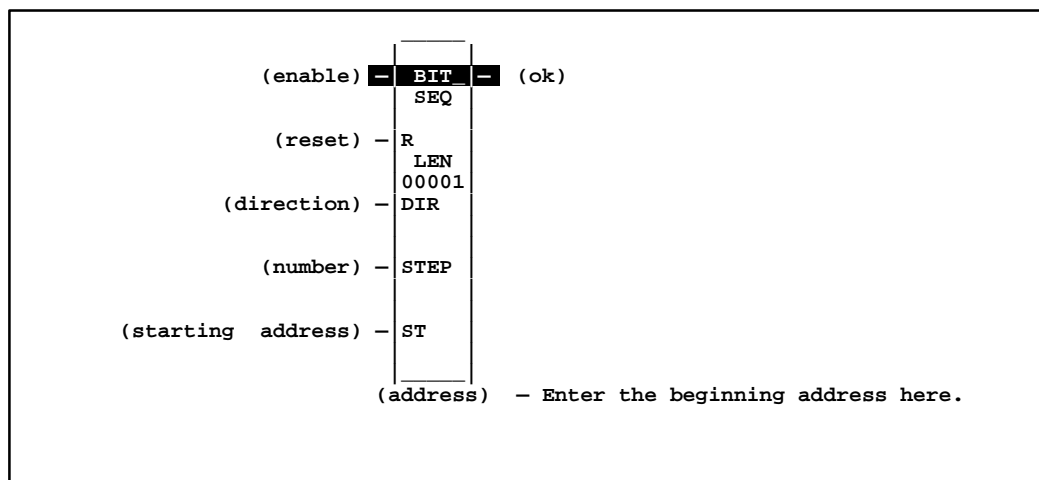

The control word stores the state of the boolean inputs and outputs of its associated function block, as shown in the following format:

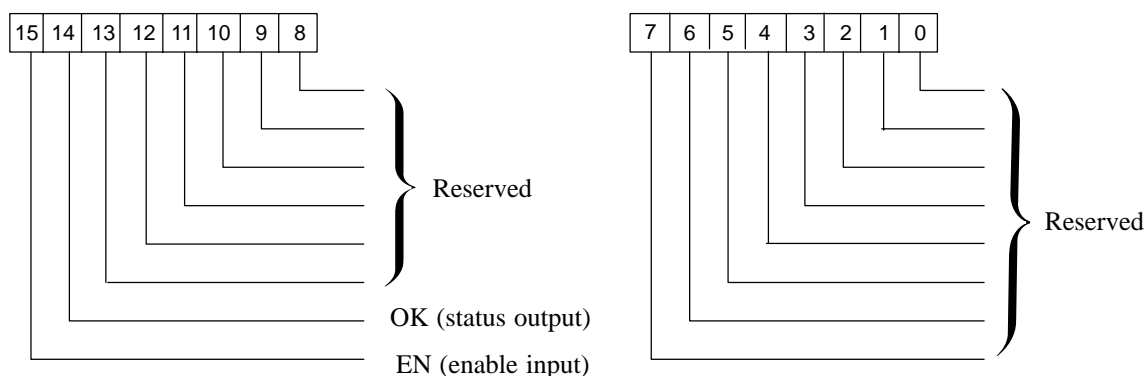

**Note**

Bits 0 to 13 are not used.

### 6.5.2. Parameters

Parameter	Description
address	Address is the location of the bit sequencer's current step, length and the last enable and ok statuses.
enable	When the function is enabled, if it was not enabled on the previous sweep and if R is not energized, the bit sequence shift is performed.
R	When R is energized, the bit sequencer's step number is set to the value in STEP (default = 1) and the bit sequencer is filled with zeros, except for the current step number bit.
DIR	When DIR is energized, the bit sequencer's step number is incremented prior to the shift. Otherwise, it is decremented.
STEP	When R is energized, the step number is set to this value.
ST	ST contains the first word of the bit sequencer.
ok	The ok output is energized whenever the function is enabled.
LEN	LEN must be between 1 and 256 bits.

Note

Coil checking, for the BITSEQ function, checks for 16 bits from the ST parameter, even when LEN is less than 16.

### 6.5.3. Valid Memory Types

Parameter	flow	%I	%Q	%M	%T	%S	%G	%R	%AI	%AQ	const	none
address								•				
enable	•											
R	•											
DIR	•											
STEP		•	•	•	•		•	•	•	•	•	•
ST		•	•	•	•	•†	•	•	•	•		•
ok	•											•

- = Valid reference or place where power may flow through the function.
- † = SA, %SB, %SC only; %S cannot be used

**Example:**

In the following example, the sequencer operates on register memory %R0001. Its static data is stored in registers %R0010, %R0011 and %R0012. When CLEAR is active, the sequencer is reset and the current step is set to step number 3. The first 8 bits of %R0001 are set to zero.

When NXT\_SEQ is active and CLEAR is not active, the bit for step number 3 is cleared and the bit for step number 2 or 4 (depending on whether DIR is energized) is set.



## 6.6. COMMREQ

Use the Communication Request (COMMREQ) function if the program needs to communicate with an intelligent module, such as an N80 Communications Module or a Programmable Coprocessor Module.

**Note**

The information presented on the following pages shows the format of the COMMREQ function. You will need additional information to program the COMMREQ for each type of device. Programming requirements for each module that uses the COMMREQ function are described in the module's documentation.

The COMMREQ function has three input parameters and one output parameter. When the COMMREQ function receives power flow, a command block of data is sent to the intelligent module. The command block begins at the reference specified using the parameter IN. The rack and slot number of the intelligent module is specified in SYSID.

The COMMREQ may either send a message and wait for a reply or send a message and continue without waiting for a reply. If the command block specifies that the program will not wait for a reply, the command block contents are sent to the receiving device and the program execution resumes immediately. (The timeout value is ignored.) This is referred to as **NOWAIT** mode.

If the command block specifies that the program will wait for a reply, the command block contents are sent to the receiving device and the CPU waits for a reply. The maximum length of time the PLC will wait for the device to respond is specified in the command block. If the device does not respond within that time, program execution resumes. This is referred to as **WAIT** mode.

The Function Faulted (FT) output may be set ON if:

1. The specified target address is not present (SYSID).
2. The specified task is not valid for the device (TASK).
3. The data length is 0.
4. The device's status pointer address (part of the command block) does not exist. This may be due to an incorrect memory type selection, or an address within that memory type that is out of range.

### 6.6.1. Command Block

The command block provides information to the intelligent module on the command to be performed.

The address of the command block is specified for the IN input to the COMMREQ function. This address may be in any word—oriented area of memory (%R, %AI or %AQ). The length of the command block depends on the amount of data sent to the device.

The command block has the following structure:

Length (in words)	address
Wait/No Wait Flag	address + 1
Status Pointer Memory	address + 2
Status Pointer Offset	address + 3
Idle Timeout Value	address + 4
Maximum Communication Time	address + 5
Data Block	address + 6
	to address + 133

Information required for the command block can be placed in the designated memory area using an appropriate programming function.

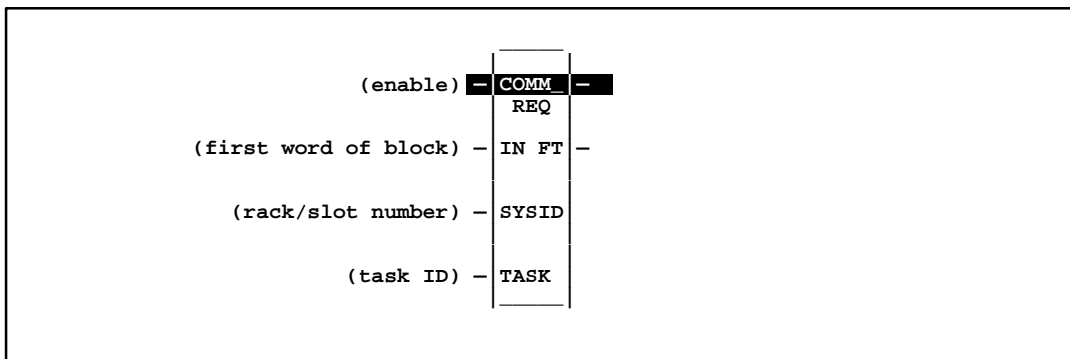

### 6.6.2. Parameters

Parameter	Description
enable	When the function is energized, the communications request is performed.
IN	IN contains the first word of the command block.
SYSID	SYSID contains the rack number (most significant byte) and slot number (least significant byte) of the target device.
TASK	TASK contains the task ID of the process on the target device.
FT	FT is energized if an error is detected processing the COMMREQ.

### 6.6.3. Valid Memory Types

Parameter	flow	%I	%Q	%M	%T	%S	%G	%R	%AI	%AQ	const	none
enable	•											
IN								•	•	•		
SYSID		•	•	•	•		•	•	•	•	•	
TASK								•	•	•	•	
FT	•											•

• = Valid reference or place where power may flow through the function.

#### Example

In the following example, when enabling input %M0020 is ON, a command block located starting at %R0016 is sent to communications task 1 in the device located at rack 1, slot 2 of the PLC. If an error occurs processing the COMMREQ, %Q0100 is set.

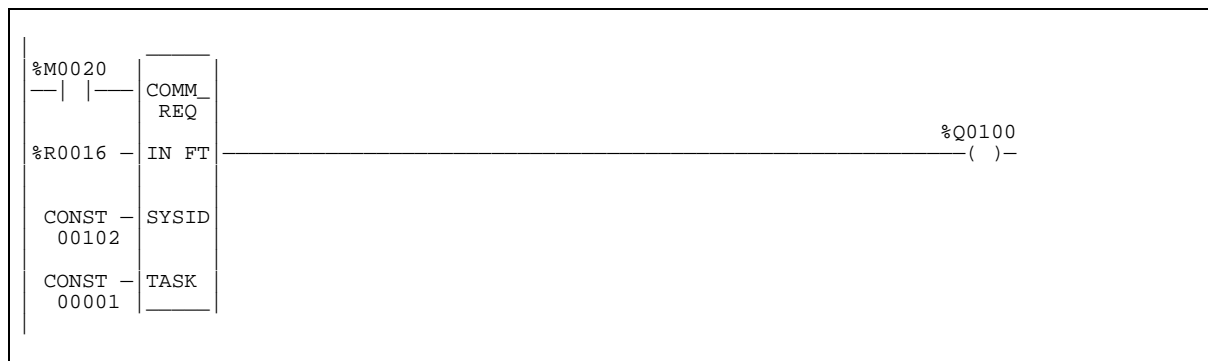

**Note**

For systems that do not have expansion racks, the SYSID must be zero for the main rack.

## 7. TABLE FUNCTIONS

Table functions are used to perform the following functions:

Abbreviation	Function	Description	Page
ARRAY_MOVE	Array Move	Copy a specified number of data elements from a source array to a destination array.	4-76
SRCH_EQ	Search Equal	Search for all array values equal to a specified value.	4-79
SRCH_NE	Search Not Equal	Search for all array values not equal to a specified value.	4-79
SRCH_GT	Search Greater Than	Search for all array values greater than a specified value.	4-79
SRCH_GE	Search Greater Than or Equal	Search for all array values greater than or equal to a specified value.	4-79
SRCH_LT	Search Less Than	Search for all array values less than a specified value.	4-79
SRCH_LE	Search Less Than or Equal	Search for all array values less than or equal to a specified value.	4-79

The maximum length allowed for these functions is 32767 bytes or words or 262136 bits (bits are available for ARRAY\_MOVE only).

Table functions operate on these types of data:

Data Type	Description
INT	Signed integer.
DINT	Double precision signed integer.
BIT *	Bit data type.
BYTE	Byte data type.
WORD	Word data type.

\* Only available for ARRAY\_MOVE.

The default data type is signed integer. The data type can be changed after selecting the specific data table function. To compare data of other types or of two different types, first use the appropriate conversion function (described in § 8., *Conversion Functions*) to change the data to one of the data types listed above.

## 7.1. ARRAY\_MOVE (INT, DINT, BIT, BYTE, WORD)

Use the Array Move (ARRAY\_MOVE) function to copy a specified number of data elements from a source array to a destination array.

The ARRAY\_MOVE function has five input parameters and two output parameters. When the function receives power flow, the number of data elements in the count indicator (N) is extracted from the input array starting with the indexed location (SR + SNX - 1). The data elements are written to the output array starting with the indexed location (DS + DNX - 1). The LEN operand specifies the number of elements that make up each array.

For ARRAY\_MOVE\_BIT, when word-oriented memory is selected for the parameters of the source array and/or destination array starting address, the least significant bit of the specified word is the first bit of the array. The value displayed contains 16 bits, regardless of the length of the array.

The indices in an ARRAY\_MOVE instruction are 1-based. In using an ARRAY\_MOVE, no element outside either the source or destination arrays (as specified by their starting address and length) may be referenced.

The ok output will receive power flow, unless one of the following conditions occurs:

- Enable is OFF.
- (N + SNX - 1) is greater than LEN.
- (N + DNX - 1) is greater than LEN.

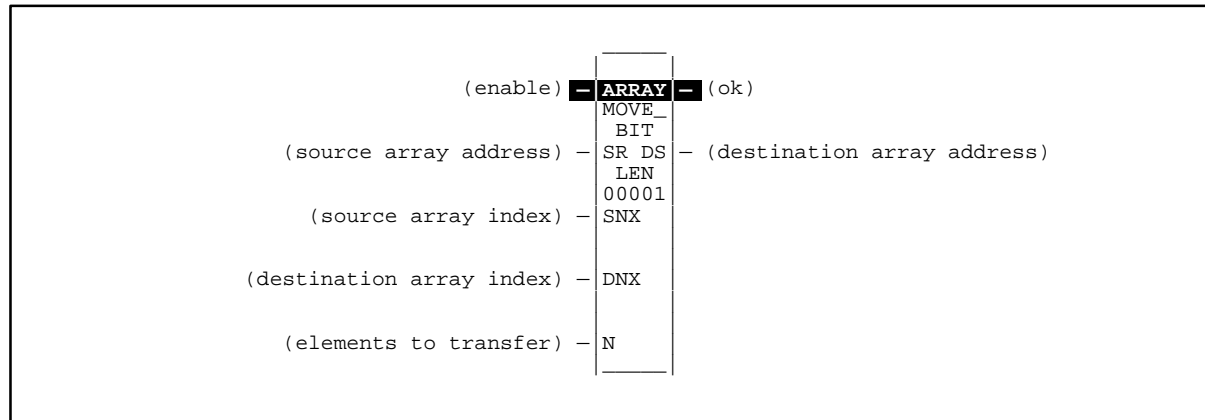

### 7.1.1. Parameters

Parameter	Description
enable	When the function is enabled, the operation is performed.
SR	SR contains the starting address of the source array. For ARRAY_MOVE_BIT, any reference may be used; it does not need to be byte aligned. However, 16 bits, beginning with the reference address specified, are displayed on–line.
SNX	SNX contains the index of the source array.
DNX	DNX contains the index of the destination array.
N	N provides a count indicator.
ok	The ok output is energized whenever enable is energized.
DS	DS contains the starting address of the destination array. For ARRAY_MOVE_BIT, any reference may be used; it does not need to be byte aligned. However, 16 bits, beginning with the reference address specified, are displayed on–line.
LEN	LEN specifies the number of elements starting at SR and DS that make up each array.

### 7.1.2. Valid Memory Types

Parameter	flow	%I	%Q	%M	%T	%S	%G	%R	%AI	%AQ	const	none
enable	•											
SR		o	o	o	o	Δ†	o	•	•	•		
SNX		•	•	•	•		•	•	•	•	•	
DNX		•	•	•	•		•	•	•	•	•	
N		•	•	•	•		•	•	•	•	•	
ok	•											•
DS		o	o	o	o	†	o	•	•	•		

- = Valid reference or place where power may flow through the function. For ARRAY\_MOVE\_BIT, discrete user references %I, %Q, %M and %T need not be byte aligned.
- o = Valid reference for INT, BIT, BYTE or WORD data only; not valid for DINT.
- Δ = Valid data type for BIT, BYTE or WORD data only; not valid for INT or DINT.
- † = %SA, %SB, %SC only; %S cannot be used.

**Example 1:**

In this example, if %R100=3 then %R0003 — %R0007 of the array %R0001 — %R0016 is read and is written into %R0104 — %R0108 of the array %R0100 — %R0115.

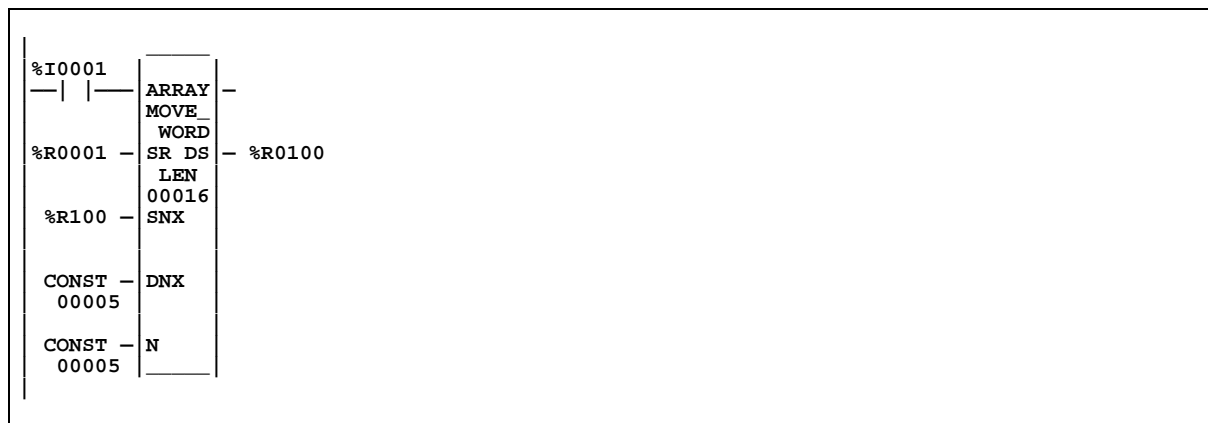

**Example 2:**

Using bit memory for SR and DS, %M0011 — %M0017 of the array %M0009 — %M0024 is read and then written to %Q0026 — %Q0032 of the array %Q0022 — %Q0037.

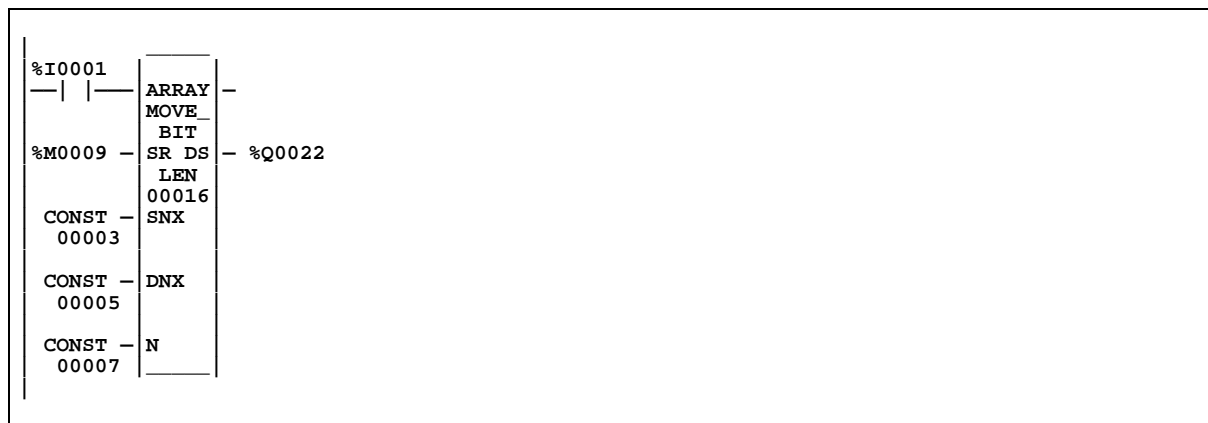

**Example 3:**

Using word memory, for SR and DS, the third least significant bit of %R0001 through the second least significant bit of %R0002 of the array containing all 16 bits of %R0001 and four bits of %R0002 is read and then written into the fifth least significant bit of %R0100 through the fourth least significant bit of %R0101 of the array containing all 16 bits of %R0100 and four bits of %R0101.

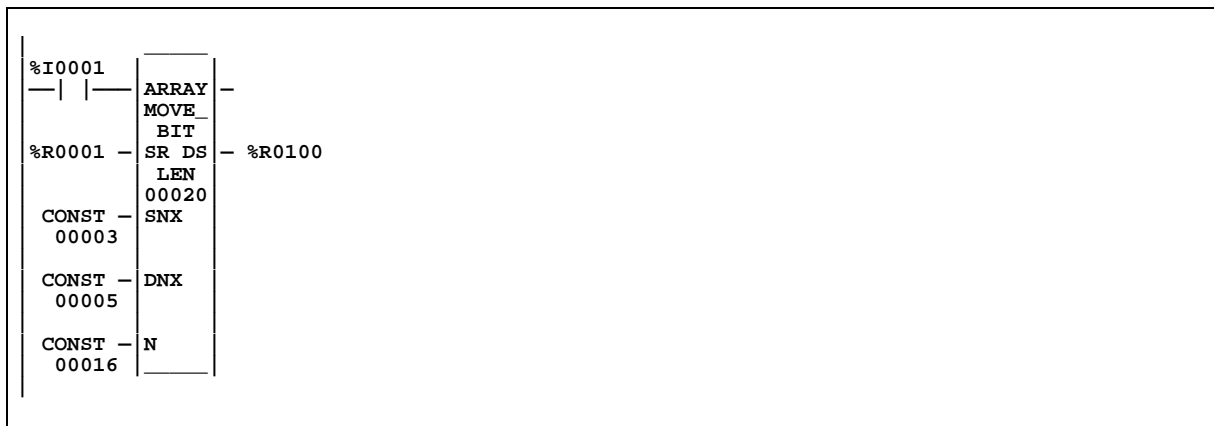

**7.2. SRCH\_EQ and SRCH\_NE (INT, DINT, BYTE, WORD)  
SRCH\_GT and SRCH\_LT  
SRCH\_GE and SRCH\_LE**

Use the appropriate Search function listed below to search for all array values for that particular operation.

Abbreviation	Function	Description
SRCH_EQ	Search Equal	Search for all array values equal to a specified value.
SRCH_NE	Search Not Equal	Search for all array values not equal to a specified value.
SRCH_GT	Search Greater Than	Search for all array values greater than a specified value.
SRCH_GE	Search Greater Than or Equal	Search for all array values greater than or equal to a specified value.
SRCH_LT	Search Less Than	Search for all array values less than a specified value.
SRCH_LE	Search Less Than or Equal	Search for all array values less than or equal to a specified value.

Each function has four input parameters and two output parameters. When the function receives power, the array is searched starting at (AR + input NX). This is the starting address of the array (AR) plus the index into this array (input NX).

The search continues until the array element of the search object (IN) is found or until the end of the array is reached. If an array element is found, output parameter (FD) is set ON and output parameter (output NX) is set to the relative position of this element within the array. If no array element is found before the end of the array is reached, then output parameter (FD) is set OFF and output parameter (output NX) is set to zero.

The valid values for input NX are 0 to LEN — 1. NX should be set to zero to begin searching at the first element. This value increments by one at the time of execution. Therefore, the values of output NX are 1 to LEN. If the value of input NX is out—of—range, (< 0 or ≥ LEN), its value is set to the default value of zero.

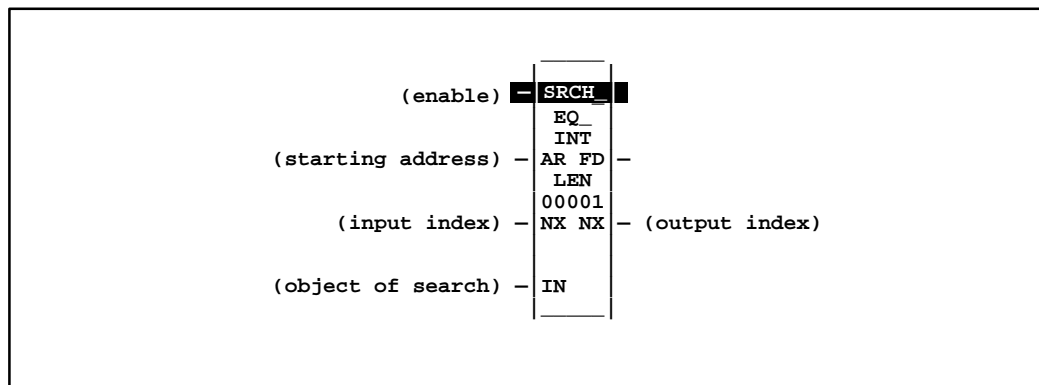

### 7.2.1. Parameters

Parameter	Description
enable	When the function is enabled, the operation is performed.
AR	AR contains the starting address of the array to be searched.
Input NX	Input NX contains the index into the array at which to begin the search.
IN	IN contains the object of the search.
Output NX	Output NX holds the position within the array of the search target.
FD	FD indicates that an array element has been found and the function was successful.
LEN	LEN specifies the number of elements starting at AR that make up the array to be searched. It may be 1 to 32767 bytes or words.

### 7.2.2. Valid Memory Types

Parameter	flow	%I	%Q	%M	%T	%S	%G	%R	%AI	%AQ	const	none
enable	•											
AR		o	o	o	o	Δ	o	•	•	•		
NX in		•	•	•	•		•	•	•	•	•	
IN		o	o	o	o	Δ	o	•	•	•	•	
NX out		•	•	•	•		•	•	•	•		
FD	•											•

- = Valid reference or place where power may flow through the function.
- o = Valid reference for INT, BYTE or WORD data only; not valid for DINT.
- Δ = Valid reference for BYTE or WORD data only; not valid for INT or DINT.

**Example 1**

The array AR is defined as memory addresses %R0001 — %R0005. When EN is ON, the portion of the array between %R0004 and %R0005 is searched for an element whose value is equal to IN. If %R0001 = 7, %R0002 = 9, %R0003 = 6, %R0004 = 7, %R0005 = 7 and %R0100 = 7, then the search will begin at %R0004 and conclude at %R0004 when FD is set ON and a 4 is written to %R0101.

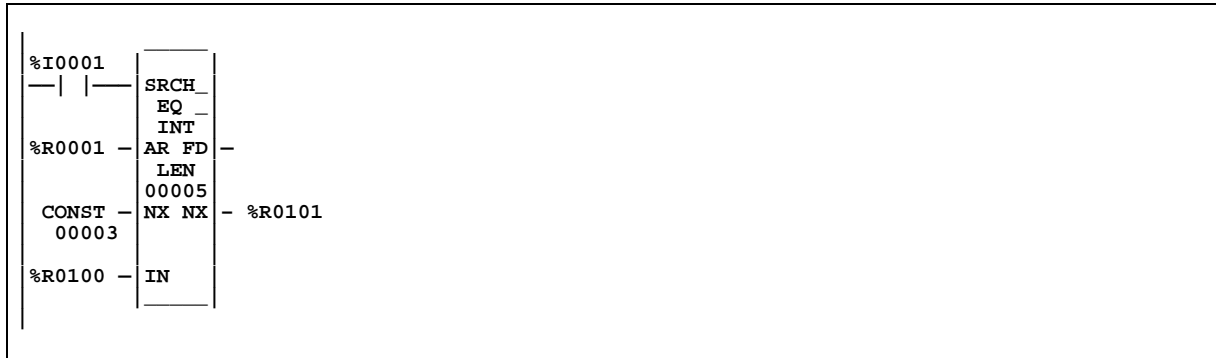

**Example 2**

Array AR is defined as memory addresses %AI001 — %AI016. The values of the array elements are 100, 20, 0, 5, 90, 200, 0, 79, 102, 80, 24, 34, 987, 8, 0 and 500. Initially, %AQ001 is 5. When EN is ON, each sweep will search the array looking for a match to the IN value of 0. The first sweep will start searching at %AI006 and find a match at %AI007, so FD is ON and %AQ001 is 7. The second sweep will start searching at %AI008 and find a match at %AI015, so FD remains ON and %AQ001 is 15. The next sweep will start at %AI016. Since the end of the array is reached without a match, FD is set OFF and %AQ001 is set to zero. The next sweep will start searching at the beginning of the array.



## 8. CONVERSION FUNCTIONS

Use the conversion functions to convert a data item from one number type to another. Many programming instructions, such as math functions, must be used with data of one type. This paragraph describes the following conversion functions:

Abbreviation	Function	Description	Page
BCD-4	Convert to BCD-4	Convert a signed integer to 4–digit BCD format.	4–82
INT	Convert to Signed Integer	Convert BCD–4 or REAL to signed integer format.	4–83
DINT	Convert to Double Precision Signed Integer	Convert REAL to double precision signed integer format.	4–85
REAL	Convert to REAL	Convert INT, DINT, BCD-4 or WORD to REAL.	4–86
WORD	Convert to WORD	Convert REAL to WORD format.	4–87
TRUN	Truncate	Round the real number toward zero.	4–88

### 8.1. →BCD–4 (INT)

The Convert to BCD–4 function is used to output the 4–digit BCD equivalent of signed integer data. The original data is not changed by this function. The output data can be used directly as input for another program function.

Data can be converted to BCD format to drive BCD–encoded LED displays or presets to external devices such as high–speed counters.

When the function receives power flow, it performs the conversion, making the result available via output Q. The function passes power flow when power is received, unless the specified conversion would result in a value that is outside the range 0 to 9999.

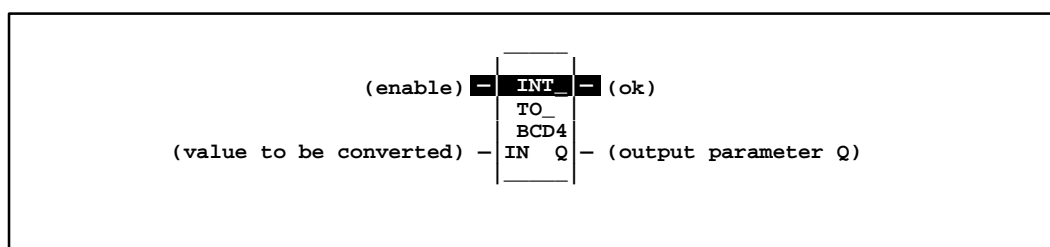

#### 8.1.1. Parameters

Parameter	Description
enable	When the function is enabled, the conversion is performed.
IN	IN contains a reference for the integer value to be converted to BCD–4.
ok	The ok output is energized when the function is performed without error.
Q	Output Q contains the BCD–4 form of the original value in IN.

### 8.1.2. Valid Memory Types

Parameter	flow	%I	%Q	%M	%T	%S	%G	%R	%AI	%AQ	const	none
enable	•											
IN		•	•	•	•		•	•	•	•	•	
ok	•											•
Q		•	•	•	•		•	•	•	•		

• = Valid reference or place where power may flow through the function.

#### Example

In the following example, whenever input %I0002 is set and no errors exist, the integer at input location %I0017 to %I0032 is converted to four BCD digits, and the result is stored in memory locations %Q0033 to %Q0048. Coil %Q1432 is used to check for successful conversion.

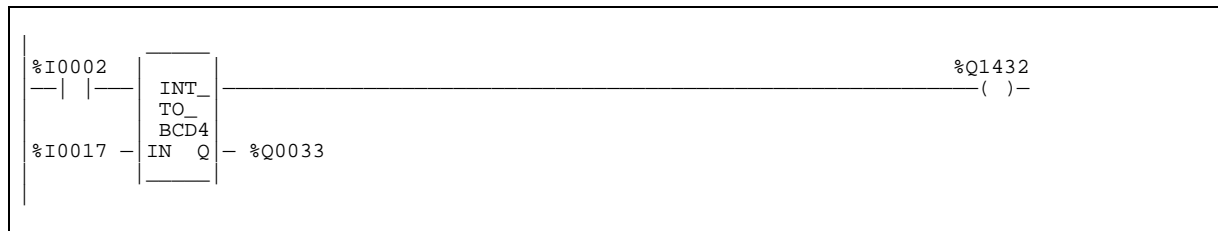

### 8.2. →INT (BCD-4, REAL)

The Convert to Signed Integer function is used to output the integer equivalent of BCD-4 or REAL data. The original data is not changed by this function. The output data can be used directly as input for another program function.

**Note**

The REAL data type is only available on 352 CPUs.

When the function receives power flow, it performs the conversion, making the result available via output Q. The function always passes power flow when power is received, unless the data is out of range.

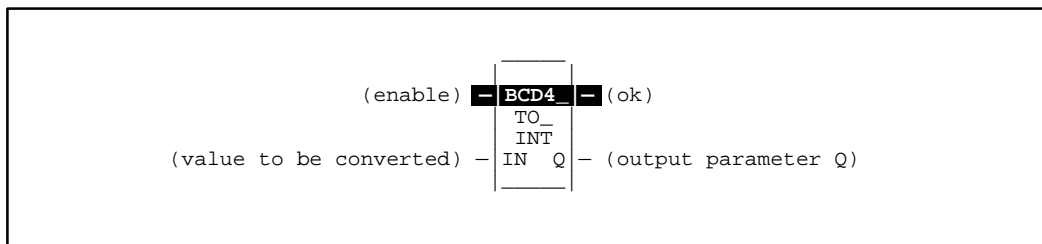

### 8.2.1. Parameters

Parameter	Description
enable	When the function is enabled, the conversion is performed.
IN	IN contains a reference for the BCD-4, REAL or Constant value to be converted to integer.
ok	The ok output is energized whenever enable is energized, unless the data is out of range or NaN (Not a Number).
Q	Output Q contains the integer form of the original value in IN.

### 8.2.2. Valid Memory Types

Parameter	flow	%I	%Q	%M	%T	%S	%G	%R	%AI	%AQ	const	none
enable	•											
IN		•	•	•	•		•	•	•	•	•	
ok	•											•
Q		•	•	•	•		•	•	•	•		

**Note:** For REAL data, the only valid types are %R, %AI and %AQ.

- = Valid reference or place where power may flow through the function.

#### Example

In the following example, whenever input %I0002 is set, the BCD-4 value in PARTS is converted to a signed integer and passed to the ADD function, where it is added to the signed integer value represented by the reference RUNNING. The sum is output by the ADD function to the reference TOTAL.

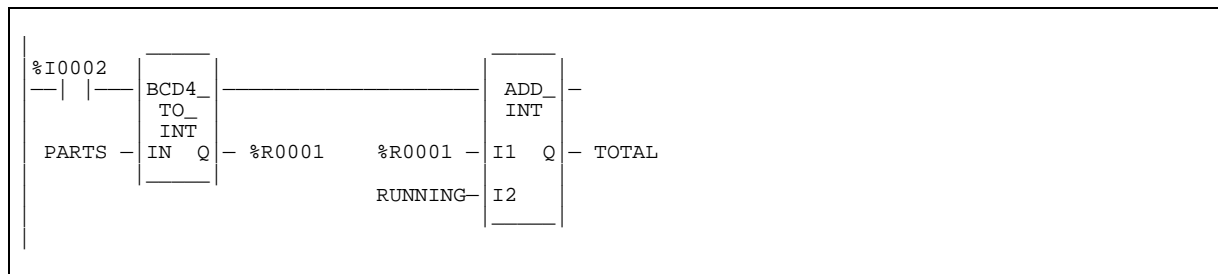

### 8.3. —>DINT (REAL)

The Convert to Double Precision Signed Integer function is used to output the double precision signed integer equivalent of real data. The original data is not changed by this function. The output data can be used directly as input for another program function.

When the function receives power flow, it performs the conversion, making the result available via output Q. The function always passes power flow when power is received, unless the real value is out of range.

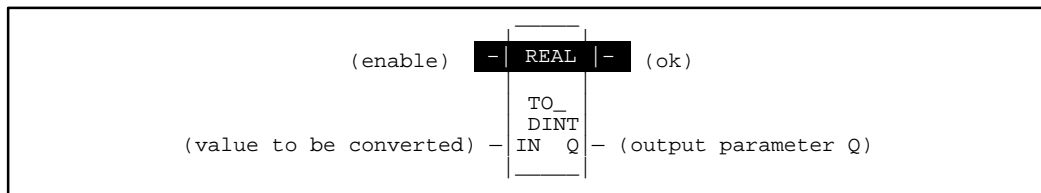

#### 8.3.1. Parameters

Parameter	Description
enable	When the function is enabled, the conversion is performed.
IN	IN contains a reference for the value to be converted to double precision integer.
ok	The ok output is energized whenever enable is energized, unless the real value is out of range.
Q	Q contains the double precision signed integer form of the original value in IN.

**Note**

It is possible for a loss of precision to occur when converting from REAL to DINT since the REAL has 24 significant bits.

### 8.3.2. Valid Memory Types

Parameter	flow	%I	%Q	%M	%T	%S	%G	%R	%AI	%AQ	const	none
enable	•											
IN		o	o	o	o		o	•	•	•	•	
ok	•											•
Q								•	•	•		

- Valid reference or place where power may flow through the function.

#### Example:

In the following example, whenever input %I0002 is set, the integer value at input location %I0017 is converted to a double precision signed integer and the result is placed in location %R0001. The output %Q1001 is set whenever the function executes successfully.

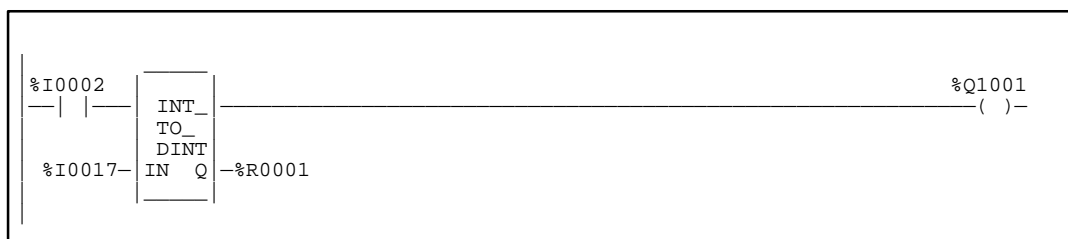

### 8.4. —>REAL (INT, DINT, BCD-4, WORD)

The Convert to Real function is used to output the real value of the input data. The original data is not changed by this function. The output data can be used directly as input for another program function.

When the function receives power flow, it performs the conversion, making the result available via output Q. The function passes power flow when power is received, unless the specified conversion would result in a value that is out of range.

It is possible for a loss of precision to occur when converting from DINT to REAL since the number of significant bits is reduced to 24.

**Note**

This function is only available on the 352 CPU.

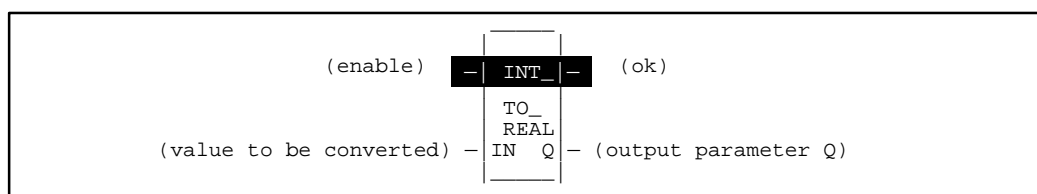

### 8.4.1. Parameters

Parameter	Description
enable	When the function is enabled, the conversion is performed.
IN	IN contains a reference for the integer value to be converted to REAL.
ok	The ok output is energized when the function is performed without error.
Q	Q contains the REAL form of the original value in IN.

### 8.4.2. Valid Memory Types

Parameter	flow	%I	%Q	%M	%T	%S	%G	%R	%AI	%AQ	const	none
enable	•											
IN		o	o	o	o		o	•	•	•	•	
ok	•											•
Q								•	•	•		

- Valid reference or place where power may flow through the function.
- o Not valid for DINT\_TO\_REAL.

**Example:**

In the following example, the integer value of input IN is 678. The result value placed in %T0016 is 678000.



### 8.5. —>WORD (REAL)

The Convert to WORD function is used to output the WORD equivalent of real data. The original data is not changed by this function.

**Note**

This function is only available on the 352 CPU.

When the function receives power flow, it performs the conversion, making the result available via output Q. The function passes power flow when power is received, unless the specified conversion would result in a value that is outside the range 0 to FFFFh.

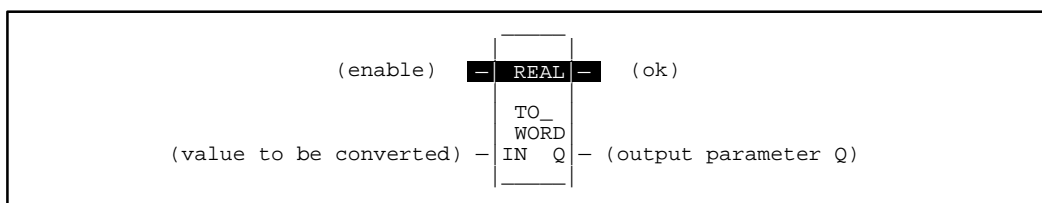

### 8.5.1. Parameters

Parameter	Description
enable	When the function is enabled, the conversion is performed.
IN	IN contains a reference for the value to be converted to WORD.
ok	The ok output is energized when the function is performed without error.
Q	Q contains the unsigned integer form of the original value in IN.

### 8.5.2. Valid Memory Types

Parameter	flow	%I	%Q	%M	%T	%S	%G	%R	%AI	%AQ	const	none
enable	•											
IN								•	•	•	•	
ok	•											•
Q		•	•	•	•		•	•	•	•		

- Valid reference or place where power may flow through the function.

#### Example:

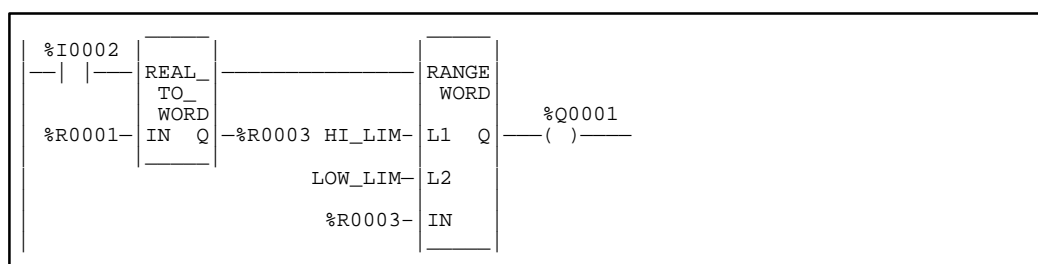

## 8.6. TRUN (INT, DINT)

The Truncate function is used to round the real number toward zero. The original data is not changed by this function. The output data can be used directly as input for another program function.

#### Note

The 352 CPUs are the only C80-35 CPUs with floating point capability; therefore, the TRUN function has no applicability for other C80-35 CPUs.

When the function receives power flow, it performs the conversion, making the result available via output Q. The function passes power flow when power is received, unless the specified conversion would result in a value that is out of range or unless IN is NaN (Not a Number).

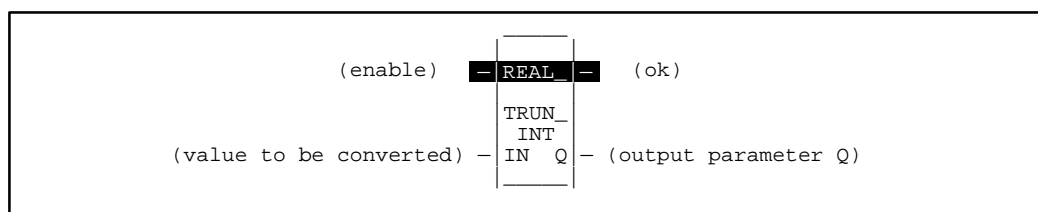

### 8.6.1. Parameters

Parameter	Description
enable	When the function is enabled, the conversion is performed.
IN	IN contains a reference for the real value to be truncated.
ok	The ok output is energized when the function is performed without error, unless the value is out of range or IN is NaN.
Q	Q contains the truncated INT or DINT value of the original value in IN.

**Note**

It is possible for a loss of precision to occur when converting from REAL to DINT since the REAL has 24 significant bits.

### 8.6.2. Valid Memory Types

Parameter	flow	%I	%Q	%M	%T	%S	%G	%R	%AI	%AQ	const	none
enable	•											
IN								•	•	•	•	
ok	•											•
Q		o	o	o	o		o	•	•	•		

- Valid reference or place where power may flow through the function.
- o Valid for REAL\_TRUN\_INT only.

**Example:**

In the following example, the displayed constant is truncated and the integer result 562 is placed in %T0001.



## 9. CONTROL FUNCTIONS

This paragraph describes the control functions, which may be used to limit program execution and alter the way the CPU executes the application program. (Refer to chapter 2, § 1., *PLC Sweep Summary*, for information on the CPU sweep.

Function	Description	Page
CALL	Causes program execution to go to a specified subroutine block.	4–91
DOIO	Services for one sweep a specified range of inputs or outputs immediately. (All inputs or outputs on a module are serviced if any reference locations on that module are included in the DO I/O function. Partial I/O module updates are not performed.) Optionally, a copy of the scanned I/O can be placed in internal memory, rather than the real input points.	4–92
END	Provides a temporary end of logic. The program executes from the first rung to the last rung or the END instruction, whichever is encountered first. This instruction is useful for debugging purposes, but it is not permitted in SFC programming (refer to the Note on page 4–97)	4–97
MCR and MCRN	Programs a Master Control Relay. An MCR causes all rungs between the MCR and its subsequent ENDMCR to be executed without power flow. Alspa P8–25/35/05 software supports two forms of the MCR function, a non-nested form (MCR) and a nested form (MCRN).	4–97
ENDMCR and ENDMCRN	Indicates that the subsequent logic is to be executed with normal power flow. Alspa P8–25/35/05 software supports two forms of the ENDMCR function, a non-nested form (ENDMCR) and a nested form (ENDMCRN).	4–100
JUMP and JUMPN	Causes program execution to jump to a specified location (indicated by a LABEL, see below) in the logic. Alspa P8–25/35/05 software supports two forms of the JUMP function, a non-nested form (JUMP) and a nested form (JUMPN).	4–101
LABEL and LABELN	Specifies the target location of a JUMP instruction. Alspa P8–25/35/05 software supports two forms of the LABEL function, a non-nested form (LABEL) and a nested form (LABELN).	4–103
COMMENT	Places a comment (rung explanation) in the program. After programming the instruction, the text can be typed in by “zooming” into the instruction.	4–104
SVCREQ	Requests one of the following special PLC services: <ul style="list-style-type: none"> <li>● Change/Read Task State and Number of Words to Checksum.</li> <li>● Change/Read Time-of-Day Clock.</li> <li>● Shut Down the PLC.</li> <li>● Clear Fault Tables.</li> <li>● Read Last-Logged Fault Table Entry.</li> <li>● Read Elapsed Time Clock.</li> <li>● Read I/O Override Status.</li> <li>● Read Master Checksum.</li> <li>● Interrogate I/O.</li> <li>● Read Elapsed Power Down Time.</li> </ul>	4–104
PID	Provides two PID (proportional/integral/derivative) closed-loop control algorithms: <ul style="list-style-type: none"> <li>● Standard ISA PID algorithm (PIDISA).</li> <li>● Independent term algorithm (PIDIND).</li> </ul>	4–123

## 9.1. CALL

Use the CALL function to cause program execution to go to a specified subroutine block.

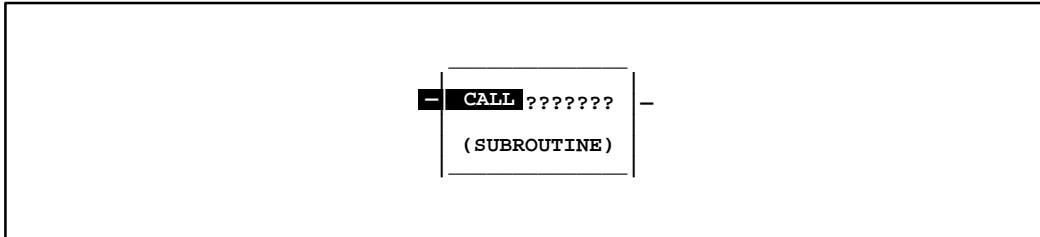

When the CALL function receives power flow, it causes the scan to go immediately to the designated subroutine block and execute it. After the subroutine block execution is complete, control returns to the point in the logic immediately following the CALL instruction.

### Example:

The following example screen shows the subroutine CALL instruction as it appears in the calling block. By positioning the cursor within the instruction, you can press **F10** to zoom into the subroutine.

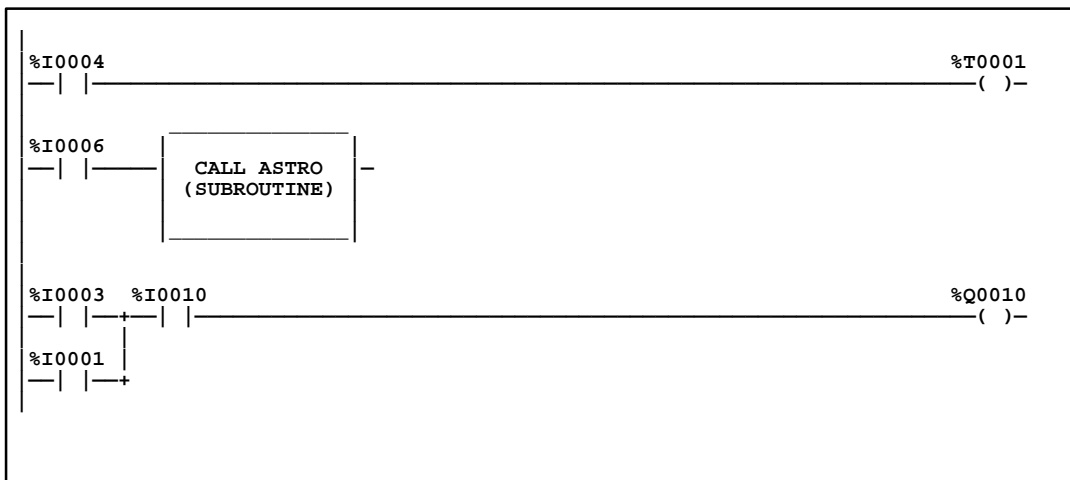

**Note**

The C80-05 Micro PLCs do not accommodate subroutines; therefore, the CALL function is inappropriate for use with a C80-05 Micro PLC.

## 9.2. DOIO

The DO I/O (DOIO) function is used to update inputs or outputs for one scan while the program is running. The DOIO function can also be used to update selected I/O during the program in addition to the normal I/O scan.

If input references are specified, the function allows the most recent values of inputs to be obtained for program logic. If output references are specified, DO I/O updates outputs based on the most current values stored in I/O memory. I/O is serviced in increments of entire I/O modules; the PLC adjusts the references, if necessary, while the function executes.

The DOIO function has four input parameters and one output parameter. When the function receives power flow and input references are specified, the input points at the starting reference (ST) and ending at END are scanned. If a reference is specified for ALT, a copy of the new input values is placed in memory, beginning at that reference, and the real input points are not updated. ALT must be the same size as the reference type scanned. If a discrete reference is used for ST and END, then ALT must also be discrete. If no reference is specified for ALT, the real input points are updated.

When the DOIO function receives power flow and output references are specified, the output points at the starting reference (ST) and ending at END are written to the output modules. If outputs should be written to the output modules from internal memory, other than %Q or %AQ, the beginning reference can be specified for ALT. The range of outputs written to the output modules is specified by the starting reference (ST) and the ending reference (END).

Execution of the function continues until either all inputs in the selected range have reported or all outputs have been serviced on the I/O cards. Program execution then returns to the next function following the DO I/O.

If the range of references includes an option module (HSC, APM, etc.), then all of the input data (%I and %AI) or all of the output data (%Q and %AQ) for that module will be scanned. The ALT parameter is ignored while scanning option modules. Also, the reference range must not include an Enhanced NCM (NCM+) module.

The function passes power to the right whenever power is received, unless:

- Not all references of the type specified are present within the selected range.
- The CPU is not able to properly handle the temporary list of I/O created by the function.
- The range specified includes I/O modules that are associated with a “Loss of I/O” fault.

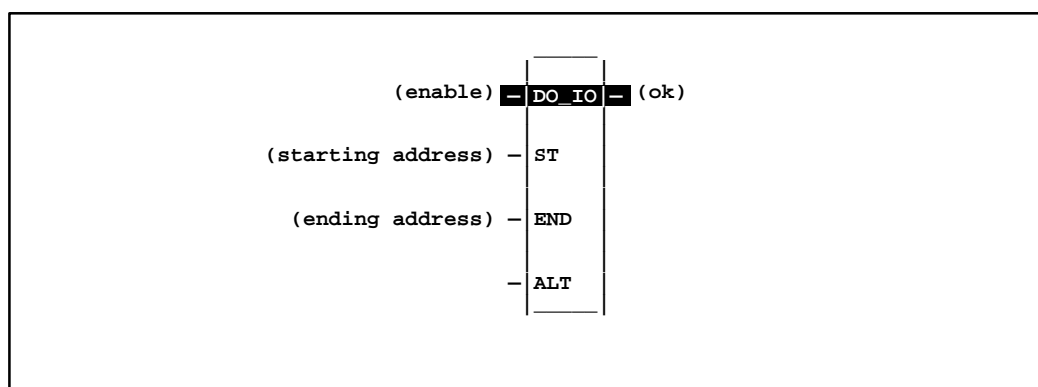

### 9.2.1. Parameters

Parameter	Description
enable	When the function is enabled, a limited input or output scan is performed.
ST	ST is the starting address or set of input or output points or words to be serviced.
END	END is the ending address or set of input or output points or words to be serviced.
ALT	For the input scan, ALT specifies the address to store scanned input point/word values. For the output scan, ALT specifies the address to get output point/word values from to send to the I/O modules. For Model 331 and higher CPUs, the ALT parameter can have an effect on speed of DOIO function block execution (see Note below and the paragraph on the enhanced DO I/O function for 331 and higher CPUs on page 4–95 § 9.2.3.) .
ok	The ok output is energized when the input or output scan completes normally.

**Note**

For Model 331 and higher CPUs, the ALT parameter of the DOIO function block can be used to enter the slot of a single module in the main rack. When that is done, the DOIO function block will execute in 80 microseconds instead of the 236 microseconds required when the block is programmed without the ALT parameter. No error checking is performed to prevent overlapping reference addresses or module type mismatches.

### 9.2.2. Valid Memory Types

Parameter	flow	%I	%Q	%M	%T	%S	%G	%R	%AI	%AQ	const	none
enable	•											
ST		•	•						•	•		
END		•	•						•	•		
ALT		•	•	•	•		•	•	•	•		•
ok	•											•

- = Valid reference or place where power may flow through the function.

#### Input Example 1:

In the following example, when the enabling input %I0001 is ON, references %I0001 to %I0064 are scanned and %Q0001 is turned on. A copy of the scanned inputs is placed in internal memory from reference %M0001 to %M0064. The real input points are not updated. This form of the function can be used to compare the current values of input points with the values of input points at the beginning of the scan.

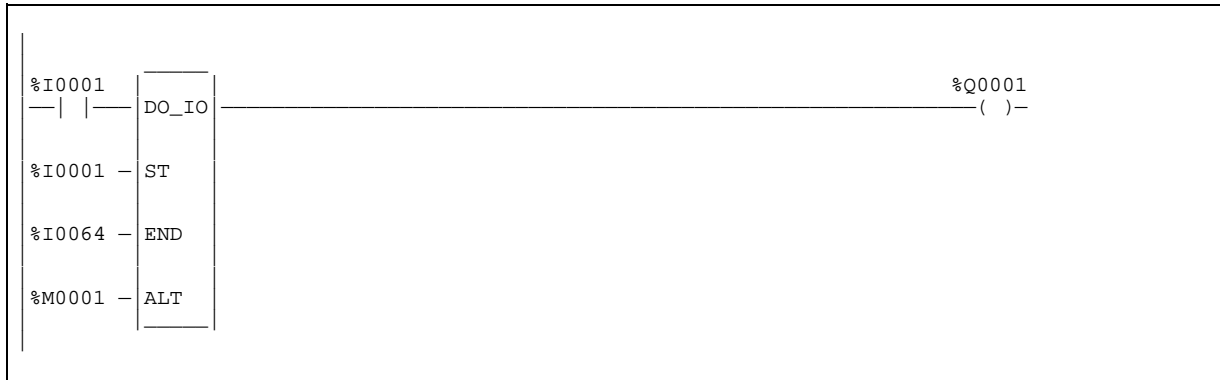

**Input Example 2:**

In the following example, when the enabling input %I0001 is ON, references %I0001 to %I0064 are scanned and %Q0001 is turned on. The scanned inputs are placed in the input status memory from reference %I0001 to %I0064. This form of the function allows input points to be scanned one or more times during the program execution portion of the CPU sweep.

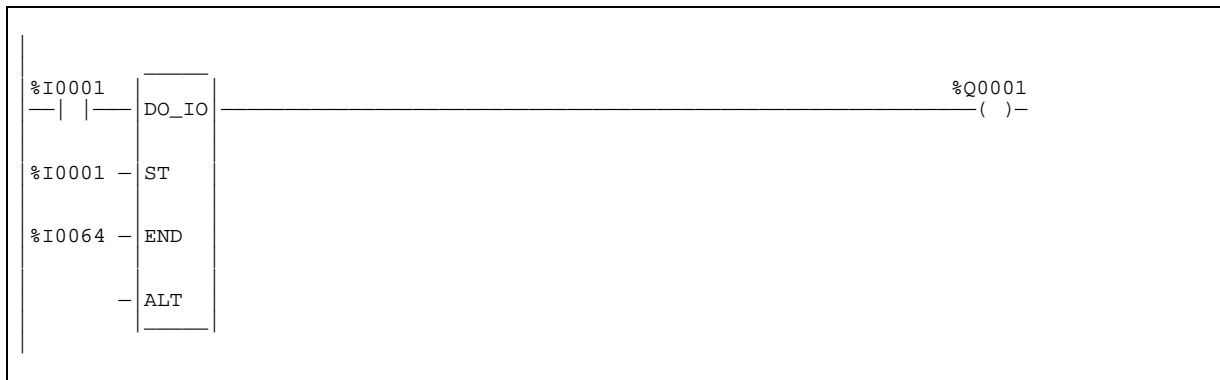

**Output Example 1:**

In the following example, when the enabling input %I0001 is ON, the values at references %R0001 to %R0004 are written to analog output channels %AQ001 to %AQ004 and %Q0001 is turned on. The values at %AQ001 to %AQ004 are not written to the analog output modules.

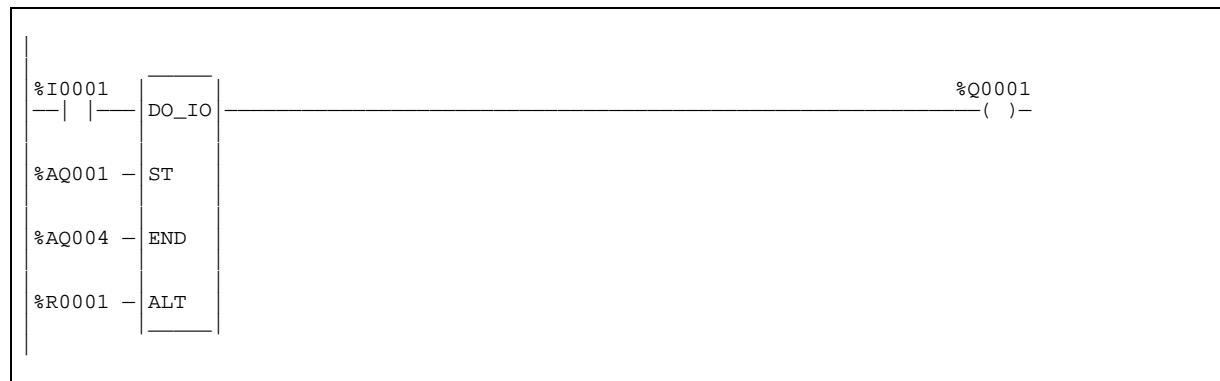

**Output Example 2:**

In the following example, when the enabling input %I0001 is ON, the values at references %AQ001 to %AQ004 are written to analog output channels %AQ001 to %AQ004 and %Q0001 is turned on.

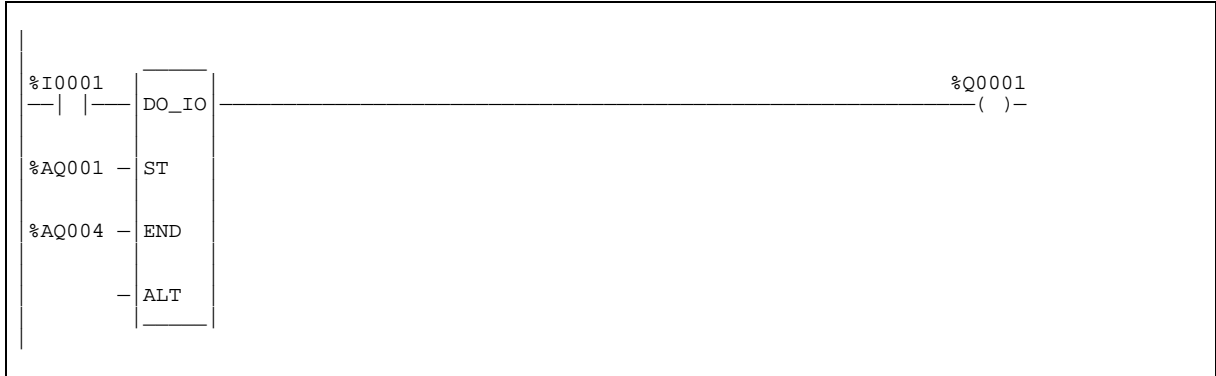

**9.2.3. Enhanced DO I/O Function for the 331 and Higher CPUs**

**Caution**

**If the Enhanced DO I/O function is used in a program, the program should not be loaded by a version of Alspa P8-25/35 software earlier than 4.01.**

An enhanced version of the DO I/O (DOIO) function is available for Release 4.20 or later of Models 331 and higher CPUs. This enhanced version of the DOIO function can only be used on a single discrete input or discrete output 8-point, 16-point or 32-point module.

The ALT parameter identifies the slot in the main rack that the module is located in. For example, a constant value of 2 in this parameter indicates to the CPU that it is to execute the enhanced version of the DOIO function block for the module in slot 2.

**Note**

The only checking done by the enhanced DOIO function block is to check the state of the module in the slot specified to see if the module is ok.

The enhanced DOIO function only applies to modules located in the main rack. Therefore, the ALT parameter must be between 2 and 5 for a 5-slot rack or 2 and 10 for a 10-slot rack.

The start and end references must be either %I or %Q. These references specify the first and last reference the module is configured for. For example, if a 16-point input module is configured at %I0001 to %I0016 in slot 10 of a 10-slot main rack, the ST parameter must be %I0001, the END parameter must be %I0016 and the ALT parameter must be 10, as shown below:

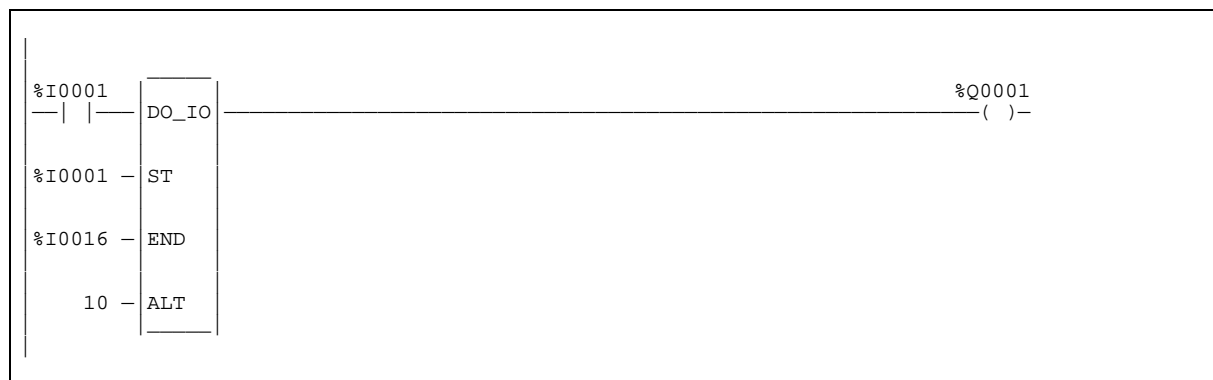

The following table compares the execution times of a normal DOIO function block for an 8-point 16-point or 32-point discrete input/output module with those of an enhanced DOIO function block.

Module	Normal DOIO Execution Time	Enhanced DOIO Execution Time
8-Pt Discrete Input Module 8-Pt Discrete Output Module	224 microseconds 208 microseconds	67 microseconds 48 microseconds
16-Pt Discrete Input Module 16-Pt Discrete Output Module	224 microseconds 211 microseconds	68 microseconds 47 microseconds
32-Pt Discrete Input Module 32-Pt Discrete Output Module	247 microseconds 226 microseconds	91 microseconds 50 microseconds

### 9.3. END

The END function provides a temporary end of logic. The program executes from the first rung to the last rung or the END function, whichever is encountered first.

The END function unconditionally terminates program execution. There can be nothing after the end function in the rung. No logic beyond the END function is executed and control is transferred to the beginning of the program for the next sweep.

The END function is useful for debugging purposes because it prevents any logic which follows from being executed.

Alspla P8 programming software provides an [ END OF PROGRAM LOGIC ] marker to indicate the end of program execution. This marker is used if no END function is programmed in the logic.

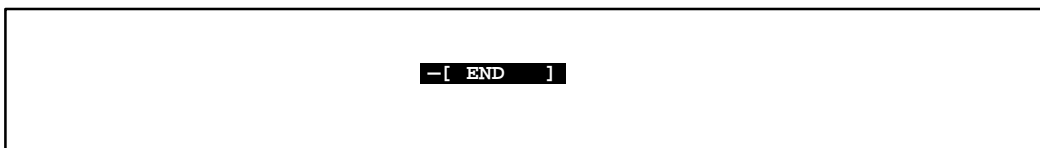

**Example:**

In the following example, an END is programmed to terminate the end of the current sweep.



**Note**

Placing an END function in SFC logic or in logic called by SFC produces an “END Function Executed from SFC Action” fault in Release 7 or later CPUs. (In pre-Release 7 CPUs, it did not work correctly, but no Fault was generated.) For information about this fault, refer to page 3-11.

### 9.4. MCR

All rungs between an active Master Control Relay (MCR) and its corresponding End Master Control Relay (ENDMCR) function are executed without power flow to coils. An ENDMCR function associated with the MCR is used to resume normal program execution. Unlike the JUMP instruction, MCRs can only occur in the forward direction. The ENDMCR instruction must appear after its corresponding MCR instruction in a program.

Alspla P8-25/35/05 software supports two forms of the MCR function, a non-nested and a nested form. The non-nested form has been available since Release 1 of the software and has the name MCR.

**Note**

Model 351 CPUs do not have the non-nested form, i.e., MCR. Use only the nested form, i.e., MCRN with 351 CPUs.

There can be only one MCR instruction for each ENDMCR instruction. The range for non-nested MCRs and ENDMCRs cannot overlap the range of any other MCR/ENDMCR pair or any JUMP/LABEL pair of instructions. Non-nested MCRs cannot be within the scope of any other MCR/ENDMCR pair or any JUMP/LABEL pair. In addition, a JUMP/LABEL pair or an MCR/ENDMCR pair cannot be within the scope of an MCR/ENDMCR pair.

**Note**

The non-nested MCR function is the only Master Control Relay function that can be used in a Release 1 C80–35 PLC. The nested MCR function should be used for all new applications.

The nested form of the MCR function has the name MCRN, and is available in Release 2 and later releases of C80–35 PLC. An MCRN function can be nested with other MCRN functions, provided they are nested correctly. An MCRN instruction and its corresponding ENDMCRN instruction must be contained completely within another MCRN/ENDMCRN pair.

An MCRN function can be placed anywhere within a program, as long as it is properly nested with respect to other MCRNs, and does not occur in the range of any non-nested MCR or non-nested JUMP.

**Note**

Use only **one** MCRN for each ENDMCRN with 351 CPUs.

There can be multiple MCRN functions corresponding to a single ENDMCRN (except for the 351 and 352 CPUs as noted above). This is analogous to the nested JUMP, where you can have multiple JUMPs to the same LABEL. For differences between the JUMP function and the MCR function, refer to the “Differences Between MCRs and Jumps” below.

Both forms of the MCR function have the same parameters. They both have an enable boolean input EN and also a name which identifies the MCR. This name is used again with an ENDMCR instruction. Neither the MCR nor the MCRN function has any outputs; there can be nothing after an MCR in a rung.

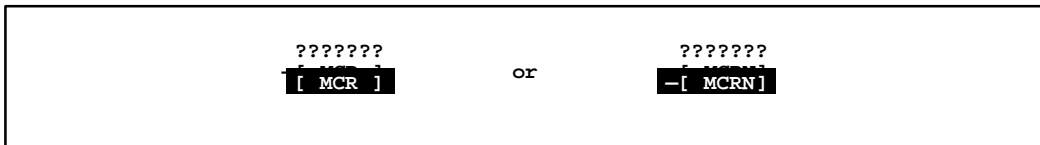

**Differences Between MCRs and JUMPs**

With an MCR function, function blocks within the scope of the MCR are executed *without power flow* and coils *are turned off*. In the following example, when %I0002 is ON, the MCR is enabled. When the MCR is enabled—even if %I0001 is ON—the ADD function block is executed *without* power flow (i.e., it does not add 1 to %R0001) and %Q0001 is turned OFF.

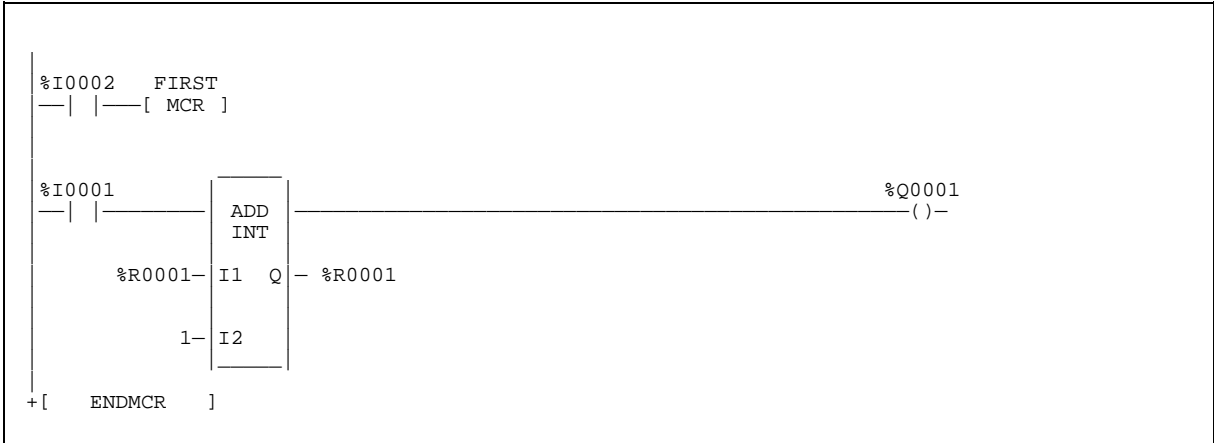

With a JUMP function, any function blocks between the JUMP and the LABEL *are not* executed and coils *are not affected*. In the following example, when %I0002 is ON, the JUMP is taken. Since the logic between the JUMP and the LABEL is skipped, %Q0001 is unaffected (i.e., if it was ON, it remains ON; if it was OFF, it remains OFF).

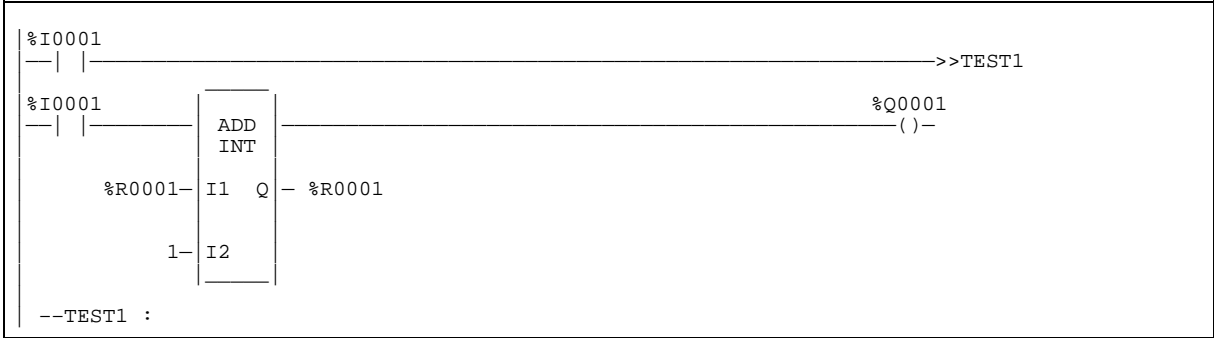

**Example**

In the following example, whenever %I0002 allows power flow into the MCR function, program execution will continue without power flow to the coils until the associated ENDMCR is reached. If %I0001 and %I0003 are ON, %Q0001 is turned OFF and %Q0003 remains ON.

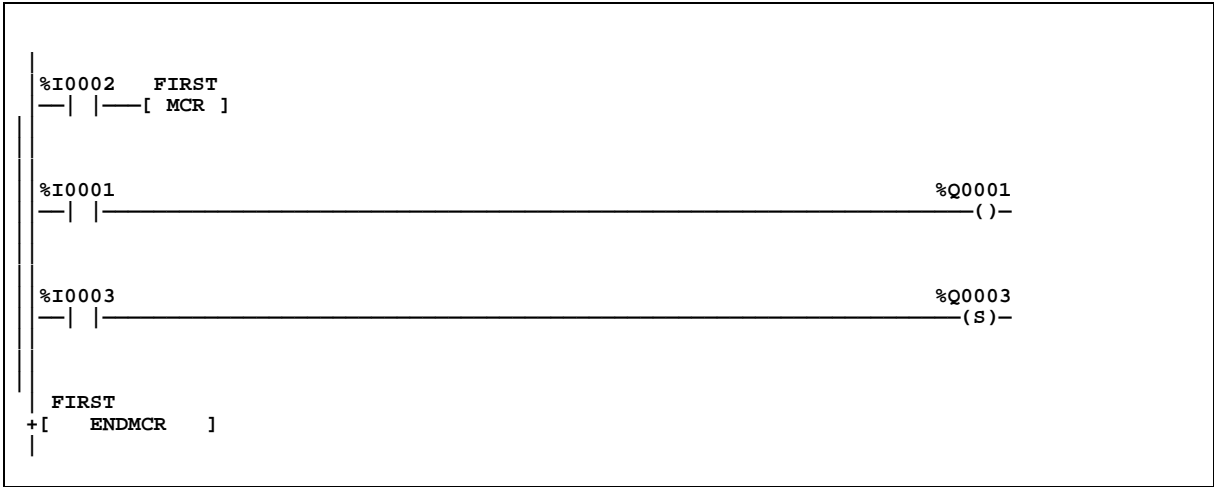

## 9.5. ENDMCR

Use the End Master Control Relay (ENDMCR) function to resume normal program execution after an MCR function. When the MCR associated with the ENDMCR is active, the ENDMCR causes program execution to resume with normal power flow. When the MCR associated with the ENDMCR is not active, the ENDMCR has no effect.

Alspla P8–25/35/05 software supports two forms of the ENDMCR function, a non-nested and a nested form. The non-nested form, ENDMCR, must be used with the non-nested MCR function, MCR. The nested form, ENDMCRN, must be used with the nested MCR function, MCRN.

The ENDMCR function has a negated boolean input EN. The instruction enable must be provided by the power rail; execution cannot be conditional. The ENDMCR function also has a name, which identifies the ENDMCR and associates it with the corresponding MCR(s). The ENDMCR function has no outputs; there can be nothing before or after an ENDMCR instruction in a rung.

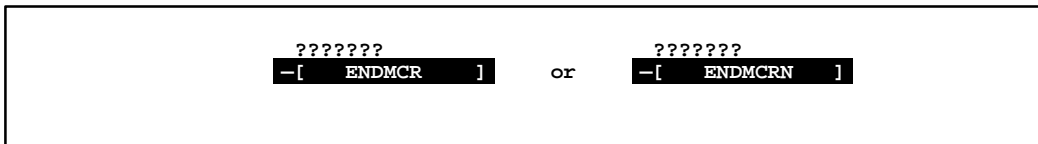

### Example:

In the following examples, an ENDMCR instruction is programmed to terminate MCR range “clear.”

Example of a non-nested ENDMCR:



Example of a nested ENDMCR:



## 9.6. JUMP

Use the JUMP instruction to cause a portion of the program logic to be bypassed. Program execution will continue at the LABEL specified. When the JUMP is active, all coils within its scope are left at their previous states. This includes coils associated with timers, counters, latches and relays.

Alspa P8-25/35/05 software supports two forms of the JUMP instruction, a non-nested and a nested form. The non-nested form has the form \_\_\_\_\_>>LABEL01, where LABEL01 is the name of the corresponding non-nested LABEL instruction.

For non-nested JUMPs, there can be only a single JUMP instruction for each LABEL instruction. The JUMP can be either a forward or a backward JUMP.

The range for non-nested JUMPs and LABELs cannot overlap the range of any other JUMP/LABEL pair or any MCR/ENDMCR pair of instructions. Non-nested JUMPs and their corresponding LABELs cannot be within the scope of any other JUMP/LABEL pair or any MCR/ENDMCR pair. In addition, an MCR/ENDMCR pair or another JUMP/LABEL pair cannot be within the scope of a non-nested JUMP/LABEL pair.

<b>Note</b>
-------------

The non-nested form of the JUMP instruction is the only JUMP instruction that can be used in a Release 1 C80-35 PLC. The nested JUMP function can be used (and is suggested for use) for all new applications.

Also, please note that the 351 and later CPUs support only nested jumps. Non-nested jumps are not supported on 351 and later CPUs.

The nested form of the JUMP instruction has the form \_\_\_\_\_N\_\_\_\_\_>>LABEL01, where LABEL01 is the name of the corresponding nested LABEL instruction. It is available in Release 2 and later releases of Alspa P8-35/25/05 software and PLC firmware.

A nested JUMP instruction can be placed anywhere within a program, as long as it does not occur in the range of any non-nested MCR or non-nested JUMP.

There can be multiple nested JUMP instructions corresponding to a single nested LABEL. Nested JUMPs can be either forward or backward JUMPs.

Both forms of the JUMP instruction are always placed in columns 9 and 10 of the current rung line; there can be nothing after the JUMP instruction in the rung. Power flow jumps directly from the instruction to the rung with the named label.

Non–nested JUMP:

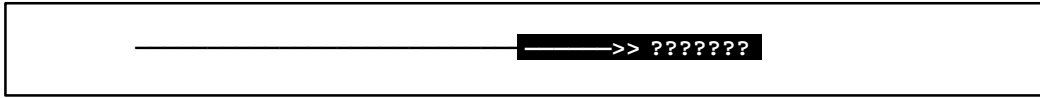

Nested JUMP:

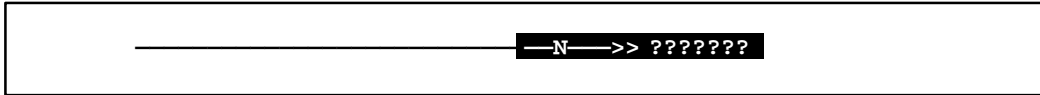

**Caution**

**To avoid creating an endless loop with forward and backward JUMP instructions, a backward JUMP must contain a way to make it conditional.**

**Example:**

In the following examples, whenever JUMP TEST1 is active, power flow is transferred to LABEL TEST1.

Example of a non–nested JUMP:

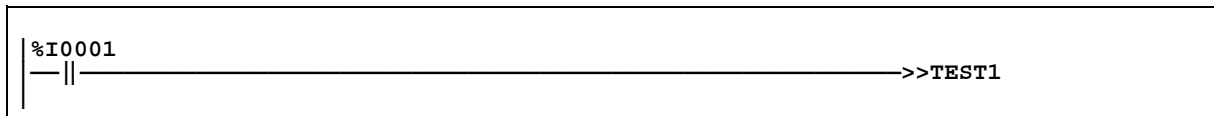

Example of a nested JUMP:

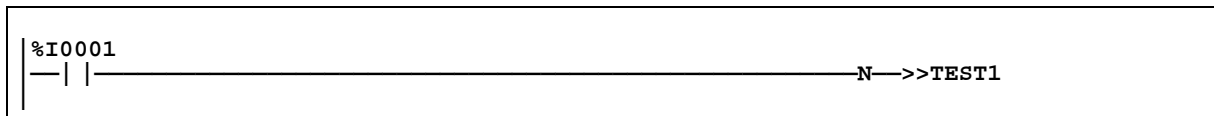

## 9.7. LABEL

The LABEL instruction functions as the target destination of a JUMP. Use the LABEL instruction to resume normal program execution after a JUMP instruction.

There can be only one LABEL with a particular label name in a program. Programs without a matched JUMP/LABEL pair can be created and stored to the PLC, but cannot be executed.

Alspla P8-25/35/05 software supports two forms of the LABEL function, a non-nested and a nested form. The non-nested form, LABEL01:, must be used with the non-nested JUMP function, \_\_\_\_\_>>LABEL01. The nested form, LABEL01:(nested), must be used with the nested JUMP function, \_\_\_\_\_N\_\_\_\_\_>>LABEL01.

The LABEL instruction has no inputs and no outputs; there can be nothing either before or after a LABEL in a rung.

Non-nested LABEL:

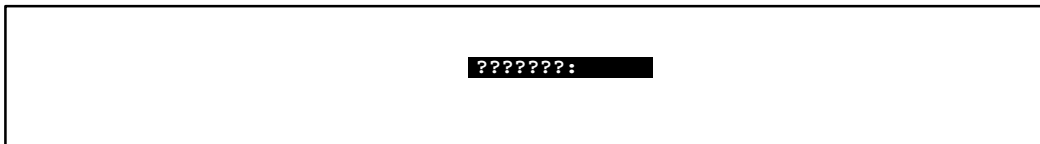

Nested LABEL:

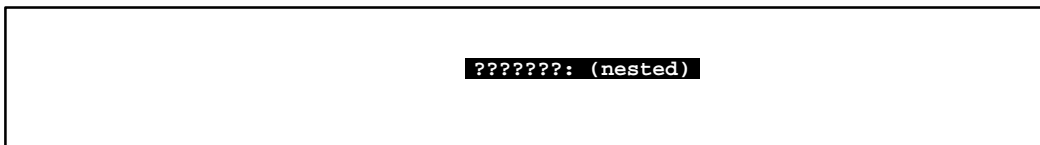

### Example:

In the following examples, power flow from JUMP TEST1 is resumed, starting at LABEL TEST1.

Example of a non-nested LABEL:



Example of a nested LABEL:



## 9.8. COMMENT

Use the COMMENT function to enter a comment (rung explanation) in the program. A comment can have up to 2048 characters of text. It is represented in the ladder logic like this:



The text can be read or edited by moving the cursor to (\* COMMENT \*) after accepting the rung and selecting **Zoom (F10)**. Comment text can also be printed.

Longer text can be included in printouts using an annotation text file, as described below:

1. Create the comment:
  - a. Enter text to the point where the text from the other file should begin.
  - b. Move the cursor to the beginning of a new line and enter **\I** or **\i**, the drive followed by a colon, the subdirectory or folder and the file name, as shown in this example:

**\I d:\text\commnt1**

The drive designation is not necessary if the file is located on the same drive as the program folder.

- c. Continue editing the program or exit to MS-DOS.
2. After exiting the programmer, create a text file using any MS-DOS compatible software package. Give the file the file name entered in the comment and place it on the drive specified in the comment.

## 9.9. SVCREQ

Use the Service Request (SVCREQ) function to request one of the following special PLC services:

**Table 4.3 – Service Request Functions**

Function	Description
6	Change/Read Checksum Task State and Number of Words to Checksum.
7	Change/Read Time-of-Day Clock.
13	Shut Down the PLC.
14	Clear Fault Tables.
15	Read Last-Logged Fault Table Entry.
16	Read Elapsed Time Clock.
18	Read I/O Override Status.
23	Read Master Checksum.
26/30	Interrogate I/O.
29	Read Elapsed Power Down Time.

The SVCREQ function has three input parameters and one output parameter. When the SVCREQ receives power flow, the PLC is requested to perform the function FNC indicated. Parameters for the function begin at the reference given for PARM. The SVCREQ function passes power flow unless an incorrect function number, incorrect parameters or out-of-range references are specified. Additional causes for failure are described on the pages that follow.

The reference given for PARM may represent any type of word memory (%R, %AI or %AQ). This reference is the first of a group that make up the “parameter block” for the function. Successive 16-bit locations store additional parameters. The total number of references required will depend on the type of SVCREQ function being used.

Parameter blocks may be used as both inputs for the function and the location where data may be output after the function executes. Therefore, data returned by the function is accessed at the same location specified for PARM.

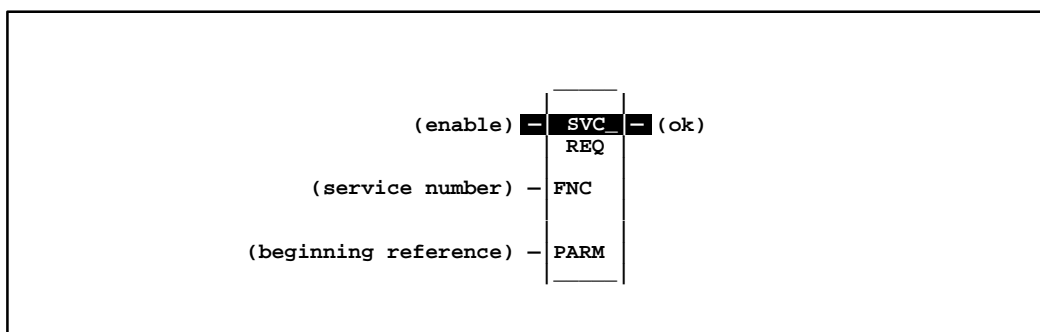

### 9.9.1. Parameters

Parameter	Description
enable	When enable is energized, the request service request is performed.
FNC	FNC contains the constant or reference for the requested service.
PARM	PARM contains the beginning reference for the parameter block for the requested service.
ok	The ok output is energized when the function is performed without error.

### 9.9.2. Valid Memory Types

Parameter	flow	%I	%Q	%M	%T	%S	%G	%R	%AI	%AQ	const	none
enable	•											
FNC		•	•	•	•		•	•	•	•	•	
PARM		•	•	•	•		•	•	•	•		
ok	•											•

- = Valid reference or place where power may flow through the function.

#### Example:

In the following example, when the enabling input %I0001 is ON, SVCREQ function number 7 is called, with the parameter block located starting at %R0001. Output coil %Q0001 is set ON if the operation succeeds.

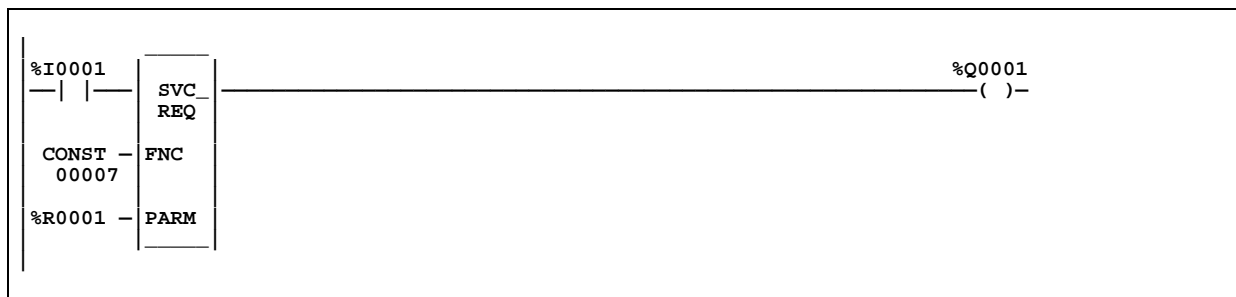

### 9.9.3. SVCREQ 6: Change/Read Number of Words to Checksum

Use the SVCREQ function with function number 6 in order to:

- Read the current word count.
- Set a new word count.

Successful execution will occur, unless some number other than 0 or 1 is entered as the requested operation (see below).

For the Checksum Task functions, the parameter block has a length of 2 words.

### 9.9.3.1. To Read the Current Word Count

Enter SVCREQ function 6 with this parameter block:

0	address
ignored	address + 1

After the function executes, the function returns the current checksum in the second word of the parameter block. No range is specified for the read function; the value returned is the number of words currently being checksummed.

0	address
current word count	address + 1

### 9.9.3.2. To Set a New Word Count

Enter SVCREQ function 6 with this parameter block:

1	address
new word count	address + 1

Entering 1 causes the PLC to adjust the number of words to be checksummed to the value given in the second word of the parameter block. For either the 331 or 311 CPU, the number can be either 0 or 8; in the 212 CPU, the value can be either 0 or 4.

**Note**

This Service Request is not available on C80-05 Micro PLCs.

**Example:**

In the following example, when enabling contact FST\_SCN is set, the parameter blocks for the checksum task function are built. Later in the program when input %I0137 turns on, the number of words being checksummed is read from the PLC operating system. This number is increased by 16, with the results of the ADD\_INT function being placed in the “hold new count for set” parameter. The second service request block requests the PLC to set the new word count.

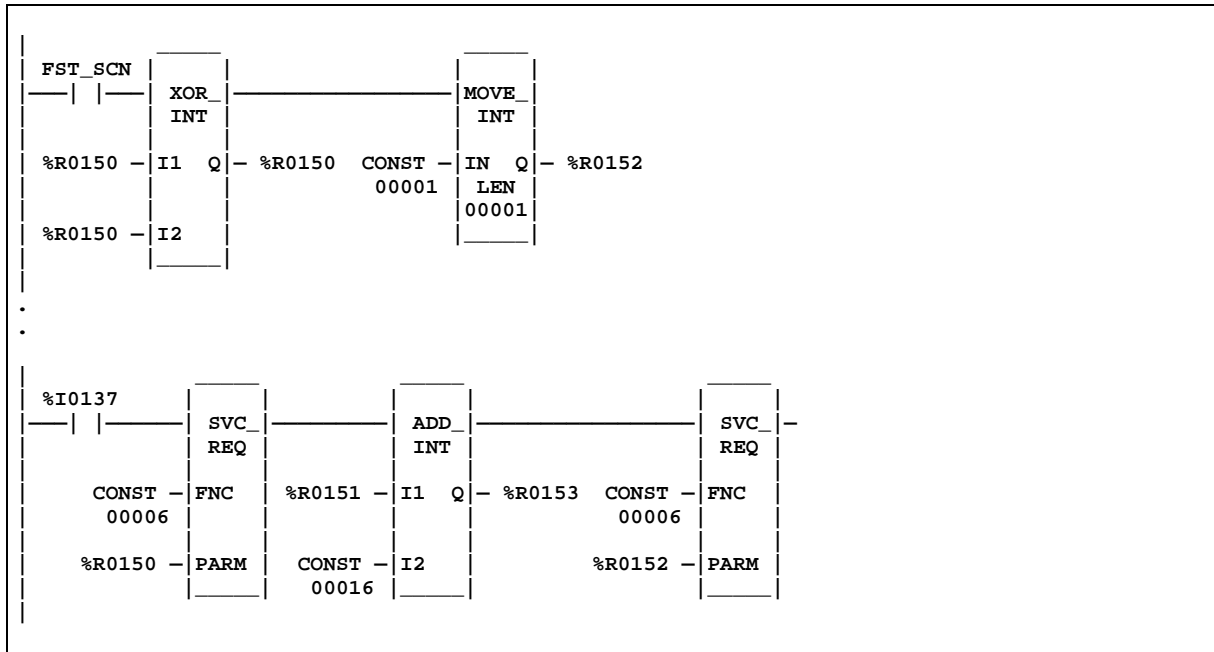

The example parameter blocks are located at address %R0150. They have the following content:

0 = read current count	%R0150
hold current count	%R0151
1 = set current count	%R0152
hold new count for set	%R0153

### 9.9.4. SVCREQ 7: Change/Read Time-of-Day Clock

Use the SVCREQ function with function number 7 in order to read and set the time-of-day clock in the PLC.

**Note**

This function is available only in 331 or higher CPUs.

Successful execution will occur unless:

1. Some number other than 0 or 1 is entered as the requested operation (see below).
2. An invalid data format is specified.
3. The data provided is not in the expected format.

For the date/time functions, the length of the parameter block depends on the data format. BCD format requires 6 words; packed ASCII requires 12 words.

0 = read time and date	address
1 = set time and date	
1 = BCD format	address + 1
3 = packed ASCII format	
data	address + 2 to end

In word 1, specify whether the function should read or change the values.

- 0 = read
- 1 = change

In word 2, specify a data format:

- 1 = BCD
- 3 = packed ASCII with embedded spaces and colons

Words 3 to the end of the parameter block contain output data returned by a read function or new data being supplied by a change function. In both cases, format of these data words is the same. When reading the date and time, words (address + 2) through (address + 8) of the parameter block are ignored on input.



### 9.9.4.1. Parameter Block Contents

Parameter block contents for the different data formats are shown on the following pages. For both data formats:

- Hours are stored in 24-hour format.
- Day of the week is a numeric value:

Value	Day of the Week
1	Sunday
2	Monday
3	Tuesday
4	Wednesday
5	Thursday
6	Friday
7	Saturday

### 9.9.4.2. To Change/Read Date and Time using BCD Format

In BCD format, each of the time and date items occupies a single byte. This format requires six words. The last byte of the sixth word is not used. When setting the date and time, this byte is ignored; when reading date and time, the function returns a null character (00).

High Byte                      Low Byte

Example output parameter block:  
Read Date and Time in BCD format  
(Sun., July 3, 1988, at 2:45:30 p.m.)

1 = change    or    0 = read		address	0	
1		address + 1	1	
month	year	address + 2	07	88
hours	day of month	address + 3	14	03
seconds	minutes	address + 4	30	45
(null)	day of week	address + 5	00	01

### 9.9.4.3. To Change/Read Date and Time using Packed ASCII with Embedded Colons Format

In Packed ASCII format, each digit of the time and date items is an ASCII formatted byte. In addition, spaces and colons are embedded into the data to permit it to be transferred unchanged to a printing or display device. This format requires 12 words.

High Byte	Low Byte	
1 = change	or	0 = read
3		address
year	year	address + 1
month	(space)	address + 2
(space)	month	address + 3
day of month	day of month	address + 4
hours	(space)	address + 5
:	hours	address + 6
minutes	minutes	address + 7
seconds	:	address + 8
(space)	seconds	address + 9
day of week	day of week	address + 10
		address + 11

Example output parameter block:  
 Read Date and Time in Packed ASCII Format  
 (Mon, Oct. 2, 1989 at 23:13:00)

0	
3	
39	38
31	20
20	30
32	30
32	20
3A	33
33	31
30	3A
20	30
33	30



### 9.9.6. SVCREQ 14: Clear Fault Tables

Use SVCREQ function 14 in order to clear either the PLC fault table or the I/O fault table. The SVCREQ output is set ON unless some number other than 0 or 1 is entered as the requested operation (see below).

For this function, the parameter block has a length of 1 word. It is an input parameter block only.

0 = clear PLC fault table.	address
1 = clear I/O fault table.	

#### Example:

In the following example, when input %I0346 is on and input %I0349 is on, the PLC fault table is cleared. When input %I0347 is on and input %I0349 is on, the I/O fault table is cleared. When input %I0348 is on and input %I0349 is on, both are cleared.

The parameter block for the PLC fault table is located at %R0500; for the I/O fault table the parameter block is located at %R0550. Both parameter blocks are set up elsewhere in the program.

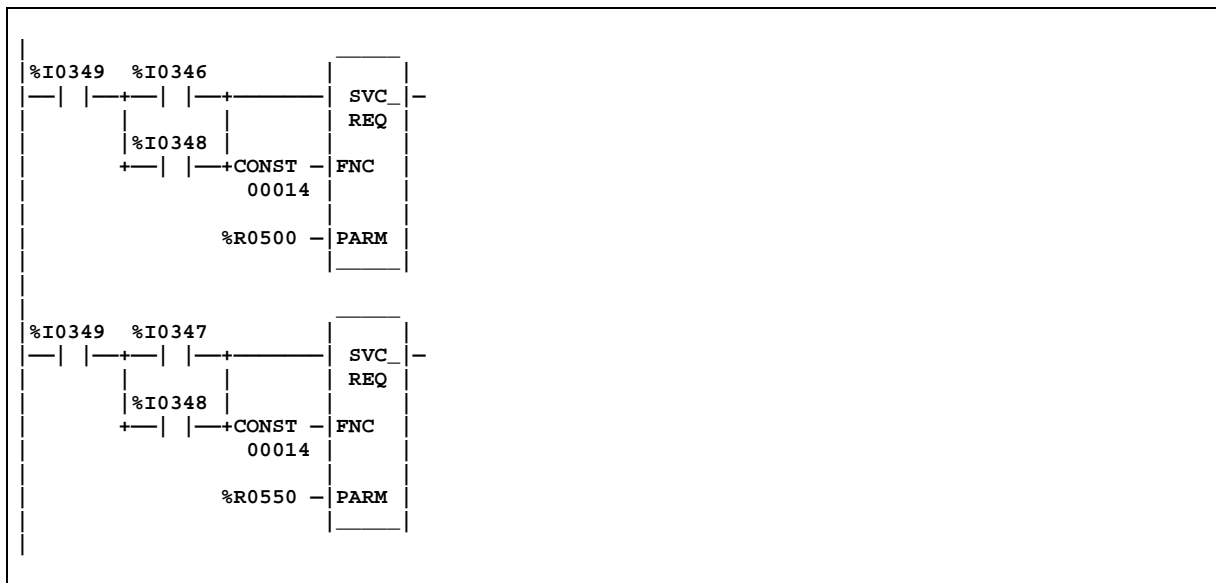



**Example 1:**

In the following example, when input %I0251 is on and input %I0250 is on, the last entry in the PLC fault table is read into the parameter block. When input %I0251 is off and input %I0250 is on, the last entry in the I/O fault table is read into the parameter block. The parameter block is located at location %R0600.

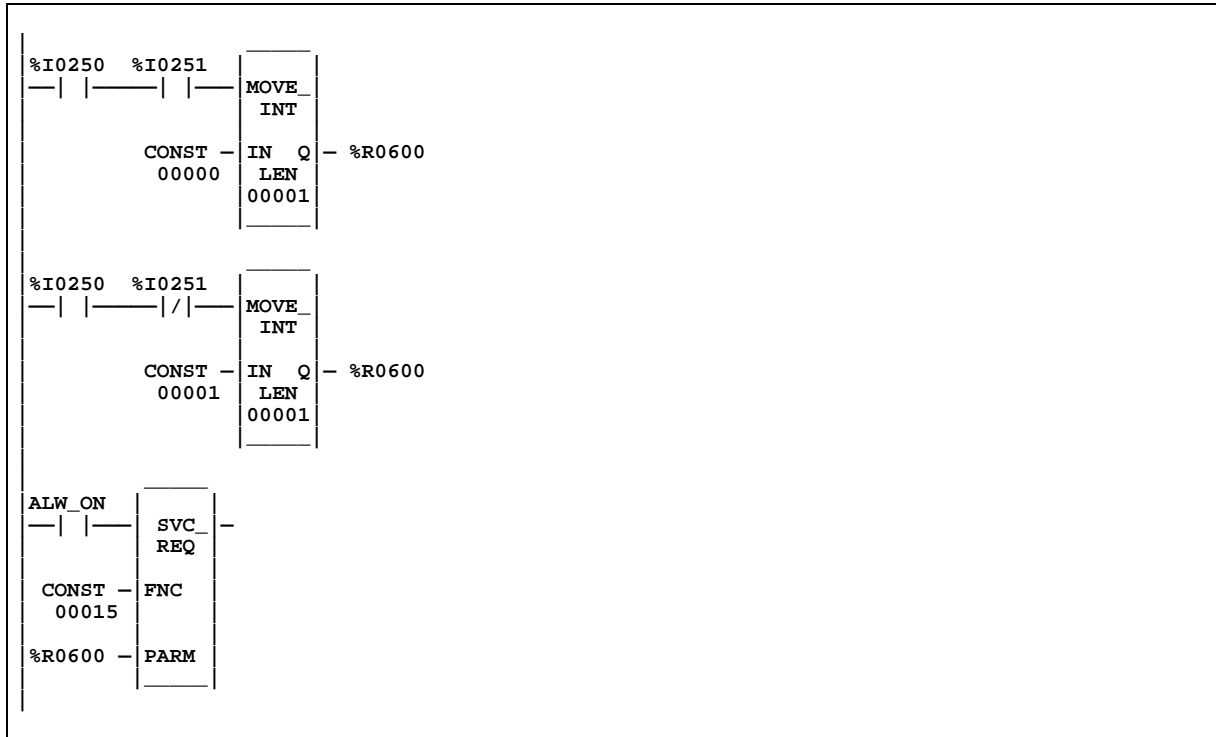

**Example 2:**

In the next example, the PLC is shut down when any fault occurs on an I/O module except when the fault occurs on modules in rack 0, slot 9 and in rack 1, slot 9. If faults occur on these two modules, the system remains running. The parameter for “table type” is set up on the first sweep. The contact IO\_PRES, when set, indicates that the I/O fault table contains an entry. The PLC CPU sets the normally open contact in the sweep after the fault logic places a fault in the table. If faults are placed in the table in two consecutive sweeps, the normally open contact is set for two consecutive sweeps.

The example uses a parameter block located at %R0600. After the SVCREQ function executes, the fourth, fifth, and sixth words of the parameter block contain the address of the I/O module that faulted:

1		%R00600
long/short		%R00601
referenceaddress		%R00602
rack number	slot number	%R00603
I/O bus no.	bus address	%R00604
point address	fault data	%R00605

In the program, the EQ\_INT blocks compare the rack/slot address in the table to hexadecimal constants. The internal coil %M0007 is turned on when the rack/slot where the fault occurred meets the criteria specified above. If %M0007 is on, its normally closed contact is off, preventing the shutdown. Conversely, if %M0007 is off because the fault occurred on a different module, the normally closed contact is on and the shutdown occurs.

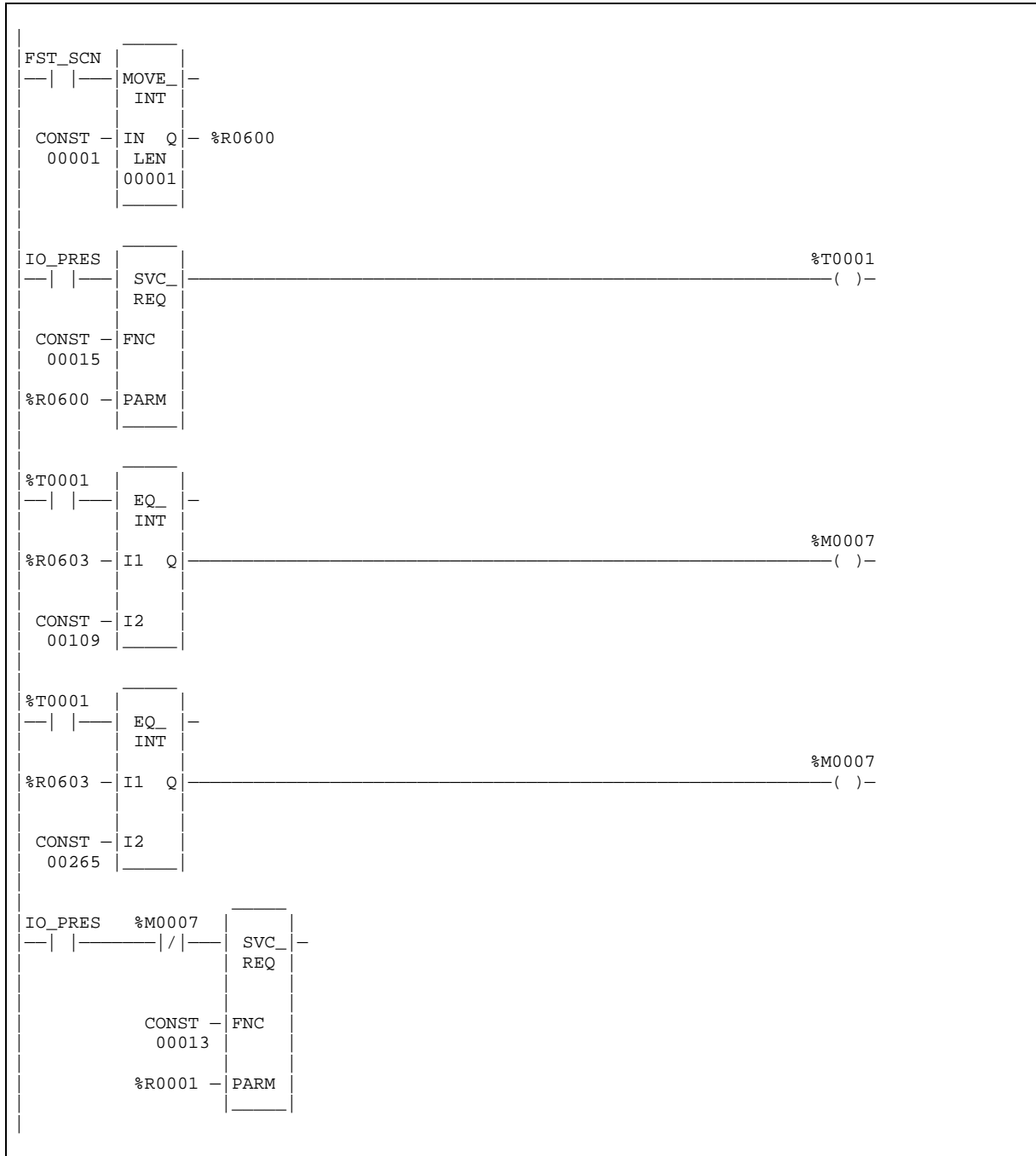

### 9.9.8. SVCREQ 16: Read Elapsed Time Clock

Use the SVCREQ function with function number 16 in order to read the value of the system's elapsed time clock. This clock tracks elapsed time in seconds since the PLC powered on. The timer will roll over approximately once every 100 years.

This function has an output parameter block only. The parameter block has a length of 3 words.

seconds from power on (low order)	address
seconds from power on (high order)	address + 1
100 microsecond ticks	address + 2

The first two words are the elapsed time in seconds. The last word is the number of 100 microsecond ticks in the current second.

#### Example:

In the following example, when internal coil %M0233 is on, the value of the elapsed time clock is read and coil %M0234 is set. When it is off, the value is read again. The difference between the values is then calculated, and the result is stored in register memory at location %R0250.

The parameter block for the first read is at %R0127; for the second read, at %R0131. The calculation ignores the number of hundred microsecond ticks and the fact that the DINT type is actually a signed value. The calculation is correct until the time since power—on reaches approximately 50 years.

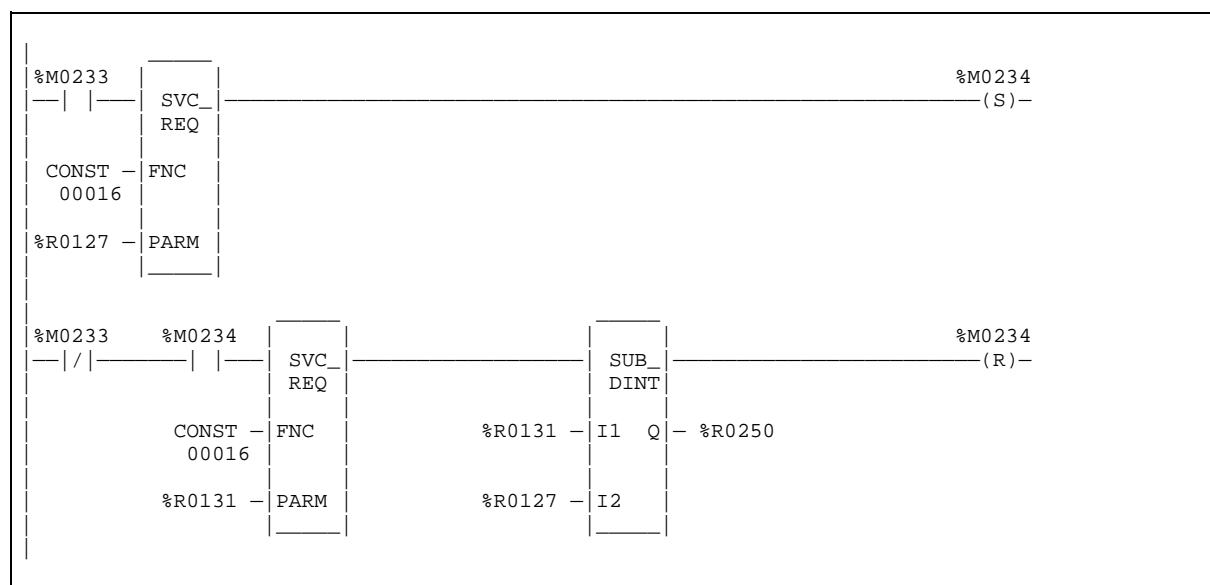

### 9.9.9. SVCREQ 18: Read I/O Override Status

Use SVCREQ function 18 in order to read the current status of overrides in the CPU.

**Note**

This feature is available **only** for 331 or higher CPUs.

For this function, the parameter block has a length of 1 word. It is an output parameter block only.

0 = No overrides are set.	address
1 = Overrides are set.	

**Note**

SVCREQ 18 reports only overrides of %I and %Q references.

**Example:**

In the following example, the status of I/O overrides is always read into location %R1003. If any overrides are present, output %T0001 is set on.

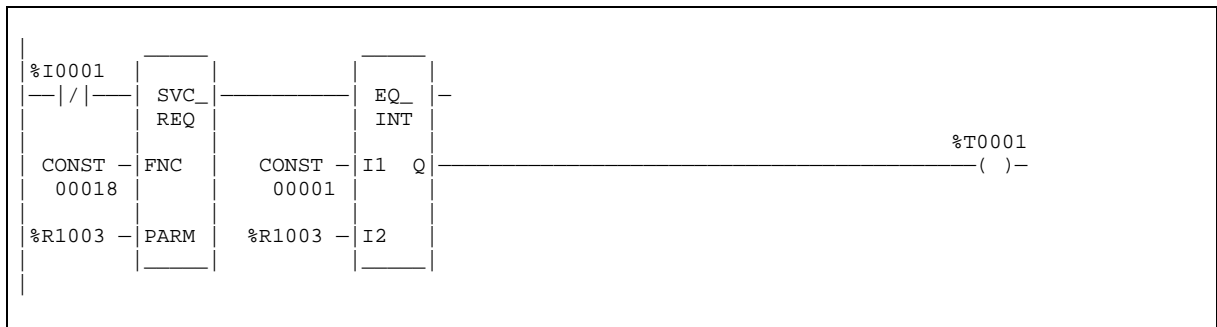

### 9.9.10. SVCREQ 23: Read Master Checksum

Use SVCREQ function 23 to read the master checksums for the user program and the configuration. The SVCREQ output is always set to ON if the function is enabled, and the output block of information (see below) starts at the address given in parameter 3 (PARM) of the SVCREQ function.

When a **RUN MODE STORE** is active, the program checksums may not be valid until the store is complete. Therefore, two flags are provided at the beginning of the output parameter block to indicate when the program and configuration checksums are valid.

For this function, the output parameter block has a length of 12 words with this format:

Master Program Checksum Valid (0 = not valid, 1 = valid)	address
Master Configuration Checksum Valid (0 = not valid, 1 = valid)	address + 1
Number of Program Blocks (including _MAIN)	address + 2
Size of User Program in Bytes (DWORD data type)	address + 3
Program Additive Checksum	address + 5
Program CRC Checksum (DWORD data type)	address + 6
Size of Configuration Data in Bytes	address + 8
Configuration Additive Checksum	address + 9
Configuration CRC Checksum (DWORD data type)	address + 10

#### Example:

In the following example, when input %I0251 is ON, the master checksum information is placed into the parameter block, and the output coil (%Q0001) is turned on. The parameter block is located at %R0050.

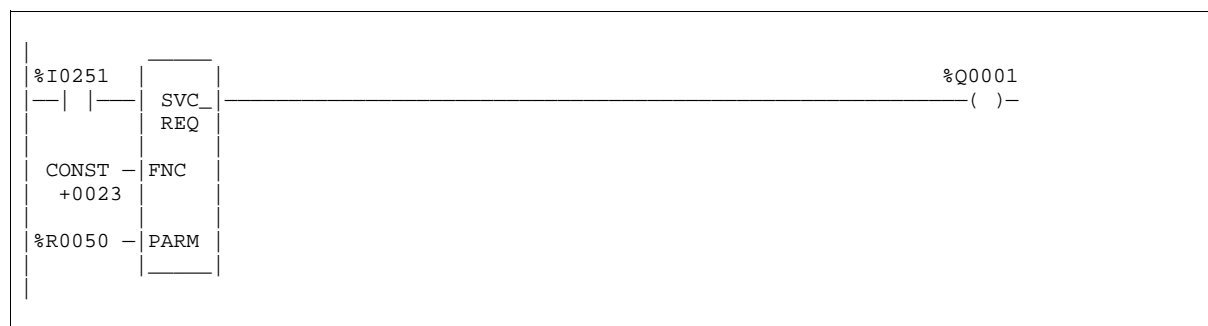

### 9.9.11. SVCREQ 26/30: Interrogate I/O

Use SVCREQ function 26 (or 30—they are identical; i.e., you can use either number to accomplish the same thing) to interrogate the actual modules present and compare them with the rack/slot configuration, generating addition, loss and mismatch alarms, as if a store configuration had been performed. This SVCREQ will generate faults on both the PLC and I/O fault tables, depending on the fault.

This function has no parameter block and always outputs power flow.

**Note**

The time for this SVCREQ to execute depends on how many faults exist. Therefore, execution time of this SVCREQ will be greater for situations where more modules are at fault.

**Example:**

In the following example, when input %I0251 is ON, the actual modules are interrogated and compared to the rack/slot configuration. Output %Q0001 is turned on after the SVCREQ is complete.

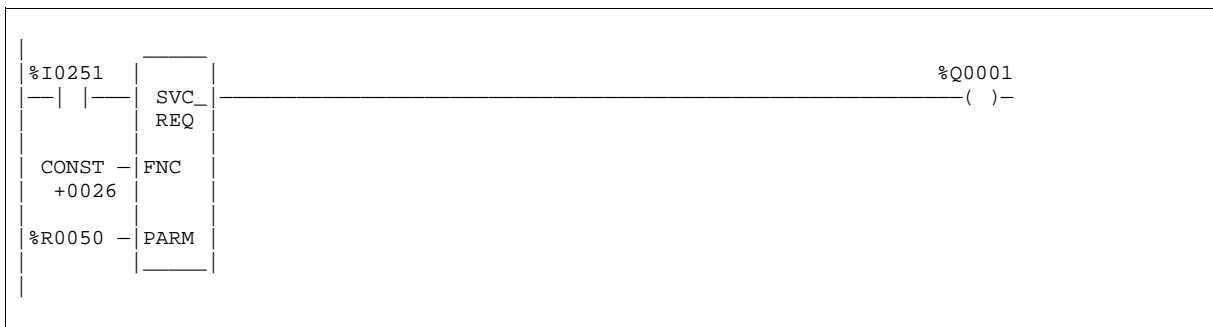

**Note**

This Service Request is not available on C80-05 Micro PLCs.

### 9.9.12. SVCREQ 29: Read Elapsed Power Down Time

Use the SVCREQ function 29 to read the the amount of time elapsed between the last power-down and the most recent power-up. The SVCREQ output is always set to ON, and the output block of information (see below) starts at the address given in parameter 3 (PARM) of the SVCREQ function.

**Note**

This function is available only in the 331 or higher CPUs.

This function has an output parameter block only. The parameter block has a length of 3 words.

Power-Down Elapsed Seconds (low order)	address
Power-Down Elapsed Seconds (high order)	address + 1
100 Microsecond ticks	address + 2

The first two words are the power-down elapsed time in seconds. The last word is the remaining power-down elapsed time in 100 microsecond ticks (which is always 0). Whenever the PLC can not properly calculate the power down elapsed time, the time will be set to 0. This will happen when the PLC is powered up with CLR M/T pressed on the HHP. This will also happen if the watchdog timer times out before power-down.

**Example:**

In the following example, when input %I0251 is ON, the Elapsed Power-Down Time is placed into the parameter block and the output coil (%Q0001) is turned on. The parameter block is located at %R0050.

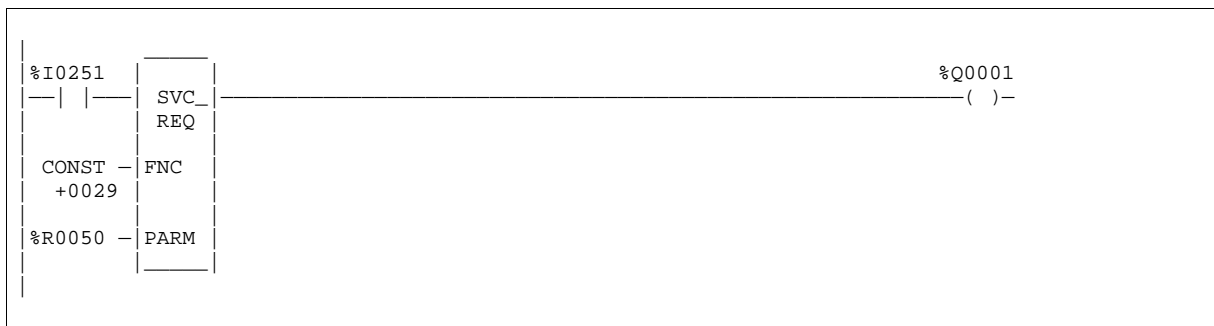

## 9.10. PID

The Proportional plus Integral plus Derivative (PID) control function is the best known general purpose algorithm for closed loop process control. The Alspla P8 PID function block compares a Process Variable feedback with a desired process Set Point and updates a Control Variable output based on the error.

The block uses PID loop gains and other parameters stored in an array of 4016 bit words (discussed on § 9.10.3.) to solve the PID algorithm at the desired time interval. All parameters are 16 bit integer words for compatibility with 16 bit analog process variables. This allows %AI memory to be used for input Process Variables and %AQ to be used for output Control Variables. The example shown below includes typical inputs.

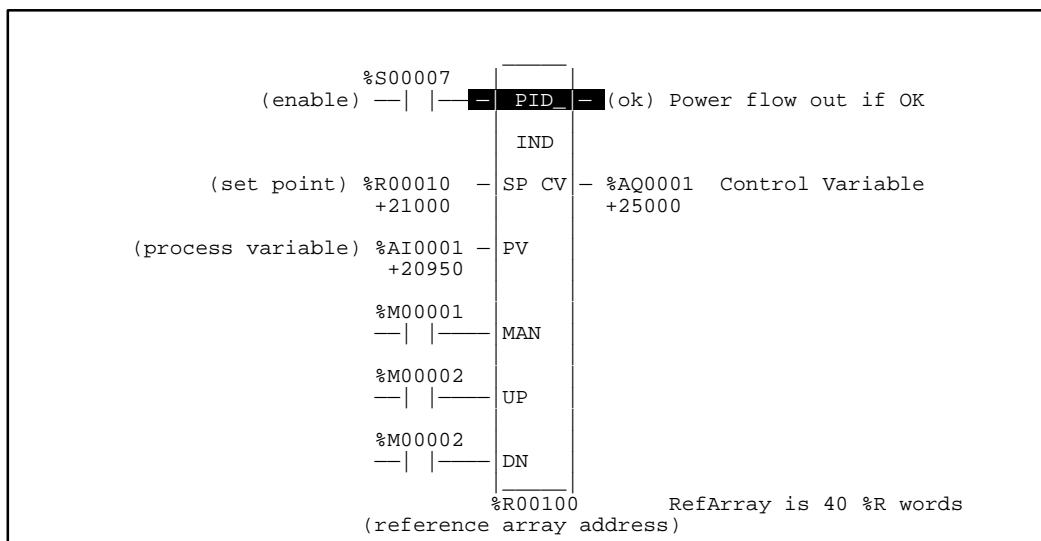

As the input Set Point and Process Variable and output Control Variable terms are used so frequently, they will be abbreviated as SP, PV and CV. As scaled 16 integer numbers, many parameters must be defined in either PV counts or units or CV counts or units. For example, the SP input must be scaled over the same range as PV as the PID block calculates the error by subtracting these two inputs. The PV and CV Counts may be -32000 or 0 to 32000 matching analog scaling or from 0 to 10000 to display variables as 0.00% to 100.00%. The PV and CV Counts do not have to have the same scaling, in which case there will be scale factors included in the PID gains.

**Note**

The PID will not execute more often than once every 10 milliseconds. This could change your desired results if you set it up to execute every sweep and the sweep is under 10 milliseconds. In such a case, the PID function will not run until enough sweeps have occurred to accumulate an elapsed time of 10 milliseconds; e.g., if the sweep time is 9 milliseconds, the PID function will execute every other sweep with an elapsed time of 18 milliseconds for every time it executes.

### 9.10.1. Parameters

Parameter	Description
enable	When enabled through a contact, the PID function is performed.
SP	SP is the control loop or process set point. Set using PV Counts, the PID adjusts the output CV so that PV matches SP (zero error).
PV	Process Variable input from the process being controlled, often a %AI input.
MAN	When energized to 1 (through a contact), the PID block is in <b>MANUAL</b> mode. If the PID block is on manual off, the PID block is in automatic mode.
UP	If energized along with MAN, it adjusts the CV up by 1 CV per solution.*
DN	If energized along with MAN, it adjusts the CV down by 1 CV per solution.*
RefArray Address	Address is the location of the PID control block information (user and internal parameters). Uses 40 %R words that cannot be shared.
ok	The ok output is energized when the function is performed without error. It is off if error(s) exist.
CV	CV is the control variable output to the process, often a %AQ analog output.

\* Incremented (UP parameter) or decremented (DN parameter) by **one** per access of the PID function.

### 9.10.2. Valid Memory Types

Parameter	flow	%I	%Q	%M	%T	%S	%G	%R	%AI	%AQ	const	none
enable	•											
SP		•	•	•	•		•	•	•	•	•	
PV		•	•	•	•		•	•	•	•		
MAN	•											
UP	•											
DN	•											
address								•				
ok	•											•
CV		•	•	•	•		•	•	•	•		

• = Valid reference or place where power may flow through the function.

### 9.10.3. PID Parameter Bloc

Besides the 2 input words and the 3 Manual control contacts, the PID block uses 13 of the parameters in the RefArray. These parameters must be set before calling the block. The other parameters are used by the PLC and are non-configurable. The %Ref shown in the table below is the same RefArray Address at the bottom of the PID block. The number after the plus sign is the offset in the array. For example, if the RefArray starts at %R100, the %R113 will contain the Manual Command used to set the Control Variable and the integrator in Manual mode.

**Table 4.4 – PID Parameters Overview**

Register	Parameter	Low Bit Units	Range of Values
%Ref+0000	Loop Number	Integer	0 to 255 (for user display only)
%Ref+0001	Algorithm	N/A; set and maintained by the PLC	Non-configurable
%Ref+0002	Sample Period	10 milliseconds	0 (every sweep) to 65535 (10.9 Min) Use at least 10 for C80–35 PLCs (see Note on § 9.10.).
%Ref+0003	Dead Band +	PV Counts	0 to 32000 (never negative)
%Ref+0004	Dead Band —	PV Counts	–32000 to 0 (never positive)
%Ref+0005	Proportional Gain –Kp	0.01 CV%/PV%	0 to 327.67 %/%
%Ref+0006	Derivative Gain–Kd	0.01 seconds	0 to 327.67 sec
%Ref+0007	Integral Rate –Ki	Repeat/1000 Sec	0 to 32.767 repeat/sec
%Ref+0008	CV Bias/Output Offset	CV Counts	–32000 to 32000 (add to integrator output)
%Ref+0009	Upper Clamp	CV Counts	–32000 to 32000(>%Ref+10) output limit
%Ref+0010	Lower Clamp	CV Counts	–32000 to 32000(<%Ref+09) output limit
%Ref+0011	Minimum Slew Time	Second/Full Travel	0 (none) to 32000 sec to move 32000 CV
%Ref+0012	Config Word	Low 5 bits used	Bit 0 to 2 for Error+/-, OutPolarity, Deriv.
%Ref+0013	Manual Command	CV Counts	Tracks CV in Auto or Sets CV in Manual
%Ref+0014	Control Word	Maintained by the PLC, <i>unless</i> Bit 1 is set.	PLC maintained unless set otherwise: low bit sets Override if 1 (see description in the “PID ParametersDetails” table on Table 4.5 )
%Ref+0015	Internal SP	N/A; set and maintained by the PLC	Non-configurable
%Ref+0016	Internal CV	N/A; set and maintained by the PLC	Non-configurable
%Ref+0017	Internal PV	N/A; set and maintained by the PLC	Non-configurable
%Ref+0018	Output	N/A; set and maintained by the PLC	Non-configurable
%Ref+0019	Diff Term Storage	N/A; set and maintained by the PLC	Non-configurable
%Ref+0020 and %Ref+0021	Int Term Storage	N/A; set and maintained by the PLC	Non-configurable
%Ref+0022	Slew Term Storage	N/A; set and maintained by the PLC	Non-configurable

Register	Parameter	Low Bit Units	Range of Values
%Ref+0023	Clock (time last executed)	N/A; set and maintained by the PLC	Non-configurable
%Ref+0024			
%Ref+0025			
%Ref+0026	Y Remainder Storage	N/A; set and maintained by the PLC	Non-configurable
%Ref+0027	Lower Range for SP, PV	PV Counts	–32000 to 32000 (>%Ref+28) for display
%Ref+0028	Upper Range for SP, PV	PV Counts	–32000 to 32000 (<%Ref+27) for display
%Ref+0029 • %Ref+0034	Reserved for internal use	N/A	Non-configurable
%Ref+0035 • %Ref+0039	Reserved for external use	N/A	Non-configurable

The RefArray array must be %R registers on the C80–35 PLC. Note that every PID block call must use a different 40-word array even if all 13 user parameters are the same because other words in the array are used for internal PID data storage. Make sure the array does not extend beyond the end of memory.

To configure the user parameters, select the PID function and press **F10** to zoom in to a screen displaying User Parameters then use arrow keys to select fields and type in desired values. You can use 0 for most default values, except the CV Upper Clamp, which must be greater than the CV Lower Clamp for the PID block to operate. Note that the PID block does **not** pass power if there is an error in User Parameters, so monitor with a temporary coil while modifying data.

Once suitable PID values have been chosen, they should be defined as constants in the BLKMOV so that they can be used to reload default PID user parameters if needed.

#### 9.10.4. Operation of the PID Instruction

Normal Automatic operation is to call the PID block every sweep with power flow to Enable and no power flow to Manual input contacts. The block compares the current PLC elapsed time clock with the last PID solution time stored in the internal RefArray. If the time difference is greater than the sample period defined in the third word (%Ref+2) of the RefArray, the PID algorithm is solved using the time difference and both the last solution time and Control Variable output are updated. In Automatic mode, the output Control Variable is placed in the Manual Command parameter %Ref+13.

If power flow is provided to both Enable and Manual input contacts, the PID block is placed in Manual mode and the output Control Variable is set from the Manual Command parameter %Ref+13. If either the UP or DN inputs have power flow, the Manual Command word is incremented or decremented by one CV count every PID solution. For faster manual changes of the output Control Variable, it is also possible to add or subtract any CV count value directly to/from the Manual Command word

The PID block uses the CV Upper and CV Lower Clamp parameters to limit the CV output. If a positive Minimum Slew Time is defined, it is used to limit the rate of change of the CV output. If either the CV amplitude or rate limit is exceeded, the value stored in the integrator is adjusted so that CV is at the limit. This anti-reset windup feature means that even if the error tried to drive CV above (or below) the clamps for a long period of time, the CV output will move off the clamp as soon as the error term changes sign.

This operation, with the Manual Command tracking CV in Automatic mode and setting CV in Manual mode, provides a bumpless transfer between Automatic and Manual modes. The CV Upper and Lower Clamps and the Minimum Slew Time still apply to the CV output in Manual mode and the internal value stored in the integrator is updated. This means that if you were to step the Manual Command in Manual mode, the CV output will not change any faster than the Minimum Slew Time (Inverse) rate limit and will not go above or below the CV Upper or CV Lower Clamp limits.

**Note**

A specific PID function should not be called more than once per sweep.

The following table provides more details about the parameters discussed briefly in Table 4.4. The number in parentheses after each parameter name is the offset in the RefArray.

**Table 4.5 – PID Parameters Details**

Data Item	Description
Loop Number (00)	This is an optional parameter available to identify a PID block. It is an unsigned integer that provides a common identification in the PLC with the loop number defined by an operator interface device. The loop number is displayed under the block address when logic is monitored from the Alspa P8–25/35/05 software.
Algorithm (01)	An unsigned integer that is set by the PLC to identify what algorithm is being used by the function block. The ISA algorithm is defined as algorithm 1, and the independent algorithm is identified as algorithm 2.
Sample Period (02)	The shortest time, in 10 millisecond increments, between solutions of the PID algorithm. For example, use a 10 for a 100 millisecond sample period. The UINT value can be up to 65535 for a sample period of 10.9 minutes. If it is 0, the algorithm is solved every time the block is called (see section below on PID block scheduling). The PID algorithm is solved only if the current PLC elapsed time clock is at or later than the last PID solution time plus this Sample Period. Remember, that the C80–35 will not use a solution time less than 10 milliseconds (see Note on § 9.10.); so sweeps will be skipped for smaller sweep times. This function compensates for the actual time elapsed since the last execution, within 100 microseconds. If this value is set to 0, the function is executed each time it is enabled however, it is restricted to a minimum of 10 milliseconds as noted above.
Dead Band (+/–) (03/04)	INT values defining the upper (+) and lower (–) Dead Band limits in PV Counts. If no Dead Band is required, these values must be 0. If the PID Error (SP – PV) or (PV – SP) is above the (–) value and below the (+) value, the PID calculations are solved with an Error of 0. If non-zero, the (+) value must be greater than 0 and the (–) value less than 0 or the PID block will not function. <i>You should leave these at 0 until the PID loop gains are setup or tuned.</i> After that, you may want to add Dead Band to avoid small CV output changes due to small variations in error, perhaps to reduce mechanical wear.

**Table 4.5 – PID Parameters Details (Continued)**

Data Item	Description
Proportional Gain–Kp (05)	This INT number, called the Controller gain, Kc, in the ISA version, determines the change in CV Counts for a 100 PV Count change in the Error term. It is displayed as 0.00 %/% with an implied decimal point of 2. For example, a Kp entered as 450 will be displayed as 4.50 and will result in a $K_p \cdot \text{Error} / 100$ or $450 \cdot \text{Error} / 100$ contribution to the PID Output. Kp is generally the first gain set when adjusting a PID loop.
Derivative Gain–Kd (06)	This INT number determines the change in CV Counts if the Error or PV changes 1 PV Count every 10 milliseconds. Entered as a time with the low bit indicating 10 milliseconds, it is displayed as 0.00 Seconds with an implied decimal point of 2. For example, a Kd entered as 120 will be displayed as 1.20 Sec and will result in a $K_d \cdot \Delta \text{Error} / \Delta \text{time}$ or $120 \cdot 4 / 3$ contribution to the PID Output if Error was changing by 4 PV Counts every 30 milliseconds. Kd can be used to speed up a slow loop response, but is very sensitive to PV input noise.
Integral Rate Gain–Ki (07)	This INT number determines the change in CV Counts if the Error were a constant 1 PV Count. It is displayed as 0.000 Repeats/Sec with an implied decimal point of 3. For example, a Ki entered as 1400 will be displayed as 1.400 Repeats/Sec and will result in a $K_i \cdot \text{Error} \cdot dt$ or $1400 \cdot 20 \cdot 50 / 1000$ contribution to PID Output for an Error of 20 PV Counts and a 50 millisecond PLC sweep time (Sample Period of 0). Ki is usually the second gain set after Kp.
CV Bias/Output Offset (08)	An INT value in CV Counts added to the PID Output before the rate and amplitude clamps. It can be used to set non-zero CV values if only Kp Proportional gains are used, or for feed forward control of this PID loop output from another control loop.
CV Upper and Lower Clamps (09/10)	INT values in CV Counts that define the highest and lowest value for CV. These values are required and the Upper Clamp must have a more positive value than the Lower Clamp, or the PID block will not work. These are usually used to define limits based on physical limits for a CV output. They are also used to scale the Bar Graph display for CV for the P8 or ADS PID display. The block has anti-reset windup to modify the integrator value when a CV clamp is reached.
Minimum Slew Time (11)	A positive UINT value to define the minimum number of seconds for the CV output to move from 0 to full travel of 100% or 32000 CV Counts. It is an inverse rate limit on how fast the CV output can be changed. If positive, CV can not change more than $32000 \text{ CV Counts} \cdot \Delta \text{Time} / \text{Minimum Slew Time}$ . For example, if the Sample Period was 2.5 seconds and the Minimum Slew Time is 500 seconds, CV can not change more than $32000 \cdot 2.5 / 500$ or 160 CV Counts per PID solution. As with the CV Clamps, there is an anti-windup feature that adjusts the integrator value if the CV rate limit is exceeded. If Minimum Slew Time is 0, there is no CV rate limit. Make sure you set Minimum Slew Time to 0 while you are tuning or adjusting PID loop gains.

**Table 4.5 – PID Parameters Details (Continued)**

<p>Config Word (12)</p>	<p>The low 4 bits of this word are used to modify three standard PID settings. The other bits should be set to 0. Set the low bit to 1 to modify the standard PID Error Term from the normal (SP – PV) to (PV – SP), reversing the sign of the feedback term. This is for Reverse Acting controls where the CV must go down when the PV goes up. Set the second bit to a 1 to invert the Output Polarity so that CV is the negative of the PID output rather than the normal positive value. Set the fourth bit to 1 to modify the Derivative Action from using the normal change in the Error term to the change in the PV feedback term.</p> <p>The low 4 bits in the Config Word are defined in detail below:</p> <p><b>Bit 0</b> = Error Term. When this bit is set to 0, the error term is <math>SP - PV</math>. When this bit is set to 1, the error term is <math>PV - SP</math>.</p> <p><b>Bit 1</b> = Output Polarity. When this bit is set to 0, the CV output represents the output of the PID calculation. When it is set to 1, the CV output represents the negative of the output of the PID calculation.</p> <p><b>Bit 2</b> = Derivative action on PV. When this bit is set to 0, the derivative action is applied to the error term. When it is set to 1, the derivative action is applied to PV. All remaining bits should be zero.</p> <p><b>Bit 3</b> = Deadband action. When the Deadband action bit is set to zero, then no deadband action is chosen. If the error is within the deadband limits, then the error is forced to be zero. Otherwise the error is not affected by the deadband limits. If the Deadband action bit is set to one, then deadband action is chosen. If the error is within the deadband limits, then the error is forced to be zero. If, however, the error is outside the deadband limits, then the error is reduced by the deadband limit (<math>error = error - deadband\ limit</math>).</p> <p><b>Bit 4</b> = Anti-resetwindup action. When this bit is set to zero, the anti-reset windup action uses a reset back calculation. When the output is clamped, this replaces the accumulated Y term with whatever value is necessary to produce the clamped output exactly. When the bit is set to one, this replaces the accumulated Y term with the value of the Y term at the start of the calculation. In this way, the pre-clamp Y value is held as long as the output is clamped.</p> <p><b>NOTE:</b> The anti-reset windup action bit is only available on release 6.50 or later C80-35 CPUs.</p> <p>Remember that the bits are set in powers of 2. For example, to set Config Word to 0 for default PID configuration, you would add 1 to change the Error Term from SP-PV to PV-SP, or add 2 to change the Output Polarity from CV = PID Output to CV = - PID Output, or add 4 to change Derivative Action from Error rate of change to PV rate of change, etc.</p>
<p>Manual Command (13)</p>	<p>This is an INT value set to the current CV output while the PID block is in Automatic mode. When the block is switched to <b>Manual</b> mode, this value is used to set the CV output and the internal value of the integrator within the Upper and Lower Clamp and Slew Time limits.</p>

**Table 4.5 – PID Parameters Details (Continued)**

Control Word (14)	<p>This is an internal parameter that is normally left at 0.</p> <p>If the Override low bit is set to 1, this word and other internal SP, PV and CV parameters must be used for remote operation of this PID block (see below). This allows remote operator interface devices, such as a computer, to take control away from the PLC program. Caution: if you do not want this to happen, make use the Control Word is set to 0. If the low bit is 0, the next 4 bits can be read to track the status of the PID input contacts as long as the PID Enable contact has power. A discrete data structure with the first five bit positions in the following format:</p> <table border="1"> <thead> <tr> <th>Bit:</th> <th>Word Value:</th> <th>Function:</th> <th>Status or External Action if Override bit set to 1:</th> </tr> </thead> <tbody> <tr> <td>0</td> <td>1</td> <td>Override</td> <td>If 0, monitor block contacts below. If 1, set them externally.</td> </tr> <tr> <td>1</td> <td>2</td> <td>Manual/ Auto</td> <td>If 1, block is in <b>Manual</b> mode; other numbers it is in <b>Automatic</b> mode.</td> </tr> <tr> <td>2</td> <td>4</td> <td>Enable</td> <td>Should normally be 1; otherwise block is never called.</td> </tr> <tr> <td>3</td> <td>8</td> <td>UP/Raise</td> <td>If 1 and Manual (Bit 1) is 1, CV is being incremented every solution.</td> </tr> <tr> <td>4</td> <td>16</td> <td>DN/Lower</td> <td>If 1 and Manual (Bit 1) is 1, CV is being incremented every solution.</td> </tr> </tbody> </table>	Bit:	Word Value:	Function:	Status or External Action if Override bit set to 1:	0	1	Override	If 0, monitor block contacts below. If 1, set them externally.	1	2	Manual/ Auto	If 1, block is in <b>Manual</b> mode; other numbers it is in <b>Automatic</b> mode.	2	4	Enable	Should normally be 1; otherwise block is never called.	3	8	UP/Raise	If 1 and Manual (Bit 1) is 1, CV is being incremented every solution.	4	16	DN/Lower	If 1 and Manual (Bit 1) is 1, CV is being incremented every solution.
Bit:	Word Value:	Function:	Status or External Action if Override bit set to 1:																						
0	1	Override	If 0, monitor block contacts below. If 1, set them externally.																						
1	2	Manual/ Auto	If 1, block is in <b>Manual</b> mode; other numbers it is in <b>Automatic</b> mode.																						
2	4	Enable	Should normally be 1; otherwise block is never called.																						
3	8	UP/Raise	If 1 and Manual (Bit 1) is 1, CV is being incremented every solution.																						
4	16	DN/Lower	If 1 and Manual (Bit 1) is 1, CV is being incremented every solution.																						
SP (15)	(Non-configurable–set and maintained by the PLC) Tracks SP in; must be set externally if Override = 1.																								
CV (16)	(Non-configurable–set and maintained by the PLC) Tracks CV out.																								
PV (17)	(Non-configurable–set and maintained by the PLC) Tracks PV in; must be set externally if Override bit = 1.																								
Output (18)	(Non-configurable–set and maintained by the PLC) This is a signed word value representing the output of the function block before the application of the optional inversion. If no output inversion is configured and the output polarity bit in the control word is set to 0, this value will equal the CV output. If inversion is selected and the output polarity bit is set to 1, this value will equal the negative of the CV output.																								
Diff Term Storage (19)	Used internally for storage of intermediate values. <i>Do not write to this location.</i>																								
Int Term Storage (20/21)	Used internally for storage of intermediate values. <i>Do not write to this location.</i>																								
Slew Term Storage (22)	Used internally for storage of intermediate values. <i>Do not write to this location.</i>																								
Clock (23–25)	Internal elapsed time storage (time last PID executed). <i>Do not write to these locations.</i>																								
Y Remainder (26)	Holds remainder for integrator division scaling for 0 steady state error.																								
Lower and Upper Range (27/28)	Optional INT values in PV Counts that define the highest and lowest display value for the SP and PV Logicmaster <b>zoom</b> key horizontal bar graph and ADS PID faceplate display.																								
Reserved (29–34 and 35–39)	29–34 are reserved for internal use; 35–39 are reserved for external use. They are reserved for Cegelec use, and cannot be used for other purposes.																								

### 9.10.5. Internal Parameters in RefArray

As described in Table 4.5 on the previous pages, the PID block reads 13 user parameters and uses the rest of the 40 word RefArray for internal PID storage. Normally you would not need to change any of these values. If you are calling the PID block in Auto mode after a long delay, you may want to use SVC\_REQ 16 to load the current PLC elapsed time clock into %Ref+23 to update the last PID solution time to avoid a step change on the integrator. If you have set the Override low bit of the Control Word (%Ref+14) to 1, the next four bits of the Control Word must be set to control the PID block input contacts (as described in Table 4.5 on the previous pages), and the Internal SP and PV must be set as you have taken control of the PID block away from the ladder logic. The internal parameter words are:

### 9.10.6. PID Algorithm Selection (PIDISA or PIDIND) and Gains

The PID block can be programmed selecting either the Independent (PID\_IND) term or standard ISA (PID\_ISA) versions of the PID algorithm. The only difference in the algorithms is how the Integral and Derivative gains are defined. To understand the difference, you need to understand the following:

Both PID types calculate the Error term as  $SP - PV$ , which can be changed to Reverse Acting mode  $PV - SP$  if the Error Term (low bit 0 in the Config Word %Ref+12) is set to 1. Reverse Acting mode may be used if you want the CV output to move in the opposite direction from PV input changes (CV down for PV up) rather than the normal CV up for PV up.

$$\text{Error} = (SP - PV) \quad \text{or } (PV - SP) \text{ if low bit of Config Word set to 1}$$

The Derivative is normally based on the change of the Error term since the last PID solution, which may cause a large change in the output if the SP value is changed. If this is not desired, the third bit of the Config Word can be set to 1 to calculate the Derivative based on the change of the PV. The dt (or Delta Time) is determined by subtracting the last PID solution clock time for this block from the current PLC elapsed time clock.

$$dt = \text{Current PLC Elapsed Time clock} - \text{PLC Elapsed Time Clock at Last PID solution}$$

$$\text{Derivative} = (\text{Error} - \text{previous Error})/dt \quad \text{or } (PV - \text{previous PV})/dt \text{ if 3rd bit of Config Word set to 1}$$

The Independent term PID (PID\_IND) algorithm calculates the output as:

$$\text{PID Output} = K_p * \text{Error} + K_i * \text{Error} * dt + K_d * \text{Derivative} + \text{CV Bias}$$

The standard ISA (PID\_ISA) algorithm has a different form:

$$\text{PID Output} = K_c * (\text{Error} + \text{Error} * dt/T_i + T_d * \text{Derivative}) + \text{CV Bias}$$

where  $K_c$  is the controller gain, and  $T_i$  is the Integral time and  $T_d$  is the Derivative time. The advantage of ISA is that adjusting the  $K_c$  changes the contribution for the integral and derivative terms as well as the proportional one, which may make loop tuning easier. If you have PID gains in terms of  $T_i$  and  $T_d$ , use

$$K_p = K_c \quad K_i = K_c/T_i \quad \text{and} \quad K_d = K_c/T_d$$

to convert them to use as PID User Parameter inputs.

The CV Bias term above is an additive term separate from the PID components. It may be required if you are using only Proportional Kp gain and you want the CV to be a non-zero value when the PV equals the SP and the Error is 0. In this case, set the CV Bias to the desired CV when the PV is at the SP. CV Bias can also be used for feed forward control where another PID loop or control algorithm is used to adjust the CV output of this PID loop.

If an Integral Ki gain is used, the CV Bias would normally be 0 as the integrator acts as an automatic bias. Just start up in Manual mode and use the Manual Command word (%Ref+13) to set the integrator to the desired CV, then switch to Automatic mode. This also works if Ki is 0, except the integrator will not be adjusted based on the Error after going into Automatic mode.

The following diagram shows how the PID algorithms work:

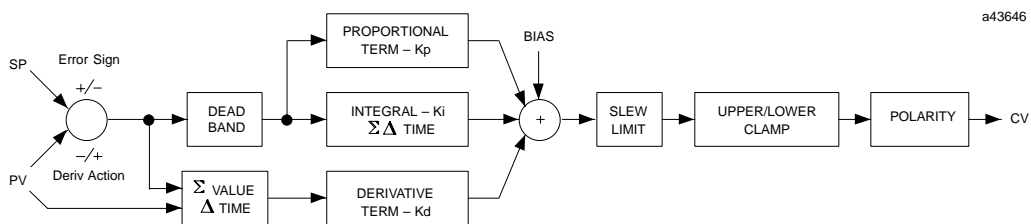

**Figure 4.1 – Independent Term Algorithm (PIDIND)**

The ISA Algorithm (PIDISA) is similar except the Kp gain is factored out of Ki and Kd so that the integral gain is Kp \* Ki and derivative gain is Kp \* Kd. The Error sign, DerivAction and Polarity are set by bits in the Config Word user parameter.

### 9.10.7. CV Amplitude and Rate Limits

The block does not send the calculated PID Output directly to CV. Both PID algorithms can impose amplitude and rate of change limits on the output Control Variable. The maximum rate of change is determined by dividing the maximum 100% CV value (32000) by the Minimum Slew Time, if specified as greater than 0. For example, if the Minimum Slew Time is 100 seconds, the rate limit will be 320 CV counts per second. If the dt solution time was 50 milliseconds, the new CV output can not change more than 320\*50/1000 or 16 CV counts from the previous CV output.

The CV output is then compared to the CV Upper and CV Lower Clamp values. If either limit is exceeded, the CV output is set to the clamped value. If either rate or amplitude limits are exceeded modifying CV, the internal integrator value is adjusted to match the limited value to avoid reset windup.

Finally, the block checks the Output Polarity (2nd bit of the Config Word %Ref+12) and changes the sign of the output if the bit is 1.

$$CV = \text{Clamped PID Output} \quad \text{or} \quad - \text{Clamped PID Output if Output Polarity bit set}$$

If the block is in Automatic mode, the final CV is placed in the Manual Command %Ref+13. If the block is in Manual mode, the PID equation is skipped as CV is set by the Manual Command, but all the rate and amplitude limits are still checked. That means that the Manual Command can not change the output above the CV Upper Clamp or below the CV Lower Clamps and the output can not change faster than the Minimum Slew Time allowed.

### 9.10.8. Sample Period and PID Block Scheduling

The PID block is a digital implementation of an analog control function, so the dt sample time in the PID Output equation is not the infinitesimally small sample time available with analog controls. The majority of processes being controlled can be approximated as a gain with a first or second order lag, possibly with a pure time delay. The PID block sets a CV output to the process and uses the process feedback PV to determine an Error to adjust the next CV output. A key process parameter is the total time constant, which is how fast does the PV respond when the CV is changed. As discussed in the Setting Loop Gains section below, the total time constant,  $T_p+T_c$ , for a first order system is the time required for PV to reach 63% of its final value when CV is stepped. The PID block will not be able to control a process unless its Sample Period is well under half the total time constant. Larger Sample Periods will make it unstable.

The Sample Period should be no bigger than the total time constant divided by 10 (or down to 5 worst case). For example, if PV seems to reach about 2/3 of its final value in 2 seconds the Sample Period should be less than 0.2 seconds or 0.4 seconds worst case. On the other hand, the Sample Period should not be too small, such as less than the total time constant divided by 1000 or the  $K_i * Error * dt$  term for the PID integrator will round down to 0. For example, a very slow process that takes 10 hours or 36000 seconds to reach the 63% level should have a Sample Period of 40 seconds or longer.

Unless the process is very fast, it is not usually necessary to use a Sample Period of 0 to solve the PID algorithm every PID sweep. If many PID loops are used with a Sample Period greater than the sweep time, there may be wide variations in PLC sweep time if many loops end up solving the algorithm at the same time. The simple solution is to sequence a one or more 1 bits through an array of bits set to 0 that is being used to enable power flow to individual PID blocks.

### 9.10.9. Determining the Process Characteristics

The PID loop gains,  $K_p$ ,  $K_i$  and  $K_d$ , are determined by the characteristics of the process being controlled. Two key questions when setting up a PID loop are:

1. How big is the change in PV when we change CV by a fixed amount or what is the open loop gain?
2. How fast does the system respond or how quick does PV change after the CV output is stepped?

Many processes can be approximated by a process gain, first or second order lag and a pure time delay. In the frequency domain, the transfer function for a first order lag system with a pure time delay is:

$$PV(s)/CV(s) = G(s) = K * e^{**(-T_p s)} / (1 + T_c s)$$

Plotting a step response at time  $t_0$  in the time domain provides an open loop unit reaction curve:

CV Unit Step Output to Process

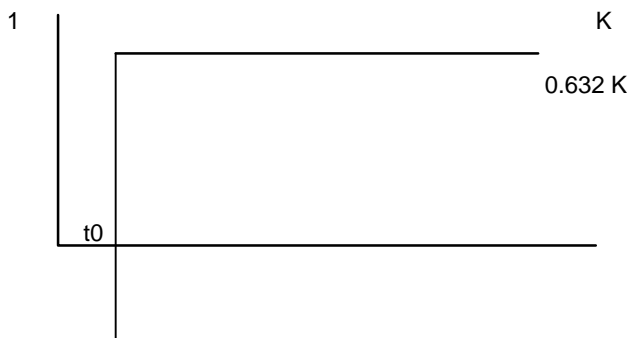

PV Unit Reaction Curve Input from Process

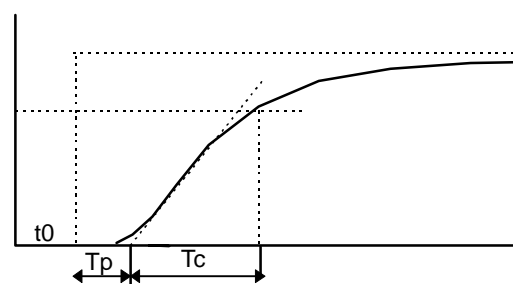

The following process model parameters can be determined from the PV unit reaction curve:

K	Process open loop gain = final change in PV/change in CV at time t0 (Note no subscript on K)
Tp	Process or pipeline time delay or dead time after t0 before the process output PV starts moving
Tc	First order Process time constant, time required after Tp for PV to reach 63.2% of the final PV

Usually the quickest way to measure these parameters is by putting the PID block in Manual mode and making a small step in CV output, by changing the Manual Command %Ref+13 and plotting the PV response over time. For slow processes, this can be done manually, but for faster processes a chart recorder or computer graphic data logging package will help. The CV step size should be large enough to cause an observable change in PV, but not so large that it disrupts the process being measured. A good size may be from 2 to 10% of the difference between the CV Upper and CV Lower Clamp values .

### 9.10.10. Setting User Parameters Including Tuning Loop Gains

As all PID parameters are totally dependent on the process being controlled, there are no predetermined values that will work, however, it is usually a simple, iterative procedure to find acceptable loop gain..

1. Set all the User Parameters to 0, then set the CV Upper and CV Lower Clamps to the highest and lowest CV expected. Set the Sample Period to the estimated process time constant(above)/10 to 100.
2. Put block in Manual mode and set Manual Command (%Ref+13) at different values to check if CV can be moved to Upper and Lower Clamp. Record PV value at some CV point and load it into SP.
3. Set a small gain, such as 100 \* Maximum CV/Maximum PV, into Kp and turn off Manual mode. Step SP by 2 to 10% of the Maximum PV range and observe PV response. Increase Kp if PV step response is too slow or reduce Kp if PV overshoots and oscillates without reaching a steady value.
4. Once a Kp is found, start increasing Ki to get overshooting that dampens out to a steady value in 2 to 3 cycles. This may required reducing Kp. Also try different step sizes and CV operating points.
5. After suitable Kp and Ki gains are found, try adding Kd to get quicker responses to input changes providing it doesn't cause oscillations. Kd is often not needed and will not work with noisy PV.
6. Check gains over different SP operating points and add Dead Band and Minimum Slew Time if needed. Some Reverse Acting processes may need setting Config Word Error Sign or Polarity bits

### 9.10.11. Setting Loop Gains—Ziegler and Nichols Tuning Approach

Once the three process model parameters, K, Tp and Tc, are determined, they can be used to estimate initial PID loop gains. The following approach, developed by Ziegler and Nichols in the 1940's, is designed to provide good response to system disturbances with gains producing a amplitude ratio of 1/4. The amplitude ratio is the ratio of the second peak over the first peak in the closed loop response.

1. Calculate the Reaction rate:

$$R = K/Tc$$

2. For Proportional control only, calculate Kp as:

$$Kp = 1/(R * Tp) = Tc/(K * Tp)$$

3. For Proportional and Integral control, use:

$$Kp = 0.9/(R * Tp) = 0.9 * Tc/(K * Tp)$$

$$Ki = 0.3 * Kp/Tp$$

4. For Proportional, Integral and Derivative control, use:

$$Kp = G/(R * Tp) \text{ where } G \text{ is from } 1.2 \text{ to } 2.0$$

$$Ki = 0.5 * Kp/Tp$$

$$Kd = 0.5 * Kp * Tp$$

5. Check that the Sample Period is in the range  $(Tp + Tc)/10$  to  $(Tp + Tc)/1000$ .

Another approach, the "Ideal Tuning" procedure, is designed to provide the best response to SP changes, delayed only by the Tp process delay or dead time.

$$Kp = 2 * Tc/(3 * K * Tp)$$

$$Ki = Tc$$

$$Kd = Ki/4 \quad \text{if Derivative term is used}$$

Once initial gains are determined, they must be converted to integer User Parameters. To avoid scaling problems, the Process gain, K, should be calculated as a change in input PV Counts divided by the output step change in CV Counts and not in process PV or CV engineering units. All times should also be specified in seconds. Once Kp, Ki and Kd are determined, Kp and Kd can be multiplied by 100 and entered as integer while Ki can be multiplied by 1000 and entered into the User Parameter %RefArray.



The block can be switched to Manual mode with %M1 so that the Manual Command, %R113, can be adjusted. Bits %M4 or %M5 can be used to increase or decrease %R113 and the PID CV and integrator by 1 every 100 MSec solution. For faster manual operation, bits %M2 and %M3 can be used to add or subtract the value in %R2 to/from %R113 every PLC sweep. The %T1 output is on when the PID is OK.



# Appendix *Instruction Timing*

## A

The Alspa C80–35, C80–25 and C80–05 PLCs support many different functions and function blocks. This appendix contains tables showing the memory size in bytes and the execution time in microseconds for each function. Memory size is the number of bytes required by the function in a ladder diagram application program.

Two execution times are shown for each function:

<b>Execution Time</b>	<b>Description</b>
Enabled	Time required to execute the function or function block when power flows into and out of the function. Typically, best–case times are when the data used by the block is contained in user RAM (word–oriented memory) and not in the the ISCP cache memory (discrete memory).
Disabled	Time required to execute the function when power flows into the function or function block; however, it is in an inactive state, as when a timer is held in the reset state.

### Note

Timers and counters are updated each time they are encountered in the logic, timers by the amount of time consumed by the last sweep and counters by one count.

**Table A.1 – Instruction Timing**

Function Group	Function	Enabled				Disabled				Increment				Size
		311	313	331	341	311	313	331	341	311	313	331	341	
Timers	On-Delay Timer	146	81	101	42	105	39	46	21	–	–	–	–	15
	Off-Delay Timer	98	47	54	23	116	63	73	32	–	–	–	–	9
	Timer	122	76	95	40	103	54	66	30	–	–	–	–	15
Counters	Up Counter	137	70	87	36	130	63	78	33	–	–	–	–	11
	Down Counter	136	70	86	37	127	61	75	31	–	–	–	–	11
Math	Addition (INT)	76	47	56	24	41	0	0	0	–	–	–	–	13
	Addition (DINT)	90	60	76	34	41	1	0	0	–	–	–	–	13
	Subtraction (INT)	75	46	57	25	41	0	0	0	–	–	–	–	13
	Subtraction (DINT)	92	62	78	34	41	1	0	0	–	–	–	–	13
	Multiplication (INT)	79	49	62	28	41	0	0	0	–	–	–	–	13
	Multiplication (DINT)	108	80	100	43	41	1	0	0	–	–	–	–	13
	Division (INT)	79	51	61	27	41	0	0	0	–	–	–	–	13
	Division (DINT)	375	346	434	175	41	1	0	0	–	–	–	–	13
	Modulo Division (INT)	78	51	61	27	41	0	0	0	–	–	–	–	13
	Modulo Div (DINT)	134	103	130	54	41	1	0	0	–	–	–	–	13
	Square Root (INT)	153	124	155	65	42	0	0	0	–	–	–	–	9
Square Root (DINT)	268	239	299	120	42	0	1	1	–	–	–	–	9	
Relational	Equal (INT)	66	35	44	19	41	1	1	0	–	–	–	–	9
	Equal (DINT)	86	56	68	29	41	1	1	0	–	–	–	–	9
	Not Equal (INT)	67	39	48	22	41	1	1	0	–	–	–	–	9
	Not Equal (DINT)	81	51	65	28	41	1	1	0	–	–	–	–	9
	Greater Than (INT)	64	33	42	20	41	1	1	0	–	–	–	–	9
	Greater Than (DINT)	89	59	73	32	41	1	1	0	–	–	–	–	9
	Greater Than/Eq (INT)	64	36	42	19	41	1	1	0	–	–	–	–	9
	Greater Than/Eq (DINT)	87	58	73	30	41	1	1	0	–	–	–	–	9
	Less Than (INT)	66	35	44	19	41	1	1	0	–	–	–	–	9
	Less Than (DINT)	87	57	70	30	41	1	1	0	–	–	–	–	9
	Less Than/Equal (INT)	66	36	44	21	41	1	1	0	–	–	–	–	9
	Less Than/Equal (DINT)	86	57	70	31	41	1	1	0	–	–	–	–	9
	Range (INT)	92	58	66	29	46	1	0	1	–	–	–	–	15
	Range(DINT)	106	75	84	37	45	0	0	0	–	–	–	–	15
	Range(WORD)	93	60	67	29	0	0	0	0	–	–	–	–	15
Bit Operation	Logical AND	67	37	48	22	42	0	0	1	–	–	–	–	13
	Logical OR	68	38	48	21	42	0	0	1	–	–	–	–	13
	Logical Exclusive OR	66	38	47	20	42	0	0	1	–	–	–	–	13
	Logical Invert, NOT	62	32	40	17	42	0	0	1	–	–	–	–	9
	Shift Bit Left	139	89	111	47	74	26	30	13	11.61	11.61	15.05	6.29	15
	Shift Bit Right	135	87	107	45	75	26	30	13	11.63	11.62	15.07	6.33	15
	Rotate Bit Left	156	127	158	65	42	1	0	0	11.70	11.78	15.18	6.33	15
	Rotate Bit Right	146	116	147	62	42	1	0	0	11.74	11.74	15.23	6.27	15
	Bit Position	102	72	126	38	42	1	153	0	–	–	–	–	13
	Bit Clear	68	38	34	21	42	1	33	1	–	–	–	–	13
	Bit Test	79	49	132	28	41	0	126	1	–	–	–	–	13
	Bit Set	67	37	0	20	42	0	36	0	–	–	–	–	13
	Masked Compare (WORD)	217	154	177	74	107	44	50	21	–	–	–	–	25
	Masked Compare (DWORD)	232	169	195	83	108	44	49	22	–	–	–	–	25

**Table A.1 – Instruction Timing – Continued**

Function Group	Function	Enabled				Disabled				Increment				Size
		311	313	331	341	311	313	331	341	311	313	331	341	
Data Move	Move (INT)	68	37	49	20	43	0	1	0	1.62	1.62	6.60	1.31	13
	Move (BIT)	94	62	77	35	42	0	0	0	12.61	12.64	15.78	6.33	13
	Move (WORD)	67	37	49	20	41	0	1	0	1.62	1.63	6.60	1.31	13
	Block Move (INT)	76	48	61	28	59	30	34	16	–	–	–	–	27
	Block Move (WORD)	76	48	62	29	59	29	35	15	–	–	–	–	27
	Block Clear	56	28	33	14	43	0	0	0	1.35	1.29	1.78	0.78	9
	Shift Register (BIT)	201	153	192	79	85	36	43	18	0.69	0.68	0.88	0.37	15
	Shift Register (WORD)	103	53	67	29	73	25	29	12	1.62	1.62	2.54	1.31	15
	Bit Sequencer	165	101	127	53	96	31	37	16	0.07	0.07	0.10	0.05	15
	COMM_REQ	1317	1272	1577	884	41	2	0	0	–	–	–	–	13
Table	Array Move													
	INT	230	201	254	104	72	41	49	20	1.29	1.15	7.16	2.06	21
	DINT	231	202	260	105	74	44	53	23	3.24	3.24	13.20	2.61	21
	BIT	290	261	329	135	74	43	51	23	0.03	0.03	0.39	0.79	21
	BYTE	228	198	252	104	74	42	51	23	0.81	0.82	5.58	1.25	21
	WORD	230	201	254	104	72	41	49	20	1.29	1.15	7.16	2.06	21
	Search Equal													
	INT	197	158	199	82	78	39	46	20	1.93	1.97	3.17	1.55	19
	DINT	206	166	209	87	79	38	47	21	4.33	4.34	5.72	2.44	19
	BYTE	179	141	177	74	78	38	45	21	1.53	1.49	2.29	1.03	19
	WORD	197	158	199	82	78	39	46	20	1.93	1.97	3.17	1.55	19
	Search Not Equal													
	INT	198	159	200	83	79	39	46	21	1.93	1.93	3.17	1.52	19
	DINT	201	163	204	84	79	37	46	21	6.49	6.47	8.63	3.82	19
	BYTE	179	141	178	73	79	38	47	19	1.54	1.51	2.29	1.05	19
	WORD	198	159	200	83	79	39	46	21	1.93	1.93	3.17	1.52	19
	Search Greater Than													
	INT	198	160	200	82	79	37	47	19	3.83	3.83	5.62	2.59	19
	DINT	206	167	210	88	78	38	46	20	8.61	8.61	11.29	4.88	19
	BYTE	181	143	178	73	79	37	45	19	3.44	3.44	4.69	2.03	19
	WORD	198	160	200	82	79	37	47	19	3.83	3.83	5.62	2.59	19
	Search Greater Than/Eq													
	INT	197	160	200	83	77	38	46	20	3.86	3.83	5.62	2.52	19
	DINT	205	167	210	87	80	39	46	21	8.62	8.61	11.30	4.87	19
	BYTE	180	142	178	75	79	37	46	20	3.47	3.44	4.69	2.00	19
	WORD	197	160	200	83	77	38	46	20	3.86	3.83	5.62	2.52	19
	Search Less Than													
	INT	199	159	201	84	78	38	46	20	3.83	3.86	5.59	2.48	19
DINT	206	168	210	87	79	38	45	19	8.62	8.60	11.29	4.88	19	
BYTE	181	143	178	75	80	38	46	20	3.44	3.44	4.69	2.00	19	
WORD	199	159	201	84	78	38	46	20	3.83	3.86	5.55	2.48	19	
Search Less Than/Equal														
INT	200	158	200	82	79	38	46	21	3.79	3.90	5.59	2.55	19	
DINT	207	167	209	88	78	39	46	19	8.60	8.61	11.30	4.86	19	
BYTE	180	143	178	74	78	40	46	19	3.46	3.44	4.69	2.02	19	
WORD	200	158	200	82	79	38	46	21	3.79	3.90	5.59	2.55	19	
Conversion	Convert to INT	74	46	57	25	42	1	0	1	–	–	–	–	9
	Convert to BCD–4	77	50	60	25	42	1	0	1	–	–	–	–	9

**Table A.1 – Instruction Timing – Continued**

Function Group	Function	Enabled				Disabled				Increment				Size
		311	313	331	341	311	313	331	341	311	313	331	341	
Control	Call a Subroutine	155	93	116	85	41	0	0	0	–	–	–	–	7
	Do I/O	309	278	355	177	38	1	0	0	–	–	–	–	12
	PID – ISA Algorithm	1870	1827	2311	929	91	56	71	30	–	–	–	–	15
	PID – IND Algorithm	2047	2007	2529	1017	91	56	71	30	–	–	–	–	15
	End Instruction	–	–	–	–	–	–	–	–	–	–	–	–	–
	Service Request													
	6	93	54	68	45	41	2	0	0	–	–	–	–	9
	7 (Read)	–	37	363	161	–	2	0	0	–	–	–	–	9
	7 (Set)	–	37	363	161	–	2	0	0	–	–	–	–	9
	14	447	418	599	244	41	2	0	0	–	–	–	–	9
	15	281	243	305	139	41	2	0	0	–	–	–	–	9
	16	131	104	131	69	41	2	0	0	–	–	–	–	9
	18	–	56	365	180	–	2	0	0	–	–	–	–	9
	23	1689	1663	2110	939	43	1	0	0	–	–	–	–	9
	26//30*	1268	1354	8774	3538	42	0	0	0	–	–	–	–	9
	29	–	–	58	41	–	–	1	0	–	–	–	–	9
	Nested MCR/ENDMCR Combined	135	73	88	39	75	25	28	12	–	–	–	–	8

**Table A.1 – Instruction Timing – Continued**

Function Group	Function	Enabled	Disabled	Increment	Size
		351/352	351/352	351/352	
Timers	On-Delay Timer	4	4	–	15
	Timer	2	3	–	15
	Off-Delay Timer	2	2	–	15
Counters	Up Counter	2	2	–	13
	Down Counter	2	2	–	13
Math	Addition (INT)	1	0	–	13
	Addition (DINT)	2	0	–	19
	Addition (REAL), 352 only	33	0	–	17
	Subtraction (INT)	1	0	–	13
	Subtraction (DINT)	2	0	–	19
	Subtraction (REAL), 352 only	34	0	–	17
	Multiplication (INT)	21	0	–	13
	Multiplication (DINT)	24	0	–	19
	Multiplication (REAL), 352 only	38	1	–	17
	Division (INT)	22	0	–	13
	Division (DINT)	25	0	–	19
	Division (REAL), 352 only	36	2	–	17
	Modulo Division (INT)	21	0	–	13
	Modulo Div (DINT)	25	0	–	19
	Square Root (INT)	41	1	–	10
	Square Root (DINT)	76	0	–	13
Square Root (REAL), 352 only	35	0	–	11	
Trigonometric	SIN (REAL), 352 only	32	0	–	11
	COS (REAL), 352 only	29	0	–	11
	TAN (REAL), 352 only	32	1	–	11
	ASIN (REAL), 352 only	45	0	–	11
	ACOS (REAL), 352 only	63	0	–	11
	ATAN (REAL), 352 only	33	1	–	11
Logarithmic	LOG (REAL), 352 only	32	0	–	11
	LN (REAL), 352 only	32	0	–	11
Exponential	EXP, 352 only	42	0	–	11
	EXPT, 352 only	54	1	–	17
Radian Conversion	Convert RAD to DEG, 352 only	32	1	–	11
	Convert DEG to RAD, 352 only	32	0	–	11

**Table A.1 – Instruction Timing – Continued**

Function Group	Function	Enabled	Disabled	Increment	Size
		351/352	351/352	351/352	
Relational	Equal (INT)	1	0	–	10
	Equal (DINT)	2	0	–	16
	Equal (REAL), 352 only	33	0	–	14
	Not Equal (INT)	1	0	–	10
	Not Equal (DINT)	1	0	–	16
	Not Equal (REAL), 352 only	31	0	–	14
	Greater Than (INT)	1	0	–	10
	Greater Than (DINT)	1	0	–	16
	Greater Than (REAL), 352 only	32	0	–	14
	Greater Than/Equal (INT)	1	0	–	10
	Greater Than/Equal (DINT)	1	0	–	10
	Greater Than/Equal (REAL), 352 only	36	1	–	14
	Less Than (INT)	1	0	–	10
	Less Than (DINT)	1	0	–	16
	Less Than (REAL), 352 only	36	1	–	14
	Less Than/Equal (INT)	1	0	–	10
	Less Than/Equal (DINT)	3	0	–	16
	Less Than/Equal (REAL), 352 only	37	0	–	14
	Range (INT)	2	1	–	13
	Range (DINT)	2	1	–	22
Range (WORD)	1	0	–	13	
Bit Operation	Logical AND	2	0	–	13
	Logical OR	2	0	–	13
	Logical Exclusive OR	1	0	–	13
	Logical Invert, NOT	1	0	–	10
	Shift Bit Left	31	1	1.37	16
	Shift Bit Right	28	0	3.03	16
	Rotate Bit Left	25	0	3.12	16
	Rotate Bit Right	25	0	4.14	16
	Bit Position	20	1	–	13
	Bit Clear	20	0	–	13
	Bit Test	20	0	–	13
	Bit Set	19	1	–	13
	Mask Compare (WORD)	46	0	–	25
	Mask Compare (DWORD)	48	0	–	25

**Table A.1 – Instruction Timing – Continued**

Function Group	Function	Enabled	Disabled	Increment	Size
		351/352	351/352	351/352	
Data Move	Move (INT)	0	0	0.41	10
	Move (BIT)	28	0	4.98	13
	Move (WORD)	1	1	0.41	10
	Move (REAL), 352 only	24	1	0.82	13
	Block Move (INT)	3	0	–	28
	Block Move (WORD)	3	0	–	28
	Block Move (REAL)	36	0	–	13
	Block Clear	1	0	0.24	11
	Shift Register (BIT)	46	0	0.23	16
	Shift Register (WORD)	27	0	0.41	16
	Bit Sequencer	38	22	0.02	16
Table	Array Move				
	INT	54	0	0.97	22
	DINT	54	0	0.81	22
	BIT	69	0	0.36	22
	BYTE	54	1	0.64	22
	WORD	54	0	0.97	22
	Search Equal				
	INT	37	0	0.62	19
	DINT	41	1	1.38	22
	BYTE	35	0	0.46	19
	WORD	37	0	0.62	19
	Search Not Equal				
	INT	37	0	0.62	19
	DINT	38	0	2.14	22
	BYTE	37	0	0.47	19
	WORD	37	0	0.62	19
	Search Greater Than				
	INT	37	0	1.52	19
	DINT	39	0	2.26	22
	BYTE	36	1	1.24	19
	WORD	37	0	1.52	19
	Search Greater Than/Equal				
	INT	37	0	1.48	19
	DINT	39	0	2.33	22
	BYTE	37	1	1.34	19
	WORD	37	0	1.48	19
	Search Less Than				
	INT	37	0	1.52	19
	DINT	41	1	2.27	22
	BYTE	37	0	1.41	19
	WORD	37	0	1.52	19
	Search Less Than/Equal				
INT	38	0	1.48	19	
DINT	40	1	2.30	22	
BYTE	37	0	1.24	19	
WORD	38	0	1.48	19	
Conversion	Convert to INT	19	1	–	10
	Convert to BCD-4	21	1	–	10
	Convert to REAL, 352 only	21	0	–	8
	Convert to WORD, 352 only	30	1	–	11
	Truncate to INT, 352 only	32	0	–	11
	Truncate to DINT, 352 only	31	0	–	11

**Table A.1 – Instruction Timing – Continued**

Function Group	Function	Enabled	Disabled	Increment	Size
		351/352	351/352	351/352	
Control	Call a Subroutine	40	1	–	7
	Do I/O	123	1	–	13
	PID – ISA Algorithm*	162	34	–	16
	PID – IND Algorithm*	146	34	–	16
	End Instruction	–	–	–	–
	Service Request				
	#6	22	1	–	10
	#7 (Read)	75	1	–	10
	#7 (Set)	75	1	–	10
	#14	121	1	–	10
	#15	46	1	–	10
	#16	36	1	–	10
	#18	261	1	–	10
	#23	426	0	–	10
	#26//30**	2910	1	–	10
	#29	20	0	–	10
	Nested MCR/ENDMCR Combined	1	1	–	4
COMM_REQ	732	0	–	13	

\*The PID times shown above are based on the 6.5 release of the 351 CPU.

\*\*Service request 26/30 was measured using a high speed counter, 16-point output, in a 5-slot rack.

- Notes:**
1. Time (in microseconds) is based on Release 7 of Alspa P8–25/35/05 software for Model 351 CPUs.
  2. For table functions, increment is in units of length specified.; for bit operation functions, microseconds/bit.; for data move functions, microseconds/number of bits or words.
  3. Enabled time for single length units of type %R, %AI, and %AW.
  4. COMMREQ time has been measured between CPU and HSC.
  5. DOIO is the time to output values to discrete output module.
  6. Where there is more than one possible case, the time indicated above represents the worst possible case.

**Timing information for the Micro PLC:** See the *ALS 52119 Alspa C80–05 Micro PLC User’s Manual* for this information. In the next release of this manual, these figures will be presented here.

Timing information for the 351/352 PLC. See page A–5 and following.

**Instruction Sizes for 351 and 352 CPUs**

Memory size is the number of bytes required by the instruction in a ladder diagram application program. Model 351 and 352 CPUs require three (3) bytes for most standard boolean functions—see Table A.2.

**Table A.2 – Instruction Sizes for 351 and 352 CPUs**

Function	Size
No operation	1
Pop stack and AND to top	1
Pop stack and OR to top	1
Duplicate top of stack	1
Pop stack	1
Initial stack	1
Label	5
Jump	5
All other instructions	3
Function blocks—see Table A.1	–

# Appendix B

## Interpreting Faults Using Alspa P8-25/35/05 Software

The Alspa C80-35, C80-25 and C80-05 PLCs maintain two fault tables, the I/O fault table for faults generated by I/O devices (including I/O controllers) and the PLC fault table for internal PLC faults. The information in this appendix will enable you to interpret the message structure format when reading these fault tables.

This is a sample I/O fault table, as it is displayed in Alspa P8-25/35/05 configuration software.

```

|PROGRAM |TABLES |STATUS |      |      |      |SETUP |FOLDER |UTILITY |PRINT
|1plcrun |2passwd |3plcflt |4io flt |5plcmem |6blkmem |7refsiz |8sweep |9clear |10zoom
>
I / O  F A U L T  T A B L E

TOP FAULT DISPLAYED: 0000Z          TABLE LAST CLEARED: 01-21 08:26:37
TOTAL FAULTS: 0000Z              ENTRIES OVERFLOWED: 00000
FAULT DESCRIPTION:                PLC DATE/TIME: 01-22 05:54:48

  FAULT   CIRC REFERENCE   FAULT   FAULT   DATE   TIME
  LOCATION NO.   ADDR.   CATEGORY TYPE   M-D   H: M: S
-----
0.3                ADD'N OF I/O MODULE          01-22 05:54:13
0.3                ADD'N OF I/O MODULE          01-22 05:54:02

ID:          STOP/NO IO          ONLINE  L4 ACC: WRITE LOGIC  CONFIG EQUAL
C:\P8\LESSON          PRG: LESSON
REPLACE

```

This is a sample PLC fault table, as it is displayed in Alspa P8–25/35/05 programming software.

I/O	CPU	STATUS			SETUP	FOLDER	UTILITY	PRINT	
1 plcrun	2 passwd	3 plcflt	4 io flt	5 plcmem	6	7	8	9 clear	10 zoom
> P L C F A U L T T A B L E									
TOP FAULT DISPLAYED: 00005			TABLE LAST CLEARED: 01-22 05:42:30						
TOTAL FAULTS: 00005			ENTRIES OVERFLOWED: 00000						
			PLC DATE/TIME: 01-22 05:51:18						
FAULT LOCATION	FAULT DESCRIPTION		DATE	TIME					
			M-D	H:	M:	S			
0.2	System configuration mismatch		01-22	05:	50:	45			
0.1	Password access failed		01-22	05:	49:	24			
0.1	Application stack overflow		01-22	05:	48:	58			
0.1	Application stack overflow		01-22	05:	48:	58			
0.1	Failed battery signal		01-22	05:	42:	30			
ID: STOP/FAULT ONLINE L4 ACC: WRITE LOGIC CONFIG EQUAL									
C:\P8\LESSON PRG: LESSON									
REPLACE									

Both tables contain similar information.

- The PLC fault table contains:
  - Fault location.
  - Fault description.
  - Date and time of fault.
- The I/O fault table contains:
  - Fault location.
  - Reference address.
  - Fault category.
  - Fault type.
  - Date and time of fault.

## 1. PLC FAULT TABLE

The Alspa C80-35, C80-25 and C80-05 PLCs maintain additional information on each fault that, because of space limitations on the Alspa P8 screen, is not displayed. This additional fault table information may be viewed by positioning the cursor on the fault and pressing the CTRL and F keys together. A line of hexadecimal characters is displayed on the line directly beneath the fault name, as shown in the example screen below. This is the full fault entry, as stored by the PLC CPU. This additional data, along with suggestions for fixing the fault, may also be viewed by positioning the cursor on the fault and pressing the Zoom (F10) key.

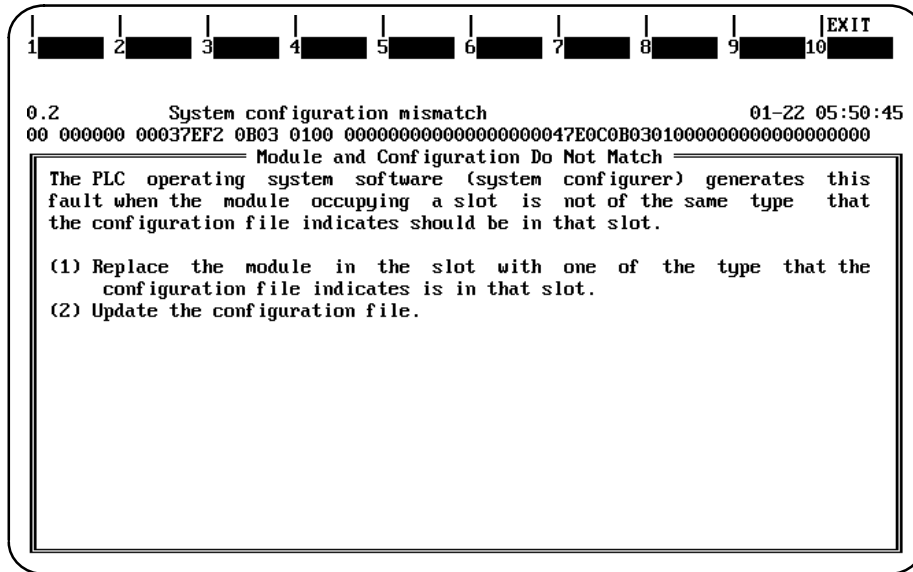

The following diagram identifies each field in the fault entry for the System Configuration Mismatch fault displayed above:

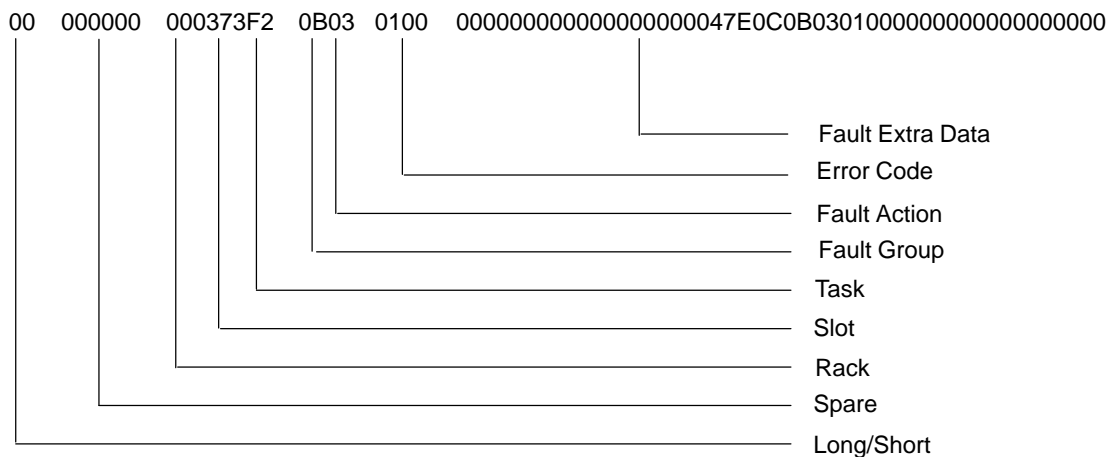

The System Configuration Mismatch fault entry is explained below. (All data is in hexadecimal.)

Field	Value	Description
Long/Short	00	This fault contains 8 bytes of fault extra data.
Rack	00	Main rack (rack 0).
Slot	03	Slot 3.
Task	44	
Fault Group	0B	System Configuration Mismatch fault.
Fault Action	03	FATAL fault.
Error Code	01	

The following paragraphs describe each field in the fault entry. Included are tables describing the range of values each field may have.

### 1.1. Long/Short Indicator

This byte indicates whether the fault contains 8 bytes or 24 bytes of fault extra data.

Type	Code	Fault Extra Data
Short	00	8 bytes
Long	01	24 bytes

### 1.2. Spare

These six bytes are pad bytes, used to make the PLC fault table entry exactly the same length as the I/O fault table entry.

### 1.3. Rack

The rack number ranges from 0 to 7. Zero is the main rack, containing the PLC. Racks 1 to 7 are expansion racks, connected to the PLC through an expansion cable.

### 1.4. Slot

The slot number ranges from 0 to 9. The PLC CPU always occupies slot 1 in the main rack (rack 0).

### 1.5. Task

The task number ranges from 0 to +65535. Sometimes the task number gives additional information for PLC engineers; typically, the task can be ignored.

## 1.6. PLC Fault Group

Fault group is the highest classification of a fault. It identifies the general category of the fault. The fault description text displayed by Alspa P8–25/35/05 software is based on the fault group and the error codes.

Table B.1 lists the possible fault groups in the PLC fault table.

The *Additional PLC Fault Codes* group is declared for the handling of new fault conditions in the system without the PLC having to specifically know the alarm codes. All unrecognized PLC–type alarm codes belong to this group.

**Table B.1 – PLC Fault Groups**

Group Number		Group Name	Fault Action
Decimal	Hexadecimal		
1	1	Loss of, or missing, rack.	Fatal
4	4	Loss of, or missing, option module.	Diagnostic
5	5	Addition of, or extra, rack.	Diagnostic
8	8	Addition of, or extra, option module.	Diagnostic
11	B	System configuration mismatch.	Fatal
12	C	System bus error.	Diagnostic
13	D	PLC CPU hardware failure.	Fatal
14	E	Non-fatal module hardware failure.	Diagnostic
16	10	Option module software failure.	Diagnostic
17	11	Program block checksum failure.	Fatal
18	12	Low battery signal.	Diagnostic
19	13	Constant sweep time exceeded.	Diagnostic
20	14	PLC system fault table full.	Diagnostic
21	15	I/O fault table full.	Diagnostic
22	16	User Application fault.	Diagnostic
–	–	Additional PLC fault codes.	As specified
128	80	System bus failure.	Fatal
129	81	No user's program on power-up.	Informational
130	82	Corrupted user RAM detected.	Fatal
132	84	Password access failure.	Informational
135	87	PLC CPU software failure.	Fatal
137	89	PLC sequence-store failure.	Fatal

## 1.7. Fault Action

Each fault may have one of three actions associated with it. These fault actions are fixed on the Alspa C80–35 PLC and cannot be changed by the user.

**Table B.2 – PLC Fault Actions**

Fault Action	Action Taken by CPU	Code
Informational	Log fault in fault table.	1
Diagnostic	Log fault in fault table. Set fault references.	2
Fatal	Log fault in fault table. Set fault references. Go to STOP mode.	3

## 1.8. Error Code

The error code further describes the fault. Each fault group has its own set of error codes. Table B.3 shows error codes for the PLC Software Error Group (Group 87H).

**Table B.3 – Alarm Error Codes for PLC CPU Software Faults**

<b>Decimal</b>	<b>Hexadecimal</b>	<b>Name</b>
20	14	Corrupted PLC Program Memory.
39	27	Corrupted PLC Program Memory.
82	52	Backplane Communications Failed.
90	5A	User Shut Down Requested.
All others		PLC CPU Internal System Error.

Table B.4 shows the error codes for all the other fault groups.

**Table B.4 – Alarm Error Codes for PLC Faults**

Decimal	Hexadecimal	Name
<i>PLC Error Codes for Loss of Option Module Group</i>		
44	2C	Option Module Soft Reset Failed.
45	2D	Option Module Soft Reset Failed.
255	FF	Option Module Communication Failed.
<i>Error Codes for Reset of, Addition of, or Extra Option Module Group</i>		
2	2	Module Restart Complete.
	All others	Reset of, Addition of, or Extra Option Module.
<i>Error Codes for Option Module Software Failure Group</i>		
1	1	Unsupported Board Type.
2	2	COMREQ – mailbox full on outgoing message that starts the COMREQ.
3	3	COMREQ – mailbox full on response.
5	5	Backplane Communications with PLC; Lost Request.
11	B	Resource (alloc, tbl ovflw, etc.) error.
13	D	User program error.
401	191	Module Software Corrupted; Requesting Reload.
<i>Error Codes for System Configuration Mismatch Group</i>		
8	8	Analog Expansion Mismatch.
10	A	Unsupported Feature.
23	17	Program exceeds memory limits.
<i>Error Codes for System Bus Error Group</i>		
All others		System Bus Error.
<i>Error Codes for Program Block Checksum Group</i>		
3	3	Program or program block checksum failure.
<i>Error Codes for Low Battery Signal</i>		
0	0	Failed battery on PLC CPU or other module.
1	1	Low battery on PLC CPU or other module.
<i>Error Codes for User Application Fault Group</i>		
2	2	PLC Watchdog Timer Timed Out .
5	5	COMREQ – WAIT mode not available for this command.
6	6	COMREQ – Bad Task ID.
7	7	Application Stack Overflow.
<i>Error Codes for System Bus Failure Group</i>		
1	1	Operating system.
<i>Error Codes for Corrupted User RAM on Powerup Group</i>		
1	1	Corrupted User RAM on Power-up.
2	2	Illegal Boolean Opcode Detected.
3	3	PLC_ISCP_PC_OVERFLOW.
4	4	PRG_SYNTAX_ERR.
<i>Error Codes for PLC CPU Hardware Faults</i>		
All codes		PLC CPU Hardware Failure.

## 1.9. Fault Extra Data

This field contains details of the fault entry. Two examples of such data are given below.

### 1.9.1. Corrupted User RAM Group

Four of the error codes in the System Configuration Mismatch group supply fault extra data:

**Table B.5 – PLC Fault Data – Illegal Boolean Opcode Detected**

Fault Extra Data	Model Number Mismatch
[0]	ISCP Fault Register Contents
[1]	Bad OPCODE
[2,3]	ISCP Program Counter
[4,5]	Function Number

### 1.9.2. PLC CPU Hardware Failure (RAM Failure)

For a RAM failure in the PLC CPU (one of the faults reported as a PLC CPU hardware failure), the address of the failure is stored in the first four bytes of the field.

## 1.10. PLC Fault Time Stamp

The six–byte time stamp is the value of the system clock when the fault was recorded by the PLC CPU. (Values are coded in BCD format.)

**Table B.6 – PLC Fault Time Stamp**

Byte Number	Description
1	Seconds.
2	Minutes.
3	Hours.
4	Day of the month.
5	Month.
6	Year.

## 2. I/O FAULT TABLE

The following sample screen displays additional fault table information for the Addition of I/O Module fault listed in the I/O fault table at the beginning of this appendix. This additional fault table information was displayed by positioning the cursor on the fault in the I/O fault table and pressing CTRL-F. This screen may also be displayed by positioning the cursor on the fault and pressing the Zoom (F10) key.

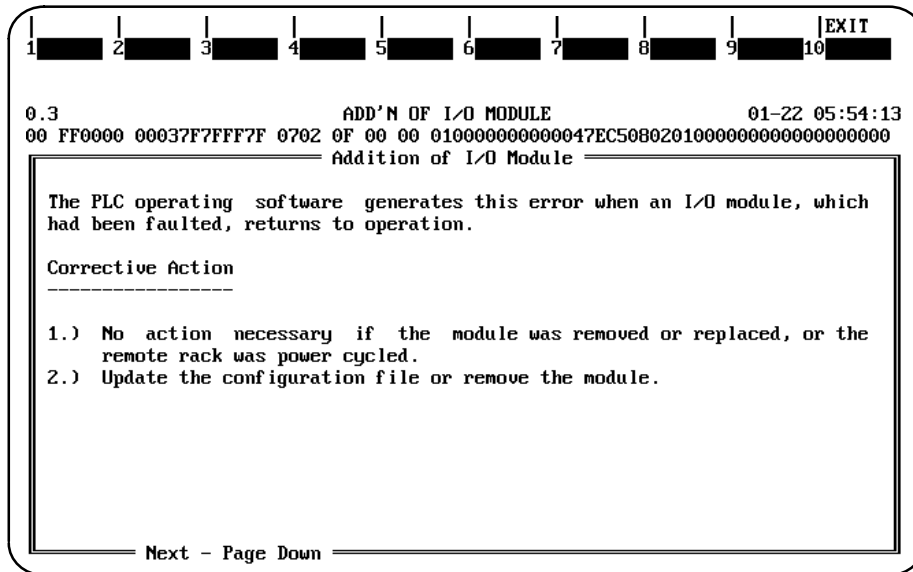

The following diagram identifies the hexadecimal information displayed in each field in the fault entry.

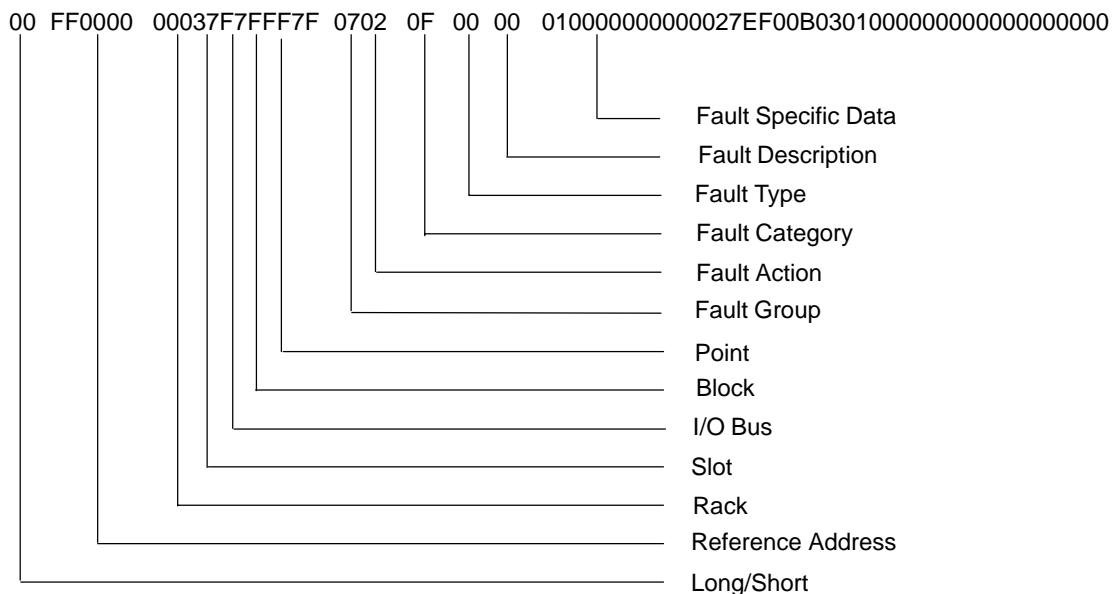

The following paragraphs describe each field in the I/O fault table. Included are tables describing the range of values each field may have.

## 2.1. Long/Short Indicator

This byte indicates whether the fault contains 5 bytes or 21 bytes of fault specific data.

**Table B.7 – I/O Fault Table Format Indicator Byte**

Type	Code	Fault Specific Data
Short	02	5 bytes
Long	03	21 bytes

## 2.2. Reference Address

Reference address is a three–byte address containing the I/O memory type and location (or offset) in that memory which corresponds to the point experiencing the fault. Or, when an Alspa CE80–15 block fault or integral analog module fault occurs, the reference address refers to the first point on the block where the fault occurred.

**Table B.8 – I/O Reference Address**

Byte	Description	Range
0	Memory Type	0 – FF
1–2	Offset	0 – 12K (decimal)

The memory type byte is one of the following values.

**Table B.9 – I/O Reference Address Memory Type**

Name	Value (Hexadecimal)
Analog input	0A
Analog output	0C
Analog grouped	0D
Discrete input	10 or 46
Discrete output	12 or 48
Discrete grouped	1F

## 2.3. I/O Fault Address

The I/O fault address is a six–byte address containing rack, slot, bus, block, and point address of the I/O point which generated the fault. The point address is a word; all other addresses are one byte each. All five values may not be present in a fault.

When an I/O fault address does not contain all five addresses, a 7F hex appears in the address to indicate where the significance stops. For example, if 7F appears in the bus byte, then the fault is a module fault. Only rack and slot values are significant.

## 2.4. Rack

The rack number ranges from 0 to 7. Zero is the main rack, i.e., the one containing the PLC. Racks 1 to 7 are expansion racks, connected to the PLC through a Bus Transmitter Module in the main rack and Bus Receiver Modules in the expansion racks.

## 2.5. Slot

The slot number ranges from 0 to 9. The PLC CPU always occupies slot 1 in the main rack (rack 0).

## 2.6. Point

Point ranges from 1 to 1024 (decimal). It tells which point on the block has the fault when the fault is a point-type fault.

## 2.7. I/O Fault Group

Fault group is the highest classification of a fault. It identifies the general category of the fault. The fault description text displayed by Alspa P8–25/35/05 software is based on the fault group and the error codes.

Table B.10 lists the possible fault groups in the I/O fault table. Group numbers less than 80 (Hex) are maskable faults.

The *Additional I/O Fault Codes* group is declared for the handling of new fault conditions in the system without the PLC having to specifically know the alarm codes. All unrecognized I/O-type alarm codes belong to this group.

**Table B.10 – I/O Fault Groups**

Group Number	Group Name	Fault Action
3	Loss of or missing I/O module.	Diagnostic
7	Addition of or extra I/O module.	Diagnostic
9	IOC or I/O bus fault.	Diagnostic
A	I/O module fault.	Diagnostic
–	Additional I/O fault codes.	As specified

## 2.8. I/O Fault Action

The fault action specifies what action the PLC CPU should take when a fault occurs. Table B.11 lists possible fault actions.

**Table B.11 – I/O Fault Actions**

Fault Action	Action Taken by CPU	Code
Informational	Log fault in fault table.	1
Diagnostic	Log fault in fault table. Set fault references.	2
Fatal	Log fault in fault table. Set fault references. Go to STOP mode.	3

## 2.9. I/O Fault Specific Data

An I/O fault table entry may contain up to 5 bytes of I/O fault specific data.

## 2.10. Symbolic Fault Specific Data

Table B.12 lists data that is required for block circuit configuration.

**Table B.12 – I/O Fault Specific Data**

Decimal Number	Hex Code	Description
<i>Circuit Configuration</i>		
	1	Circuit is an input – tristate.
	2	Circuit is an input.
	3	Circuit is an output.

## 2.11. Fault Actions for Specific Faults

Forced/unforced circuit faults are reported as informational faults. All others are diagnostic or fatal.

The model number mismatch, I/O type mismatch and non-existent I/O module faults are reported in the PLC fault table under the System Configuration Mismatch group. They are not reported in the I/O fault table.

## 2.12. I/O Fault Time Stamp

The six-byte time stamp is the value of the system clock when the fault was recorded by the PLC CPU. Values are coded in BCD format.

**Table B.13 – I/O Fault Time Stamp**

Byte Number	Description
1	Seconds.
2	Minutes
3	Hours.
4	Day of the month.
5	Month.
6	Year.

# Appendix *Instruction Mnemonics*

## C

In Program Display/Edit mode, you can quickly enter or search for a programming instruction by typing the ampersand (&) character followed by the instruction's mnemonic. For some instructions, you can also specify a reference address or nickname, a label, or a location reference address.

This appendix lists the mnemonics of the programming instructions for Alspa P8–25/35/05 programming software. The complete mnemonic is shown in column 3 of this table, and the shortest entry you can make for each instruction is listed in column 4.

At any time during programming, you can display a help screen with these mnemonics by pressing the ALT and I keys.

Function Group	Instruction	Mnemonic					
		All	INT	DINT	BIT	BYTE	WORD
Contacts	Any Contact	&CON	&CON				
	Normally Open Contact	&NOCON	&NOCON				
	Normally Closed Contact	&NCCON	&NCCON				
	Continuation Contact	&CONC	&CONC				
Coils	Any Coil	&COI	&COI				
	Normally Open Coil	&NOCOI	&NOCOI				
	Negated Coil	&NCCOI	&NCCOI				
	Positive Transition Coil	&PCOI	&PCOI				
	Negative Transition Coil	&NCOI	&NCOI				
	SET Coil	&SL	&SL				
	RESET Coil	&RL	&RL				
	Retentive SET Coil	&SM	&SM				
	Retentive RESET Coil	&RM	&RM				
	Retentive Coil	&NOM	&NOM				
	Negated Retentive Coil	&NCM	&NCM				
	Continuation Coil	&COILC	&COILC				
Links	Horizontal Link	&HO	&HO				
	Vertical Link	&VE	&VE				
Timers	On–Delay Timer	&ON	&ON				
	Timer (Elapsed)	&TM	&TM				
	Off–Delay Timer	&OF	&OF				
Counters	Up Counter	&UP	&UP				
	Down Counter	&DN	&DN				

## Instruction Mnemonics

Function Group	Instruction	Mnemonic							
		All	BCD-4	INT	DINT	BIT	BYTE	WORD	REAL
Math	Addition Subtraction Multiplication Division Modulo Square Root Sine Cosine Tangent Inverse Sine Inverse Cosine Inverse Tangent Base 10 Logarithm Natural Logarithm Power of <i>e</i> Power of <i>x</i>	&AD &SUB &MUL &DIV &MOD &SQ &SIN &COS &TAN &ASIN &ACOS &ATAN &LOG &LN &EXP &EXPT		&AD_I &SUB_I &MUL_I &DIV_I &MOD_I &SQ_I	&AD_DI &SUB_DI &MUL_DI &DIV_DI &MOD_DI &SQ_DI				&AD_R &SUB_R &MUL_R &DIV_R &MOD_R &SQ_R
Relational	Equal Not Equal Greater Than Greater or Equal Less Than Less Than or Equal	&EQ &NE &GT &GE &LT &LE		&EQ_I &NE_I &GT_I &GE_I &LT_I &LE_I	&EQ_DI &NE_DI &GT_DI &GE_DI &LT_DI &LE_DI				&EQ_R &NE_R &GT_R &GE_R &LT_R &LE_R
Bit Operation	AND OR Exclusive OR NOT Bit Shift Left Bit Shift Right Bit Rotate Left Bit Rotate Right Bit Test Bit Set Bit Clear Bit Position Masked Compare	&AN &OR &XO &NOT &SHL &SHR &ROL &ROR &BT &BS &BCL &BP &MCM						&AN_W &OR_W &XO_W &NOT_W &SHL_W &SHR_W &ROL_W &ROR_W &BT_W &BS_W &BCL_W &BP_W &MCM_W	
Data Move	Move Block Move Block Clear Shift Register Bit Sequencer Communications Request	&MOV &BLKM &BLKC &SHF &BI &COMMR		&MOV_I &BLKM_I		&MOV_BI  &SHF_BI		&MOV_W &BLKM_W  &AR_W	&MOV_R &BLKM_R
Table	Array Move Search Equal Search Not Equal Search Greater Than Search Greater Than or Equal Search Less Than Search Less Than or Equal	&AR &SRCHE &SRCHN &SRCHGT &SRCHGE &SRCHLT &SRCHLE		&AR_I &SRCHE_I &SRCHN_I &SRCHGT_I &SRCHGE_I &SRCHLT_I &SRCHLE_I	&AR_DI &SRCHE_DI &SRCHN_DI &SRCHGT_DI &SRCHGE_DI &SRCHLT_DI &SRCHLE_DI	&AR_BI	&AR_BY &SRCHE_BY &SRCHN_BY &SRCHGT_BY &SRCHGE_BY &SRCHLT_BY &SRCHLE_BY	&AR_W &SRCHE_W &SRCHN_W &SRCHGT_W &SRCHGE_W &SRCHLT_W &SRCHLE_W	
Conversion	Convert to Integer Convert to Double Integer Convert to BCD-4 Convert to REAL Convert to WORD Truncate to Integer Truncate to Double Integer	&TO_INT &TO_DINT &BCD4 &TO_REAL &TO_W &TRINT &TRDINT	&TO_INT_BCD4	&TO_BCD4_I &TO_REAL_I	&TO_REAL_DI			&TO_REAL_W	&BCD4_R
Control	Call a Subroutine Do I/O PID – ISA Algorithm PID – IND Algorithm End Rung Explanation System Services Request Master Control Relay End Master Control Relay Nested Master Control Relay Nested End Master Cnd Relay Jump Nested Jump Label Nested Label	&CA &DO &PIDIS &PIDIN &END &COMME &SV &MCR &ENDMCR &MCRN &ENDMCR N &JUMP &JUMPN &LABEL &LABELN	&JUMP &JUMPN &LABEL &LABELN						

# Appendix *Key Functions*

## D

This appendix lists the keyboard functions that are active in the software environment. This information may also be displayed on the programmer screen by pressing ALT-K to access key help.

Key Sequence	Description	Key Sequence	Description
<b>Keys Available Throughout the Software Package</b>			
ALT-A	Abort.	CTRL-Break	Exit package.
ALT-C	Clear field.	Esc	Zoom out.
ALT-M	Change Programmer mode.	CTRL-Home	Previous command-line contents.
ALT-R	Change PLC Run/Stop state.	CTRL-End	Next command-line contents.
ALT-E	Toggle status area.	CTRL- ←	Cursor left within the field.
ALT-J	Toggle command line.	CTRL- →	Cursor right within the field.
ALT-L	List directory files.	CTRL-D	Decrement reference address.
ALT-P	Print screen.	CTRL-U	Increment reference address.
ALT-H	Help.	Tab	Change/increment field contents.
ALT-K	Key help.	Shift-Tab	Change/decrement field contents.
ALT-I	Instruction mnemonic help.	Enter	Accept field contents.
ALT-N	Toggle display options.	CTRL-E	Display last system error.
ALT-T	Start Teach mode.	F12 or Keypad -	Toggle discrete reference.
ALT-Q	Stop Teach mode.	F11 or Keypad *	Override discrete reference.
ALT-n	Playback file n (n = 0 to 9).		
<b>Keys Available in the Program Editor Only</b>			
ALT-B	Toggle text editor bell.	Keypad +	Accept rung.
ALT-D	Delete rung element/Delete rung.	Enter	Accept rung.
ALT-S	Store block to PLC and disk.	CTRL-PgUp	Previous rung.
ALT-X	Display zoom level.	CTRL-PgDn	Next rung.
ALT-U	Update disk.	~	Horizontal shunt.
ALT-V	Variable table window.		Vertical shunt.
ALT-F2	Go to operand reference table.	Tab	Go to the next operand field.
<b>Special Keys</b>			
ALT-O	Password override. Available only on the Password screen in the configuration software.		

The Help table on the next page contains a listing of the key help and also the instruction mnemonics help text for Alspa P8-25/35/05 software.

<b>Alspa P8 Key Help (ALT-K)</b>	
<b>Key Sequence</b>	<b>Description</b>
<i>Keys Available throughout the Software Package</i>	
ALT-A	Abort.
ALT-C	Clear field.
ALT-M	Change Programmer mode.
ALT-R	Change PLC Run/Stop state.
ALT-E	Toggle status area.
ALT-J	Toggle the command line.
ALT-L	List directory files.
ALT-P	Print screen.
ALT-H	Help.
ALT-K	Key help.
ALT-I	Instruction mnemonic help.
ALT-T	Start Teach mode.
ALT-Q	Stop Teach mode.
ALT-n	Playback file n (n = 0 thru 9).
CTRL-Break	Exit package.
Esc	Zoom out.
CTRL-Home	Previous command line.
CTRL-End	Next command line.
CTRL-←	Cursor left within the field.
CTRL-→	Cursor right within the field.
CTRL-D	Decrement reference address.
CTRL-U	Increment reference address.
Tab	Change/increment field contents.
Shift-Tab	Change/decrement field contents.
Enter	Accept field contents.
CTRL- E	Display last system error.
F12 or Keypad –	Toggle discrete reference.
F11 or Keypad *	Override discrete reference.

<b>Alspla P8 Key Help (ALT-K)</b>	
<b>Key Sequence</b>	<b>Description</b>
<i>Keys Available in the Program Editor Only</i>	
ALT-B	Toggle text editor bell.
ALT-D	Delete rung element.
ALT-S	Store block to PLC and disk.
ALT-X	Display zoom level.
ALT-N	Toggle nickname/reference address.
ALT-U	Update disk.
ALT-V	Variable table window.
Keypad +	Accept rung.
Enter	Accept rung.
CTRL-PgUp	Previous rung.
CTRL-PgDn	Next rung.
~	Horizontal shunt.
	Vertical shunt.
Tab	Go to the next operand field.
<i>Special Keys</i>	
ALT-O	Password override. Available only on the Password screen in the configuration software.

Alspa P8 Instruction Mnemonics Help (ALT-I)			
Instruction	Mnemonic	Instructions	Mnemonic
Any Contact (search)	&CON	Bit Operation (cont'd)	
-] [-	&NOCON	Shift Left	&SHL
-]/[-	&NCCON	Shift Right	&SHR
<+>—	&CONC	Rotate Left	&ROL
Any Coil (search)	&COI	Rotate Right	&ROR
-( )-	&NOCOI	Test a Bit	&BT
-( /)-	&NCCOI	Set a bit to 1	&BS
-(↑)-	&PCOI	Set a bit to 0	&BCL
-(↓)-	&NCOI	Locate a bit set to 1	&BP
-(S)-	&SL	Data Move	
-(R)-	&RL	Move	&MOV
-(SM)-	&SM	Block Move	&BLKM
-(RM)-	&RM	Block Clear	&BLKC
-(M)-	&NOMC	Shift Register	&SHF
-(/M)-	&NCM	Bit Sequencer	&BI
—<+>	&COILC	Comm Request	&COMMR
Links		Table (Search for)	
—	&HO	Array Move	&AR
	&VE	Equal	&SRCHE
Timers		Not Equal	&SRCHN
On Delay Timer	&ON	Greater Than	&SRCHGT
Elapsed Timer	&TM	Greater Than/Equal	&SRCHGE
Off Delay Timer	&OF		
Counters		Less Than	&SRCHLT
Up Counter	&UP	Less Than/Equal	&SRCHLE
Down Counter	&DN	Conversion	
Arithmetic		Convert to Integer	&I_BCD4
Add	&AD	Convert to BCD-4	&BCD4
Subtract	&SUB	Control	
Multiply	&MUL	Call	&CA
Divide	&DIV	Do I/O	&DO
Modulo Divide	&MOD	PID - IND Algorithm	&PIDIS
Square Root	&SQ	PID - ISA Algorithm	&PIDIN
Relational		End	&END
Equal	&EQ	Comment	&COMME
Not Equal	&NE	Service Request	&SV
Greater Than	&GT	Non-nested MCR	&MCR
Greater Than/Equal	&GE	End non-nested MCR	&ENDMCR
Less Than	&LT	Nested MCR	&MCRN
Less Than/Equal	&LE	End nested MCR	&ENDMCRN
Bit Operation		JUMP	&JUMP
AND	&AN	JUMPN	&JUMPN
OR	&OR	LABEL	&LABEL
Exclusive OR	&XO	LABELN	&LABELN
Invert (NOT)	&NOT		

Instructions with a type modifier, listed in the following table, may have the type modifier appended with an underscore ( \_ ) as a separator. For example & ADD\_INT.

---

<b>Alspa P8 Instruction Mnemonics Help (ALT-I)</b>		
<b>Instruction Type:</b>	<b>Modifier:</b>	<b>Used with:</b>
Signed Integer	_I	Math, Relational, Data Move, & Table
Double Precision Integer	_DI	Math, Relational, & Table
Bit	_BI	Data Move & Table
Byte	_BY	Table
Word	_W	Bit Operation, Data Move, & Table
BCD4	_BCD4	Conversion
Tenths of Seconds	_TEN	Timers
Hundredths of Seconds	_HUN	Timers



There are a few considerations you need to understand when using floating-point numbers. The first section discusses these general considerations. Refer to page E-5 and following for instructions on entering and displaying floating-point numbers.

## 1. FLOATING-POINT NUMBERS

Alspa P8 software provides the ability to edit, display, store and retrieve numbers with real values. Some functions operate on floating-point numbers. However, in order to use floating-point numbers with Alspa P8-35/25/05 software, you must have a 352 CPU. Floating-point numbers are represented in decimal scientific notation, with a display of six significant digits.

<b>Note</b>
-------------

In this manual, the terms “floating-point” and “REAL” are used interchangeably to describe the floating-point number display/entry feature of Alspa P8 software.

In Alspa P8 software, the following format is used. For numbers in the range 999999999 to 0.0001, the display has no exponent and up to six or seven significant digits. For example:

<b>Entered</b>	<b>Displayed</b>	<b>Description</b>
0.000123456789	+0.0001234567	Ten digits, six or seven significant.
-12.345e-2	-0.1234500	Seven digits, six or seven significant.
1234	+1234.000	Seven digits, six or seven significant.

Outside the range listed above, only six significant digits are displayed and the display has the form:

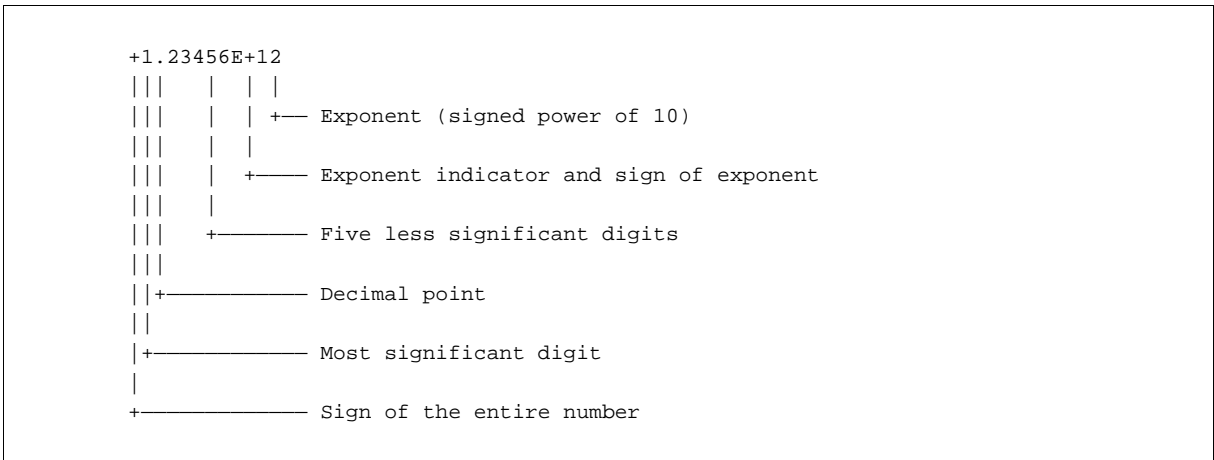

## 2. VALUES OF FLOATING-POINT NUMBERS

Use the following table to calculate the value of a floating-point number from the binary number stored in two registers.

Exponent (e)	Mantissa (f)	Value of Floating Point Number
255	Non-zero	Not a valid number (NaN).
255	0	$-1^s * \infty$
$0 < e < 255$	Any value	$-1^s * 2^{e-127} * 1.f$
0	Non-zero	$-1^s * 2^{-126} * 0.f$
0	0	0

- f = the mantissa. The mantissa is a binary fraction.
- e = the exponent. The exponent is an integer E such that E+127 is the power of 2 by which the mantissa must be multiplied to yield the floating-point value.
- s = the sign bit.
- \* = the multiplication operator.

For example, consider the floating-point number 12.5. The IEEE floating-point binary representation of the number is:

**01000001 01001000 00000000 00000000**

or 41480000 hex in hexadecimal form. The most significant bit (the sign bit) is zero (s=0). The next eight most significant bits are 10000010 or 130 decimal (e=130).

The mantissa is stored as a decimal binary number with the decimal point preceding the most significant of the 23 bits. Thus, the most significant bit in the mantissa is a multiple of  $2^{-1}$ , the next most significant bit is a multiple of  $2^{-2}$  and so on to the least significant bit, which is a multiple of  $2^{-23}$ . The final 23 bits (the mantissa) are:

1001000 00000000 00000000

The value of the mantissa, then, is 0.5625 (that is,  $2^{-1} + 2^{-4}$ ).

Since  $e > 0$  and  $e < 255$ , we use the third formula in the table above:

$$\begin{aligned}
 \text{number} &= -1^s * 2^{e-127} * 1.f \\
 &= -1^0 * 2^{130-127} * 1.5625 \\
 &= 1 * 2^3 * 1.5625 \\
 &= 8 * 1.5625 \\
 &= 12.5
 \end{aligned}$$

Thus, you can see that the above binary representation is correct.

The range of numbers that can be stored in this format is from  $\pm 1.401298\text{E-}45$  to  $\pm 3.402823\text{E+}38$  and the number zero.

### 3. ERRORS IN FLOATING-POINT NUMBERS AND OPERATIONS

Overflow occurs when a number greater than 3.402823E+38 or less than -3.402823E+38 is generated by a REAL function. When this occurs, the ok output of the function is set OFF and the result is set to positive infinity (for a number greater than 3.402823E+38) or negative infinity (for a number less than -3.402823E+38). You can determine where this occurs by testing the sense of the ok output.

POS\_INF = 7F800000h – IEEE positive infinity representation in hex.  
 NEG\_INF = FF800000h – IEEE negative infinity representation in hex.

If the infinities produced by overflow are used as operands to other REAL functions, they may cause an undefined result. This undefined result is referred to as a NaN (Not a Number). For example, the result of adding positive infinity to negative infinity is undefined. When the ADD\_REAL function is invoked with positive infinity and negative infinity as its operands, it produces a NaN for its result.

Each REAL function capable of producing a NaN produces a specialized NaN which identifies the function.

NaN\_ADD. = 7F80FFFFh – Real addition error value in hex.  
 NaN\_SUB = 7F81FFFFh – Real subtraction error value in hex.  
 NaN\_MUL = 7F82FFFFh – Real multiplication error value in hex.  
 NaN\_DIV = 7F83FFFFh – Real division error value in hex.  
 NaN\_SQRT = 7F84FFFFh – Real square root error value in hex.  
 NaN\_LOG = 7F85FFFFh – Real logarithm error value in hex.  
 NaN\_POW0 = 7F86FFFFh – Real exponent error value in hex.  
 NaN\_SIN = 7F87FFFFh – Real sine error value in hex.  
 NaN\_COS = 7F88FFFFh – Real cosine error value in hex.  
 NaN\_TAN = 7F89FFFFh – Real tangent error value in hex.  
 NaN\_ASIN = 7F8AFFFFh – Real inverse sine error value in hex.  
 NaN\_ACOS = 7F8BFFFFh – Real inverse cosine error value in hex.  
 NaN\_BCD = 7F8CFFFFh – BCD-4 to real error.  
 REAL\_INDEF = FFC00000 – Real indefinite, divide 0 by 0 error.

When a NaN result is fed into another function, it passes through to the result. For example, if a NaN\_ADD is the first operand to the SUB\_REAL function, the result of the SUB\_REAL is NaN\_ADD. If both operands to a function are NaNs, the first operand will pass through. Because of this feature of propagating NaNs through functions, you can identify the function where the NaN originated.

**Note**

For NaN, the ok output is OFF (not energized).

## 4. ENTERING AND DISPLAYING FLOATING-POINT NUMBERS

In the mantissa, up to six or seven significant digits of precision may be entered and stored however, Alspa P8 software will display only the first six of these digits. The mantissa may be preceded by a positive or negative sign. If no sign is entered, the floating-point number is assumed to be positive.

If an exponent is entered, it must be preceded by the letter **E** or **e** and the mantissa must contain a decimal point to avoid mistaking it for a hexadecimal number. The exponent may be preceded by a sign but, if none is provided, it is assumed to be positive. If no exponent is entered, it is assumed to be zero. No spaces are allowed in a floating-point number.

To provide ease-of-use, several formats are accepted in both command-line and field data entry. These formats include an integer, a decimal number or a decimal number followed by an exponent. These numbers are converted to a standard form for display once the user has entered the data and pressed the **Enter** key.

Examples of valid floating-point number entries and their normalized display are shown below.

Entered	Displayed
250	+250.0000
+4	+4.000000
-2383019	-2383019.
34.	+34.00000
-0.0036209	-0.003620900
12.E+9	+1.20000E+10
-0.0004E-11	-4.00000E-15
731.0388	+731.0388
99.20003e-29	+9.92000E-28

Examples of invalid floating-point number entries are shown below.

Invalid Entry	Explanation
-433E23	Missing decimal point.
10e-19	Missing decimal point.
10.e19	The mantissa cannot contain spaces between digits or characters. This is accepted as 10.e0 and an error message is displayed.
4.1e19	The exponent cannot contain spaces between digits or characters. This is accepted as 4.1e0 and an error message is displayed.

**Internal Format of Floating-Point Numbers**

Floating-point numbers are stored in single precision IEEE-standard format. This format requires 32 bits, which translates to two (adjacent) 16-bit PLC registers. The encoding of the bits is diagrammed below.

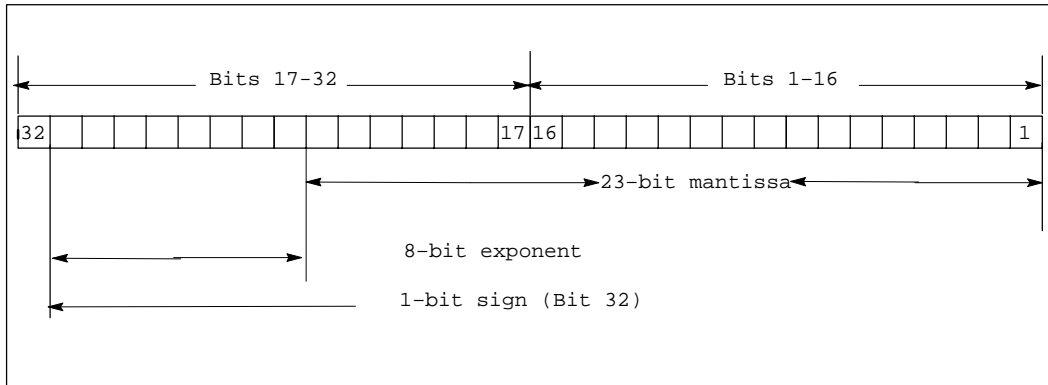

Register use by a single floating-point number is diagrammed below. In this diagram, if the floating-point number occupies registers R5 and R6, for example, then R5 is the least significant register and R6 is the most significant register.

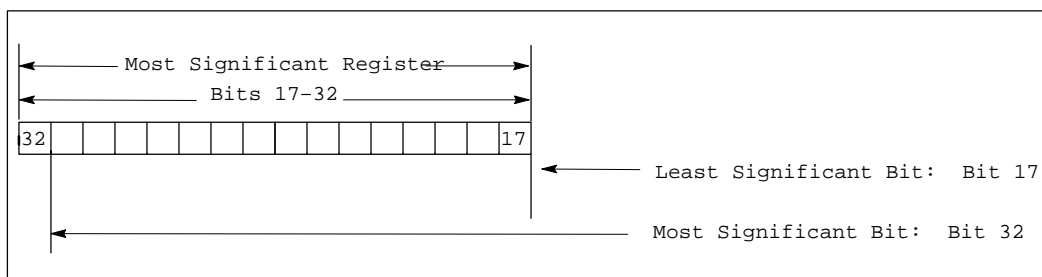
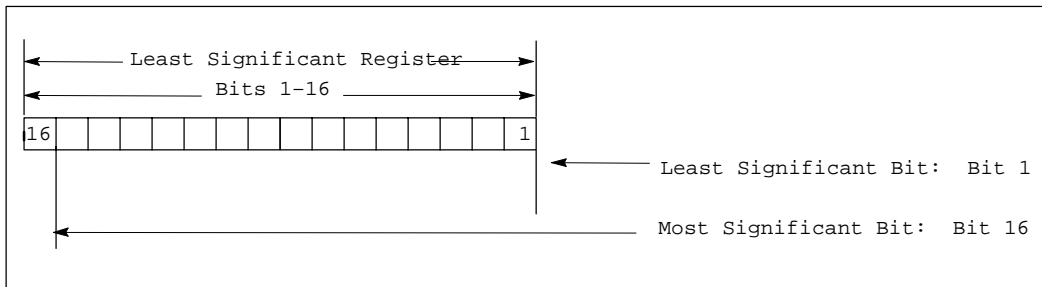

## Numbers

351 and 352 CPUs: changing mode with key switch, 2–12

351 and 352 CPUs: key switch, 2–12

## A

ACOS, 4–30

ADD, 4–23

ADD\_IOM, 2–23

ADD\_SIO, 2–23

Addition function, 4–23

Addition of I/O module, 3–19

Alarm, 3–2

Alarm error codes, B–6

Alarm processor, 3–2

Alspa C80–05 Micro PLC I/O system, 2–34  
Micro CPU and I/O, 2–38

Alspa C80–25 PLC I/O system, 2–34  
model 25 I/O modules, 2–37

Alspa C80–35 PLC I/O system, 2–34  
default conditions for model 35 output modules, 2–36  
diagnostic data, 2–37  
global data, 2–37  
I/O data formats, 2–36  
I/O structure, 2–34  
model 35 I/O modules, 2–35

ALT keys, D–1

ALW\_OFF, 2–22

ALW\_ON, 2–22

AND, 4–41

ANY\_FLT, 2–23

APL\_FLT, 2–23

Application fault, 3–13

Application program logic scan, 2–8

ARRAY\_MOVE, 4–76

ASIN, 4–30

ATAN, 4–30

## B

BAD\_PWD, 2–23

BAD\_RAM, 2–23

Base 10 logarithm function, 4–32

Battery signal, low, 3–12

BCD–4, 2–21 , 4–82

BCLR, 4–52

BIT, 2–21

Bit clear function, 4–52

Bit operation functions, 4–40

AND, 4–41

BCLR, 4–52

BPOS, 4–54

BSET, 4–52

BTST, 4–51

MCMP, 4–56

NOT, 4–46

OR, 4–41

ROL, 4–49

ROR, 4–49

SHL, 4–47

SHR, 4–47

XOR, 4–44

Bit position function, 4–54

Bit sequencer function, 4–69

Bit set function, 4–52

Bit test function, 4–51

BITSEQ, 4–69

memory required, 4–69

BLKCLR, 4–65

BLKMOV, 4–63

Block clear function, 4–65

Block locking feature, 2–32

EDITLOCK, 2–32

VIEWLOCK, 2–32

Block move function, 4–63

BPOS, 4–54

BSET, 4–52

BTST, 4–51

BYTE, 2–21

## C

CALL, 4–91

- Call function, 4-91
  - CFG\_MM, 2-23
  - Checksum calculation, 2-9
  - Checksum failure, program block, 3-12
  - Clocks, 2-29
    - elapsed time clock, 2-29
    - time-of-day clock, 2-29
  - Coil check feature, 2-24
  - Coils, 4-2, 4-4
    - continuation coil, 4-8
    - negated coil, 4-4
    - negated retentive coil, 4-4
    - negative transition coil, 4-5
    - positive transition coil, 4-5
    - RESET coil, 4-6
    - retentive coil, 4-4
    - retentive RESET coil, 4-7
    - retentive SET coil, 4-6
    - SET coil, 4-5
  - COMMENT, 4-104
  - Comment function, 4-104
  - COMMREQ, 4-72
  - Communication request function, 4-72
  - Communications failure during store, 3-17
  - Communications with the PLC, 2-11
  - Configuration, 4-1
  - Configuration mismatch, system, 3-11
  - Constant sweep time exceeded, 3-12
  - Constant sweep time mode, 2-11, 2-30
  - Constant sweep timer, 2-30
  - Contacts, 4-2
    - continuation contact, 4-8
    - normally closed contact, 4-3
    - normally open contact, 4-3
  - Continuation coil, 4-8
  - Continuation contact, 4-8
  - Control functions, 4-90
    - CALL, 4-91
    - COMMENT, 4-104
    - DOIO, 4-92
      - enhanced DOIO for the model 331 and 341 CPUs, 4-95
    - END, 4-97
    - ENDMCR, 4-100
    - Instruction timing, CPU, A-1
    - JUMP, 4-101
    - LABEL, 4-103
    - MCR, 4-97
    - PID, 4-123
    - SVCREQ, 4-104
  - Conversion functions, 4-82
    - BCD-4, 4-82
    - DINT, 4-85
    - INT, 4-83
    - REAL, 4-86
    - TRUN, 4-88
    - WORD, 4-87
  - Convert to BCD-4 function, 4-82
  - Convert to double precision signed integer function, 4-85
  - Convert to Real function, 4-86
  - Convert to signed integer function, 4-83
  - Convert to Word function, 4-87
  - Corrupted memory, 3-9
  - Corrupted user program on power-up, 3-14
  - COS, 4-30
  - Cosine function, 4-30
  - Counters, 4-9
    - DNCTR, 4-19
    - function block data, 4-9
    - UPCTR, 4-18
  - CPU sweep, 2-2
  - CTRL keys, D-1
  - CTRL-F, B-3, B-9
  - CTRL-F to display hexadecimal fault information, 3-8
- ## D
- Data move functions, 4-60
    - BITSEQ, 4-69
    - BLKCLR, 4-65
    - BLKMOV, 4-63
    - COMMREQ, 4-72
    - MOVE, 4-60
    - SHFR, 4-66
  - Data retentiveness, 2-20
  - Data types, 2-21
    - BCD-4, 2-21
    - BIT, 2-21

BYTE, 2–21  
DINT, 2–21  
INT, 2–21  
REAL, 2–21  
WORD, 2–21

Defaults conditions for model 35 output modules, 2–36

DEG, 4–34

Diagnostic data, 2–37

Diagnostic faults, 3–4  
addition of I/O module, 3–19  
application fault, 3–13  
constant sweep time exceeded, 3–12  
loss of I/O module, 3–19  
loss of, or missing, option module, 3–10  
low battery signal, 3–12  
reset of, addition of, or extra, option module, 3–10

DINT, 2–21 , 4–85

Discrete references, 2–19  
discrete inputs, 2–19  
discrete internal, 2–19  
discrete outputs, 2–19  
discrete temporary, 2–19  
global data, 2–19  
system references, 3–5  
system status, 2–19 , 2–22

DIV, 4–23

Division function, 4–23

DNCTR, 4–19

Do I/O function, 4–92  
enhanced DO I/O function for the model 331 and 341 CPUs, 4–95

DOIO, 4–92  
enhanced DOIO for the model 331 and 341 CPUs, 4–95

Double precision signed integer, 2–21

Down counter, 4–19

## E

EDITLOCK, 2–32

Elapsed time clock, 2–29

END, 4–97

End function, 4–97

End master control relay function, 4–100

ENDMCR, 4–100

Enhanced DO I/O function for the model 331 and 341 CPUs, 4–95

EQ, 4–35

Equal function, 4–35

Error codes, B–6

EXP, 4–32

Exponential functions, 4–32  
power of e, 4–32  
power of X, 4–32

EXPT, 4–32

External I/O failures, 3–2

## F

Fatal faults, 3–4  
communications failure during store, 3–17  
corrupted user program on power-up, 3–14  
option module software failure, 3–11  
PLC CPU system software failure, 3–15  
program block checksum failure, 3–12  
system configuration mismatch, 3–11

Fault action, 3–4  
diagnostic faults, 3–4  
fatal faults, 3–4  
I/O fault action, B–12  
informational faults, 3–4  
PLC fault action, B–5

Fault actions, 3–10

Fault category, 3–18

Fault description, 3–18

Fault effects, additional, 3–5

Fault explanations and correction, 3–1  
accessing additional fault information, 3–8  
addition of I/O module, 3–19  
application fault, 3–13  
communications failure during store, 3–17  
constant sweep time exceeded, 3–12  
corrupted user program on power-up, 3–14  
CTRL–F to display hexadecimal fault information, 3–8 , B–3 , B–9  
fault category, 3–18  
fault description, 3–18  
fault handling, 3–2  
fault type, 3–18  
hexadecimal display of fault information, 3–8 , B–3 , B–9

- I/O fault group, B-11
  - I/O fault table, 3-7
  - I/O fault table explanations, 3-18
  - interpreting a fault, B-1
  - loss of I/O module, 3-19
  - loss of, or missing, option module, 3-10
  - low battery signal, 3-12
  - no user program present, 3-13
  - non-configurable faults, 3-10
  - option module software failure, 3-11
  - password access failure, 3-14
  - PLC CPU system software failure, 3-15
  - PLC fault group, B-5
  - PLC fault table, 3-6
  - PLC fault table explanations, 3-9
  - program block checksum failure, 3-12
  - reset of, addition of, or extra, option module, 3-10
  - system configuration mismatch, 3-11
- Fault group, B-5 , B-11
- Fault handling, 3-2
- alarm processor, 3-2
  - fault action, 3-4
- Fault references, 3-4
- definitions of, 3-5
- Fault type, 3-18
- Faults, 3-2
- accessing additional fault information, 3-8
  - actions, 3-10
  - addition of I/O module, 3-19
  - additional fault effects, 3-5
  - application fault, 3-13
  - classes of faults, 3-2
  - communications failure during store, 3-17
  - constant sweep time exceeded, 3-12
  - corrupted user program on power-up, 3-14
  - CTRL-F to display hexadecimal fault information, 3-8 , B-3 , B-9
  - error codes, B-6
  - explanations and correction, 3-1
  - external I/O failures, 3-2
  - fault action, 3-4
  - hexadecimal display of fault information, 3-8 , B-3 , B-9
  - I/O fault action, B-12
  - I/O fault group, B-11
  - I/O fault table, 3-3 , 3-7
  - I/O fault table explanations, 3-18
  - internal failures, 3-2
  - interpreting a fault, B-1
  - loss of I/O module, 3-19
  - loss of, or missing, option module, 3-10
  - low battery signal, 3-12
  - no user program present, 3-13
  - operational failures, 3-2
  - option module software failure, 3-11
  - password access failure, 3-14
  - PLC CPU system software failure, 3-15
  - PLC fault action, B-5
  - PLC fault group, B-5
  - PLC fault table, 3-3 , 3-6
  - PLC fault table explanations, 3-9
  - program block checksum failure, 3-12
  - references, 3-4
  - reset of, addition of, or extra, option module, 3-10
  - system configuration mismatch, 3-11
  - system reaction to faults, 3-3
- Faults, interpreting, B-1
- Flash protection on 351 and 352 CPUs, 2-12
- Floating-point numbers, E-1
- entering and displaying floating-point numbers, E-5
  - errors in floating-point numbers and operations, E-4
  - internal format of floating-point numbers, E-6
  - values of floating-point numbers, E-2
- FST\_SCN, 2-22
- Function block parameters, 2-25
- Function block structure, 2-24
- coil check feature, 2-24
  - format of program function blocks, 2-24
  - format of relays, 2-24
  - function block parameters, 2-25
  - power flow, 2-26
- ## G
- GE, 4-35
- Global data, 2-37
- Global data references, 2-19
- Greater than function, 4-35
- Greater than or equal function, 4-35
- GT, 4-35

## H

Hexadecimal display of fault information, 3-8 , B-3 , B-9

Horizontal link, 4-7

Housekeeping, 2-8

HRD\_CPU, 2-23

HRD\_FLT, 2-23

HRD\_SIO, 2-23

## I

I/O data formats, 2-36

I/O fault table, 3-3 , 3-7 , B-1 , B-9  
CTRL-F for hexadecimal display of fault,  
3-8

explanations, 3-18

fault action, B-12

fault actions for specific faults, B-12

fault address, B-10

fault group, B-11

fault specific data, B-12

fault time stamp, B-12

hexadecimal display of fault information,  
3-8 , B-3 , B-9

interpreting a fault, B-1

long/short indicator, B-10

point, B-11

rack, B-11

reference address, B-10

slot, B-11

symbolic fault specific data, B-12

I/O structure, Alspa C80-35 PLC, 2-34

I/O system, Alspa C80-05 PLC, 2-34  
Micro CPU and I/O, 2-38

I/O system, Alspa C80-25 PLC, 2-34  
model 25 I/O modules, 2-37

I/O system, Alspa C80-35 PLC, 2-34  
default conditions for model 35 output  
modules, 2-36  
diagnostic data, 2-37  
global data, 2-37  
I/O data formats, 2-36  
model 35 I/O modules, 2-35

Informational faults, 3-4  
no user program present, 3-13  
password access failure, 3-14

Input references, discrete, 2-19

Input register references, analog, 2-18

Input scan, 2-8

Instruction mnemonics, C-1

Instruction set, 4-1  
bit operation functions, 4-40  
control functions, 4-90  
conversion functions, 4-82  
data move functions, 4-60  
math functions, 4-23  
relational functions, 4-35  
relay functions, 4-2  
table functions, 4-75  
timers and counters, 4-9

Instructions, programming, 4-1  
bit operation functions, 4-40  
control functions, 4-90  
conversion functions, 4-82  
data move functions, 4-60  
instruction mnemonics, C-1  
math functions, 4-23  
relational functions, 4-35  
relay functions, 4-2  
table functions, 4-75  
timers and counters, 4-9

INT, 2-21 , 4-83

Internal failures, 3-2

Internal references, discrete, 2-19

Inverse cosine function, 4-30

Inverse sine function, 4-30

Inverse tangent function, 4-30

IO\_FLT, 2-23

IO\_FULL, 2-22

IO\_PRES, 2-23

## J

JUMP, 4-101

Jump instruction, 4-101

## K

Key switch on 351 and 352 CPUs, 2-12

## L

LABEL, 4-103

Label instruction, 4-103

LE, 4–35  
Less than function, 4–35  
Less than or equal function, 4–35  
Levels, privilege, 2–31  
    change requests, 2–32  
Links, horizontal and vertical, 4–7  
LN, 4–32  
Locking/unlocking subroutines, 2–32  
LOG, 4–32  
Logarithmic functions, 4–32  
    base 10 logarithm, 4–32  
    natural logarithm, 4–32  
Logic program checksum calculation, 2–9  
Logic solution, 2–8  
Logical AND function, 4–41  
Logical NOT function, 4–46  
Logical OR function, 4–41  
Logical XOR function, 4–44  
LOS\_IOM, 2–23  
LOS\_SIO, 2–23  
Loss of I/O module, 3–19  
Loss of, or missing, option module, 3–10  
Low battery signal, 3–12  
LOW\_BAT, 2–23  
LST\_SCN, 2–22  
LT, 4–35

## M

Maintenance, 3–1  
Masked compare function, 4–56  
Master control relay function, 4–97  
Math functions, 4–23  
    ACOS, 4–30  
    ADD, 4–23  
    ASIN, 4–30  
    ATAN, 4–30  
    COS, 4–30  
    DEG, 4–34  
    DIV, 4–23  
    EXP, 4–32

EXPT, 4–32  
LN, 4–32  
LOG, 4–32  
MOD, 4–27  
MUL, 4–23  
RAD, 4–34  
SIN, 4–30  
SQRT, 4–29  
SUB, 4–23  
TAN, 4–30  
MCR, 4–97  
Memory, corrupted, 3–9  
Micro Models, 2–38  
Mnemonics, instruction, C–1  
MOD, 4–27  
Model 25 I/O modules, 2–37  
Model 35 I/O modules, 2–35  
Modulo function, 4–27  
MOVE, 4–60  
Move function, 4–60  
MSKCMP, 4–56  
MUL, 4–23  
Multiplication function, 4–23

## N

Natural logarithm function, 4–32  
NE, 4–35  
Negated coil, 4–4  
Negated retentive coil, 4–4  
Negative transition coil, 4–5  
No user program present, 3–13  
Normally closed contact, 4–3  
Normally open contact, 4–3  
NOT, 4–46  
Not equal function, 4–35

## O

OFDT, 4–15  
Off-delay timer, 4–15  
On-delay timer, 4–10 , 4–13

ONDTR, 4–10  
Operation of system, 2–1  
Operational failures, 3–2  
Option module software failure, 3–11  
OR, 4–41  
Output references, discrete, 2–19  
Output register references, analog, 2–18  
Output scan, 2–8  
OV\_SWP, 2–23  
Overrides, 2–20  
OVR\_PRE, 2–22

## P

Password access failure, 3–14  
Passwords, 2–31  
PB\_SUM, 2–23  
PCM communications with the PLC, 2–11  
Periodic subroutines, 2–18  
PID, 4–123  
PLC CPU system software failure, 3–15  
PLC fault table, 3–3, 3–6, B–2, B–3  
    CTRL–F for hexadecimal display of fault, 3–8  
    error codes, B–6  
    explanations, 3–9  
    fault action, B–5  
    fault extra data, B–8  
    fault group, B–5  
    fault time stamp, B–8  
    hexadecimal display of fault information, B–3, B–9  
    interpreting a fault, B–1  
    long/short indicator, B–4  
    rack, B–4  
    slot, B–4  
    spare, B–4  
    task, B–4  
PLC sweep, 2–1  
    application program logic scan, 2–8  
    constant sweep time mode, 2–11, 2–30  
    housekeeping, 2–8  
    input scan, 2–8  
    logic program checksum calculation, 2–9  
    logic solution, 2–8  
    output scan, 2–8  
    PCM communications with the PLC, 2–11  
    programmer communications window, 2–9  
    scan time contributions, 2–5  
    scan time contributions for 351 CPUs, 2–6  
    standard program sweep mode, 2–2  
    standard program sweep variations, 2–11  
    STOP mode, 2–12  
    sweep time calculation, 2–7  
    sweep time contribution, 2–4  
    system communications window, 2–10  
PLC system operation, 2–1  
PLC\_BAT, 2–22  
Positive transition coil, 4–5  
Power flow, 2–26  
Power of e function, 4–32  
Power of X function, 4–32  
Power–down, 2–29  
Power–up, 2–27  
Power–up and power–down sequences, 2–27  
    power–down, 2–29  
    power–up, 2–27  
PRG\_CHK, 2–22  
Privilege level change requests, 2–32  
Privilege levels, 2–31  
    change requests, 2–32  
Program block  
    how subroutines are called, 2–17  
    subroutine block, 2–15  
Program block checksum failure, 3–12  
Program organization and user data, floating-point numbers, E–1  
Program organization and user references/data, 2–15  
    data types, 2–21  
    function block structure, 2–24  
    retentiveness of data, 2–20  
    system status, 2–22  
    transitions and overrides, 2–20  
    user references, 2–18  
Program structure  
    how subroutines are called, 2–17  
    subroutine block, 2–15  
Program sweep, standard, 2–2  
Programmer communications window, 2–9

Programming instructions, 4-1  
  bit operation functions, 4-40  
  control functions, 4-90  
  conversion functions, 4-82  
  data move functions, 4-60  
  instruction mnemonics, C-1  
  math functions, 4-23  
  relational functions, 4-35  
  relay functions, 4-2  
  table functions, 4-75  
  timers and counters, 4-9  
Proportional Integer Deviation (PID), 4-123

## R

RAD, 4-34  
Radian conversion function, 4-34  
RANGE, 4-37  
Range function, 4-37  
REAL  
  convert to REAL, 4-86  
  Data type structure, 2-21  
  Using floating-point numbers, E-1  
  Using Real numbers, E-1  
Register Reference, system registers, 2-18  
Register references, 2-18  
  analog inputs, 2-18  
  analog outputs, 2-18  
Relational functions, 4-35  
  EQ, 4-35  
  GE, 4-35  
  GT, 4-35  
  LE, 4-35  
  LT, 4-35  
  NE, 4-35  
  RANGE, 4-37  
Relay functions, 4-2  
  coils, 4-2, 4-4  
  contacts, 4-2  
  continuation coil, 4-8  
  continuation contact, 4-8  
  horizontal and vertical links, 4-7  
  negated coil, 4-4  
  negated retentive coil, 4-4  
  negative transition coil, 4-5  
  normally closed contact, 4-3  
  normally open contact, 4-3  
  positive transition coil, 4-5

  RESET coil, 4-6  
  retentive coil, 4-4  
  retentive RESET coil, 4-7  
  retentive SET coil, 4-6  
  SET coil, 4-5  
RESET coil, 4-6  
Reset of, addition of, or extra, option module,  
  3-10  
Retentive coil, 4-4  
Retentive RESET coil, 4-7  
Retentive SET coil, 4-6  
Retentiveness of data, 2-20  
ROL, 4-49  
ROR, 4-49  
Rotate left function, 4-49  
Rotate right function, 4-49

## S

Scan Time Contributions for 351 CPUs, 2-6  
Scan time contributions for module types, 2-5  
Scan, input, 2-8  
Scan, output, 2-8  
Search array move function, 4-76  
Search equal function, 4-79  
Search greater than function, 4-79  
Search greater than or equal function, 4-79  
Search less than function, 4-79  
Search less than or equal function, 4-79  
Search not equal function, 4-79  
Security, system, 2-31  
  locking/unlocking subroutines, 2-32  
  passwords, 2-31  
  privilege level change requests, 2-32  
  privilege levels, 2-31  
Service Request  
  interrogate I/O, 4-121  
  read elapsed power down time, 4-122  
  read master checksum, 4-120  
Service request function, 4-104  
SET coil, 4-5  
SFT\_CPU, 2-23

- SFT\_FLT, 2–23
- SFT\_SIO, 2–23
- SHFR, 4–66
- Shift left function, 4–47
- Shift register function, 4–66
- Shift right function, 4–47
- SHL, 4–47
- SHR, 4–47
- Signed integer, 2–21
- SIN, 4–30
- Sine function, 4–30
- Software failure, option module, 3–11
- SQRT, 4–29
- Square root function, 4–29
- SRCH\_EQ, 4–79
- SRCH\_GE, 4–79
- SRCH\_GT, 4–79
- SRCH\_LE, 4–79
- SRCH\_LT, 4–79
- SRCH\_NE, 4–79
- Standard program sweep mode, 2–2
- Standard program sweep variations, 2–11
- Status references, system, 2–19 , 2–22
- STOP mode, 2–12
- STOR\_ER, 2–23
- SUB, 4–23
- Subroutine blocks, 2–15
- Subroutines, locking/unlocking, 2–32
- Subtraction function, 4–23
- SVCREQ, 4–104
  - change/read task state and number of words to checksum, 4–106
  - change/read time-of-day clock, 4–109
  - clear fault table, 4–114
  - interrogate I/O, 4–121
  - read elapsed power down time, 4–122
  - read elapsed time clock, 4–118
  - read I/O override status, 4–119
  - read last-logged fault table entry, 4–115
  - read master checksum, 4–120
  - shut down (stop) PLC, 4–113
- Sweep time calculation, 2–7
- Sweep, PLC, 2–1
  - application program logic scan, 2–8
  - constant sweep time mode, 2–11 , 2–30
  - housekeeping, 2–8
  - input scan, 2–8
  - logic program checksum calculation, 2–9
  - logic solution, 2–8
  - output scan, 2–8
  - PCM communications with the PLC, 2–11
  - programmer communications window, 2–9
  - scan time contributions, 2–5
  - scan time contributions for 351 CPUs, 2–6
  - standard program sweep mode, 2–2
  - standard program sweep variations, 2–11
  - STOP mode, 2–12
  - sweep time calculation, 2–7
  - sweep time contribution, 2–4
  - system communications window, 2–10
- SY\_FLT, 2–23
- SY\_FULL, 2–22
- SY\_PRES, 2–23
- System communications window, 2–10
- System configuration mismatch, 3–11
- System operation, 2–1
  - Alspa C80–05 PLC I/O system, 2–34
  - Alspa C80–25 PLC I/O system, 2–34
  - Alspa C80–35 PLC I/O system, 2–34
  - clocks and timers, 2–29
  - PLC sweep summary, 2–1
  - power-up and power-down sequences, 2–27
  - program organization and user references/data, 2–15
  - system security, 2–31
- System references, 3–5
- System register references, 2–18
- System status references, 2–19 , 2–22
  - ADD\_IOM, 2–23
  - ADD\_SIO, 2–23
  - ALW\_OFF, 2–22
  - ALW\_ON, 2–22
  - ANY\_FLT, 2–23
  - APL\_FLT, 2–23
  - BAD\_PWD, 2–23
  - BAD\_RAM, 2–23
  - CFG\_MM, 2–23
  - FST\_SCN, 2–22
  - HRD\_CPU, 2–23
  - HRD\_FLT, 2–23

HRD\_SIO, 2–23  
IO\_FLT, 2–23  
IO\_FULL, 2–22  
IO\_PRES, 2–23  
LOS\_IOM, 2–23  
LOS\_SIO, 2–23  
LOW\_BAT, 2–23  
LST\_SCN, 2–22  
OV\_SWP, 2–23  
OVR\_PRE, 2–22  
PB\_SUM, 2–23  
PLC\_BAT, 2–22  
PRG\_CHK, 2–22  
SFT\_CPU, 2–23  
SFT\_FLT, 2–23  
SFT\_SIO, 2–23  
STOR\_ER, 2–23  
SY\_FLT, 2–23  
SY\_FULL, 2–22  
SY\_PRES, 2–23  
T\_100MS, 2–22  
T\_10MS, 2–22  
T\_MIN, 2–22  
T\_SEC, 2–22

## T

T\_100MS, 2–22  
T\_10MS, 2–22  
T\_MIN, 2–22  
T\_SEC, 2–22  
Table functions, 4–75  
  ARRAY\_MOVE, 4–76  
  search less than or equal function, 4–79  
  SRCH\_EQ, 4–79  
  SRCH\_GE, 4–79  
  SRCH\_GT, 4–79  
  SRCH\_LT, 4–79  
  SRCH\_NE, 4–79  
TAN, 4–30  
Tangent function, 4–30  
Temporary references, discrete, 2–19  
Time-of-day clock, 2–29  
Time-tick contacts, 2–30  
Timers, 2–29, 4–9  
  constant sweep timer, 2–30

function block data, 4–9  
OFDT, 4–15  
ONDTR, 4–10  
time-tick contacts, 2–30  
TMR, 4–13  
  Watchdog timer, 2–30

Timing, instruction, A–1

TMR, 4–13

Transitions, 2–20

Troubleshooting, 3–1

  accessing additional fault information, 3–8  
  CTRL–F to display hexadecimal fault information, 3–8, B–3, B–9  
  hexadecimal display of fault information, 3–8, B–3, B–9  
  I/O fault table, 3–7  
  I/O fault table explanations, 3–18  
  interpreting a fault, B–1  
  non-configurable faults, 3–10  
  PLC fault table, 3–6  
  PLC fault table explanations, 3–9

TRUN, 4–88

Truncate function, 4–88

## U

Up counter, 4–18  
UPCTR, 4–18  
User references, 2–18  
  analog inputs, 2–18  
  analog outputs, 2–18  
  discrete inputs, 2–19  
  discrete internal, 2–19  
  discrete outputs, 2–19  
  discrete references, 2–19  
  discrete temporary, 2–19  
  global data, 2–19  
  register references, 2–18  
  system references, 3–5  
  system registers, 2–18  
  system status, 2–19, 2–22

## V

Vertical link, 4–7  
VIEWLOCK, 2–32

## **W**

Watchdog timer, 2–30

Window, 2–9

  programmer communications window, 2–9

  system communications window, 2–10

WORD, 2–21, 4–87

## **X**

XOR, 4–44