

6247BP10720

New In Stock!

ABB

<http://www.pdfsupply.com/automation/abb/623-624-series/6247BP10720>

623-624-series

1-919-535-3180

Electronic Assembly for 6247BP10710

www.pdfsupply.com

Email: sales@pdfsupply.com

Specifications

Block Type:	16 circuits, inputs only
Catalog Numbers:	
115VAC 16 Circuit Input Block	IC660BBD110
Terminal Assembly Only	IC660TBD110
Electronics Assembly Only	IC660EBD110
Size (height x width x depth):	8.83" (22.44cm) x 3.50" (8.89cm) x 3.94" (10.00cm)
Weight:	4 lbs. (1.8 Kg)
LEDs (I/O block):	Unit OK, I/O Enabled
LEDs (each circuit):	Reflect state of input (logic side)
Input to ground (or serial bus) isolation	1500V
Terminal board rating (input or feedthrough current)	5.0 Amps
Heat Dissipation:	28 Watts maximum with 16 inputs on at full current.
Operating voltage:	93–132 VAC
Frequency:	47–63 Hz
Required power (block only):	80mA maximum block current, plus 200mA maximum input circuit current
Power Supply Dropout Time:	1 cycle (16.7mS at 60 Hz/20mS at 50 Hz)
Input Characteristics:	
Input off state, input on state	Programmable threshold (25% to 85%)
Input impedance (typical)	11.6Kohms
Input open wire	Programmable threshold (25% to 85%)
Input shorted wire	Fixed 10%–90% thresholds
Input processing time (typ)	1mS (plus selectable filter time)
Selectable input filter times	10 to 100mS in 10mS increments
Input diagnostics	Open Wire, Short Circuit
Environmental:	
Operating temperature	0C to +60C (32F to +140F)
Storage temperature	–40C to +100C (–40F to +212F)
Humidity	5% to 95% (non-condensing)
Vibration	5–10 Hz 0.2" (5.08mm) displacement, 10–200 Hz at 1G

Block Operation

The input circuitry is resistive. The resistive load is sufficient to activate most 2-wire proximity switch devices. Input resistance is 11.6K ohms, which provides a preload current of 9.9 mA at 115 volts.

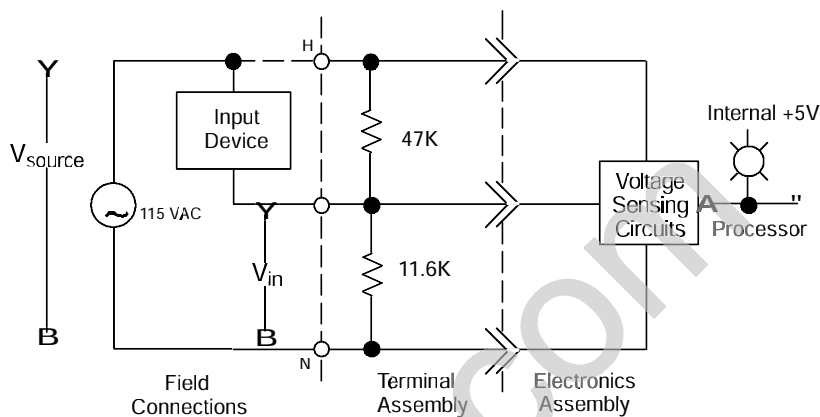

Circuit LEDs

Each circuit has its own LED that indicates the presence of On/Off threshold voltage.

Input Data Format

A 115 VAC 16 Circuit Input Block broadcasts 2 bytes of input data each bus scan. Appendix B shows reference usage for a Series 90, Series Six, or Series Five PLC.

Byte #	Description
0	Inputs 1 - 8 (input 1 in bit 0)
1	Inputs 9 - 16 (input 9 in bit 0)

The block uses 16 input references and no output references. The value 1 in a bit indicates that the input is at or above its configured threshold voltage. Each bank of 8 inputs can have a different On/Off threshold. The factory configured default On/Off thresholds are 50% of the incoming line voltage. The default is suitable for most applications, or it can be changed within the range of 25% to 85% of the incoming voltage.

Hand-held Monitor Input Display

The HHM displays the current states of all inputs on line 4 of the Monitor Block screen

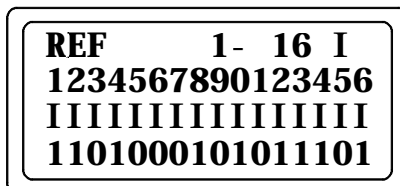

Individual circuits are displayed on the Monitor/Control Reference screen (which also shows a circuit's fault status).

Optional Diagnostics

115VAC 16 Circuit Input blocks can be configured to perform Open Wire and Shorted Wire detection on any circuit. These diagnostics are optional; for a new block, both are disabled.

Open Wire Detection

If Open Wire Detection is enabled, the block monitors three voltage levels to sense On/Off/Open Wire conditions. To use this diagnostic, the Open Wire detection feature must be enabled for the circuit during configuration and resistance must be added across the terminals of the input device during installation.

With the switch closed, the circuit senses a low source impedance. With the switch open, it sees the resistor (R_p in the illustration below). If a wire is broken, cut, or removed the circuit sees a high impedance. The block then transmits 0 as the state of the input, and sends an OPEN WIRE message.

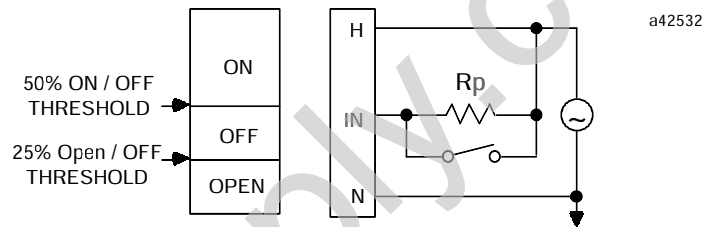

The resistor used for R_p must be compatible with the block's thresholds. For dry contact sensors, the default thresholds are not changed, and a 22K ohm resistor can be used for R_p .

Shorted Wire Detection

This option establishes four voltage levels for On/Off/Short Hi/Short Low. A series resistor (R_s , below) near the input device allows the block to detect a shorted wire from a dry contact sensor to the input terminal high or neutral. Result: Block sets input state to 1 for short high or 0 for short low and issues a Short Circuit diagnostic.

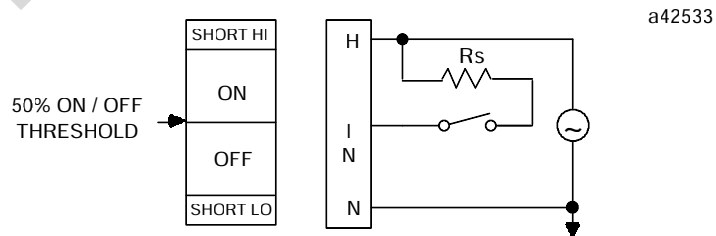

With the switch closed, the circuit senses the resistor. With the switch open, the circuit sees a high impedance. If the input is shorted to the high or low side of the line, the circuit sees a low impedance. Short low and high limits are 10% and 90% respectively. R_s must be compatible with the thresholds. For the default thresholds and a dry contact input, use a 3.9K ohm resistor for R_s .

Using Open Wire and Shorted Wire Diagnostics Together

Open Wire and Shorted Wire diagnostics can be selected for the same circuit. The circuit must include both a series resistor (R_S) and a parallel resistor (R_P) to detect Open/Short conditions from a dry contact sensor. For the default thresholds, use a 3.9K ohm resistor for R_S and a 22K ohm resistor for R_P .

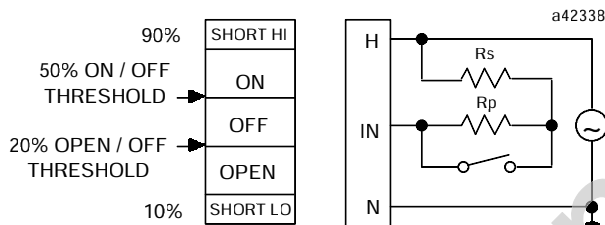

If sensors with non-zero voltage On state drop or non-zero Off state leakage current are used, the On/Off and Open/Off thresholds can be changed. This flexibility provides diagnostics capability with a wide range of sensors. Some solid state sensors may not require additional external resistance to be used. Consult the sensor manufacturer's specifications.

Selecting Thresholds and Resistor Values

For most applications, the default threshold levels and recommended resistor values are not changed. However, the ability to select thresholds extends the use of Open Detect and/or Short Detect diagnostics to circuits with many types of input devices and sensors. To obtain the diagnostic information, resistors must be located in the circuit as previously described. The bias levels these resistors provide to the block must be compatible with the thresholds selected for each bank of eight inputs.

Selecting Thresholds

If a solid state sensor is being used and Open Wire or Shorted Wire detection is required, follow the procedure below.

1. Wire the sensor to the input block and apply power.
2. Measure V_{SOURCE} .
3. Measure V_{IN} with the sensor in the Off state.
4. Measure V_{IN} with the sensor in the On state.

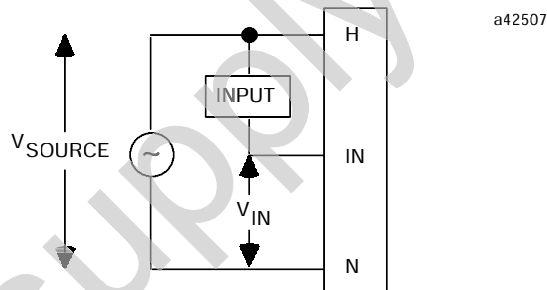

5. Configure the On/Off and Open/Off thresholds so that V_{IN} in the On state and V_{IN} in the Off state are within the proper limits.

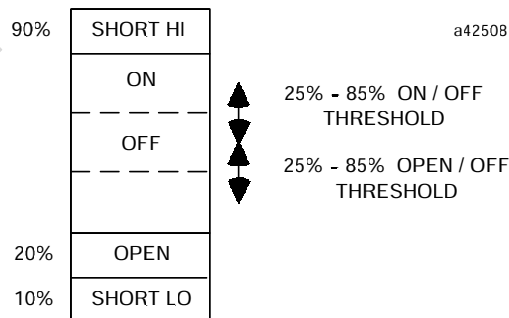

For example, if V_{IN} with the sensor on is 70% and V_{IN} with the sensor OFF is 40%, then the On/Off threshold can be set for 50% and the Open/Off threshold can be set for 25%.

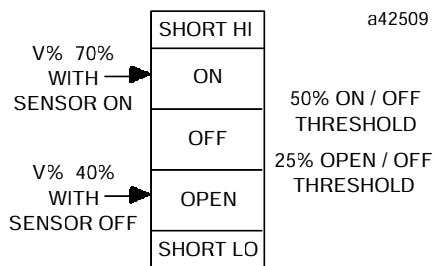

If the resulting V% is too close to a threshold, then reconfigure the threshold to a appropriate operating margin for the circuit.

If the thresholds cannot be selected so that V% with the sensor on and off falls within proper ranges, then external resistors must be added to the circuit. If external resistors are already wired into the circuit, then their values must be changed.

PDFSupply.com

Selecting Resistor Values

Accurate values for R_S and R_P cannot typically be directly calculated because more information is required about the sensor than may be readily available. An estimate and test method can be used to select proper resistance values for R_S and R_P . After R_S and R_P values are estimated, appropriate ON/OFF and Open/Off thresholds should be configured. If the thresholds cannot be selected so that V% with the sensor on and off fall within proper ranges, then the external resistor values must be changed.

Bias voltage levels can be calculated when the external resistance between H and IN is known:

$$V\% = \frac{(11.6 \times R_T) + 545.2}{(58.6 \times R_T) + 545.2}$$

In this equation, V% is the bias level (V_{IN}/V_{SOURCE}). V% with the sensor on and V% with the sensor off must be calculated.

R is the total resistance in the external circuit in K ohms. If the resistors are already in the circuit, actual V% can be found using a voltmeter.

$$R_T = R_S + \frac{(R_P \times R_{INPUT})}{R_P + R_{INPUT}}$$

R_{input} is the equivalent resistance of the sensor. This value of R_{input} will be different in the on state and off state of the sensor. R_{input} will not typically be readily available from the sensor manufacturer.

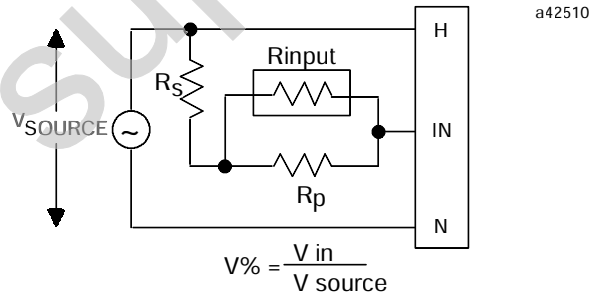

Calculating Resistor Values when V% is Known

If V% in the On state and V% in the Off state are known, resistor values can be found with the following equation.

$$R_T = \frac{545.2 - (V\% \times 545.2)}{(V\%) \times 58.6 - 11.6}$$

Field Wiring

Terminals 5 – 32 are for field devices. They take a single wire up to AWG #14. Minimum recommended size is AWG #20.

Power Source Wiring

Connect the hot side of a 115 VAC source to an H terminal and the neutral to an N terminal.

The power supply should not be fused higher than 5 amps.

Caution

Do not daisy-chain the power bus to other blocks through the extra H and N terminals. These terminals are for wiring convenience only; using them as power distribution points may result in damage to the block.

Block Power Disconnects

Since block power is the same as circuit power, it is important to wire block power disconnects so that block power and input power will be removed at the same time.

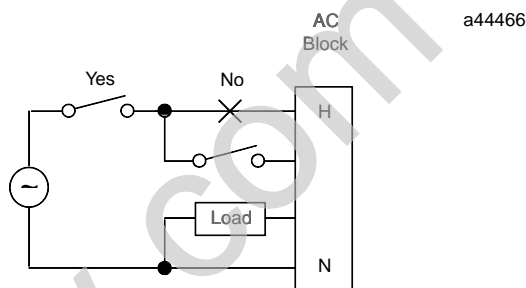

Caution

If the power disconnect does not remove circuit power and block power at the same time, the block may power up when multiple inputs are activated, even though one leg of power has been removed.

Caution

Make all power connection in the block to the same 120 VAC phase. Other blocks can use different phases.

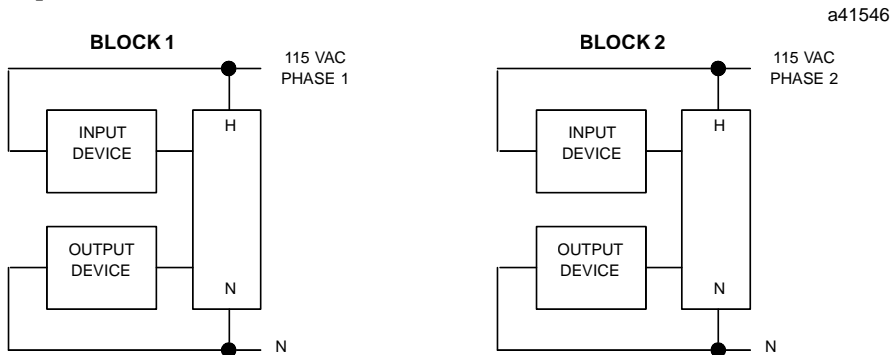

Wiring for I/O Devices

Run one signal wire for each device. Returns can be made to one or more of the H terminals; all H terminals are internally bussed, as are the N terminals. Extra power terminals are for convenience. Depending on layout and current loads, hot connections can be bussed together and made by one wire back to the block or power source. Neutral connections can also be bussed and made with one wire.

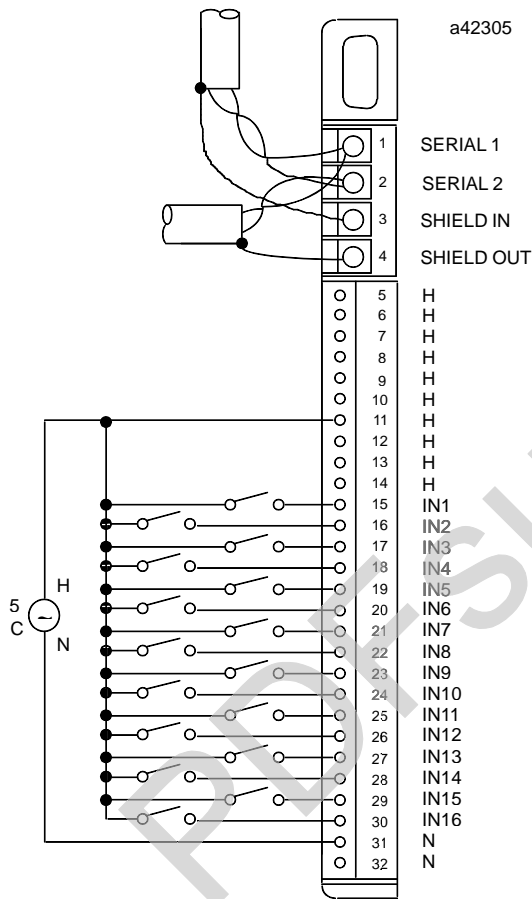

Wiring for Shorted Wire Detection

For any circuit which is configured to use the Shorted Wire detection option, install an appropriate resistor in series with the input device. Selection of a resistor depends on the configuration. See page 6-4.

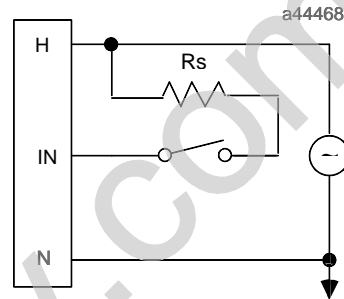

Wiring for Open Wire Detection

For any circuit which is configured to use the Wire detection option, install an appropriate resistor across the terminals of the input device. Selection of a resistor depends upon the configuration. See page 6-4.

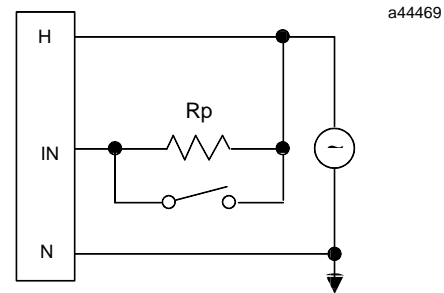

Open Wire and Shorted Wire diagnostics can be selected for the same input. The input circuit must then include both a series resistor and a parallel resistor to detect Open/Short conditions from a dry contact sensor. See page 6-5.

Block Configuration

The configurable features of a 115 VAC 16 Circuit Input Block are listed below. For many, the factory setting may not need to be changed.

Feature	Circuit or Block	Factory Setting	Selections
Device Number*	Block	null	0 to 31 (a number must be selected)
Reference Address*	Block	none	Depends on host CPU type
Baud Rate*	Block	153.6 std	153.6 std, 153.6 ext, 76.8, 38.4 Kbd
Input Filter Time	**	10mSec	10–100mSec in 10mS steps
Open/OFFthreshold	**	25%	25%–85%
ON/OFFthreshold	**	50%	25%–85%
Shorted Wire Detect	Circuit	no	yes, no
Open Wire Detect	Circuit	no	yes, no
Report Faults*	Circuit	yes	yes, no
Configuration Protection	Block	disabled	enabled, disabled

** Set up separately for each bank of 8 circuits.

Features marked with one asterisk in the table are configured from the Program Block ID screen of the Hand-held Monitor, as explained in chapter 3.

The rest of the features can be configured either using a Hand-held Monitor, or by sending a Write Configuration datagram to the block from the host.

Before configuration begins, the block's features should be decided on and recorded on copies of the Configuration Worksheet printed on the next page.

16 Circuit AC Input Block Configuration Worksheet

Block _____ Location _____

Block Features:

Configuration Protected (Y/N) _____

Block Number (0–31) _____ Reference Address _____ through _____

Baud Rate (153.6 Kb Std/153.6 Kb Ext/76.8 Kb/38.4 Kb) _____

Input Filter Time (10–100 mS): circuits 1–8 _____ circuits 9–16 _____

Open/OFF Threshold: circuits 1–8 _____ circuits 9–16 _____ % of line voltage

ON/OFF Threshold: circuits 1–8 _____ circuits 9–16 _____ % of line voltage

Circuit Features:

	Reference Address	Report Faults (yes?no)	Enable Shorted Wire Detect (yes/no)	Enable Open Wire Detect (yes?no)
1	_____	_____	_____	_____
2	_____	_____	_____	_____
3	_____	_____	_____	_____
4	_____	_____	_____	_____
5	_____	_____	_____	_____
6	_____	_____	_____	_____
7	_____	_____	_____	_____
8	_____	_____	_____	_____
9	_____	_____	_____	_____
10	_____	_____	_____	_____
11	_____	_____	_____	_____
12	_____	_____	_____	_____
13	_____	_____	_____	_____
14	_____	_____	_____	_____
15	_____	_____	_____	_____
16	_____	_____	_____	_____

Input Filter Time

The block continuously samples an input for the length of the configured filter time period. If the input remains either on or off for the length of the Filter Time, the block recognizes its state. For example:

a42504

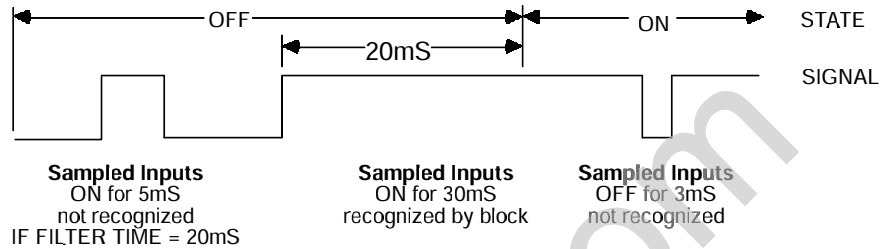

An input filter helps reject spurious noise spikes and multiple inputs generated by the bounce of mechanical devices. An input filter time of 10mS to 100mS can be selected for the block. The default filter time is 10mS (no filter).

In controlled, noise-free environments, signals generated by clean, solid state electronics may be unnecessarily slowed by a filter, delaying system response. In such an environment, no additional filter time is needed.

In noisy environments, use a longer filter time to prevent noise from possibly causing erratic or unsafe system operations.

For a block with tristate inputs, the minimum recommended Input Filter Time is 50mS.

Hand-held Monitor Configuration Steps

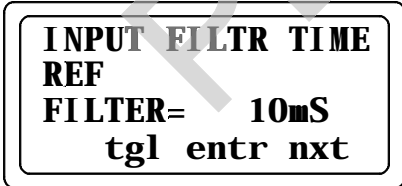

1. The screen displays the selected filter time for circuits 1 - 8. If this is not appropriate, press F2 (tgl) to change it. To save the new selection, press F3 (entr).
2. Press F4 (next) to configure the filter time for circuits 9 - 16. If the time shown is not appropriate, press F2 to change it.
3. Press F4 (next) to advance to the next configuration display.

Thresholds

On this block, each group of eight circuits has two voltage thresholds: an On/Off threshold and an optional Open/Off threshold.

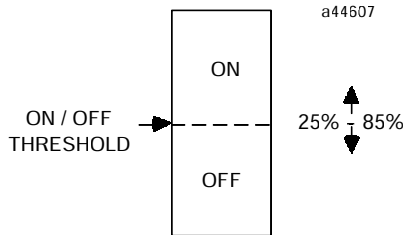

On/Off Threshold: The On/Off threshold determines when inputs are considered to be On or Off. The default On/Off threshold is 50% of the incoming line voltage. This threshold is suitable for most applications. If necessary, a different On/Off threshold can be configured for each group of eight circuits. The selectable range is 25% to 85% of incoming line voltage in 5% increments.

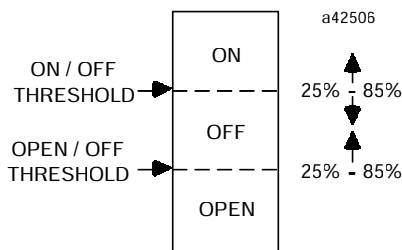

Open/Off Threshold: The optional Open/Off threshold is used if the Open Wire diagnostic is enabled for any input in a group. Detection of open wire conditions requires a resistor across the terminals of the input device.

The default Open/Off threshold for each group of 8 inputs is 25% of the incoming line voltage. If necessary, it can be reconfigured in 5% increments from 25% to 85%.

Hand-held Monitor Configuration Steps

```

THRESHOLDS (%)
REF 1 - 8 I
OPEN: 35 ON: 65
> tgl entr nxt
    
```

1. The screen displays the configured Open Threshold and On Threshold for the first 8 inputs. If Open Wire detection is **NOT** enabled, **XX** will appear beside the word **OPEN**. Details of selecting appropriate Thresholds were given above.

The F1 (>) key moves the cursor between **OPEN** and **ON**.

2. Enter a new Open and/or On Threshold from the keypad. The Open/Off threshold must be less than the On/Off threshold for accurate input data and diagnostics.
3. Press F3 (enter) to save the new Threshold(s).
4. Pressing F4 (next) displays the Threshold configuration screen for the second group of 8 inputs. These may be changed in the same manner.
5. Press F4 (next) to advance to the next configuration display.

Report Faults to CPU

Fault reports to the host can be disabled or enabled for any circuit.

If fault reporting is enabled, the block sends a message to the host if any fault occurs on that circuit. If fault reporting is disabled, the block does not send fault reports to the CPU for that circuit.

Regardless of whether fault *reporting* is enabled, the block detects faults on the circuit, and takes appropriate action. The Unit OK LED blinks when a fault occurs, and a fault report is sent to a Hand-held Monitor. The fault condition must be corrected for proper operation of the block.

The application program can query the block for faults whether or not diagnostics reporting is enabled, using individual Read Diagnostic messages.

HMM Hand-held Monitor Configuration Steps

```

REPORT FAULTS ?
REF
Y Y Y Y Y Y Y Y
  tgl entr nxt

```

1. The screen shows the current Fault Reports configuration of all circuits on the block.
2. To select a circuit, press F1 (>).
3. To change the Report Faults configuration of the selected circuit, press F2 (tgl). To save the new selection, press F3 (entr).
4. Press F4 (next) to advance to the next configuration display.

Shorted Wire Detection

The Shorted Wire Detection feature causes the block to issue a Short Circuit message if the voltage level on an input reaches 10% (short low) or 90% (short high) of the incoming line voltage.

Shorted Wire Detection can be independently enabled for each of the block's 16 inputs. For a new block, it is not enabled for any input. To detect shorted wire conditions, a series resistor must be located near the input device, as explained on page 6-4.

Hand-held Monitor Configuration Steps

```

SHORT DETECTION
REF
NNNNNNNNNNNNNNNN
> tgl entr nxt

```

1. The screen shows whether Short Detection is enabled (Y) or not enabled (N) for each input.
2. To change the cursor location, press F1 (>). To change a selection, press F2 (tgl). To save the new selection, press F3 (entr).
3. Press F4 (next) to advance to the next configuration display.

Open Wire Detection

With Open Wire Detection enabled for an input, the block reports an open wire condition if the input's voltage reaches its Open/Off threshold level (see page 6-14). For a new block, this diagnostic is not enabled for any input. Detection of open wire conditions requires a resistor across the terminals of the input device, as shown on page 6-4.

Hand-held Monitor Configuration Steps

```
OPEN WIRE DETECT
REF
NNNNNNNNNNNNNNNNNN
> tgl entr nxt
```

1. The screen shows whether Open Wire Detection is enabled (Y) or not (N) for each input. To change the cursor location, press F1 (>).
2. To change a selection, press F2 (tgl). To save the new selection, press F3 (entr).
3. Press F4 (next) when you are ready to advance to the next configuration display.

Configuration Protection

After the block is configured, its Configuration Protection should be enabled to prevent unwanted changes (from a Hand-held Monitor and from the CPU). Configuration Protection can only be set and removed by a Hand-held Monitor. For a new block, Configuration Protection is disabled.

Hand-held Monitor Configuration Steps

```
CONFIG PROTECT
REF
DISABLED
  tgl entr nxt
```

1. To change the current selection, press F2 (tgl).
2. Press F3 (entr) to save the new selection.
3. Press F4 (next) to return to the first configuration display.